



This is a digital copy of a book that was preserved for generations on library shelves before it was carefully scanned by Google as part of a project to make the world's books discoverable online.

It has survived long enough for the copyright to expire and the book to enter the public domain. A public domain book is one that was never subject to copyright or whose legal copyright term has expired. Whether a book is in the public domain may vary country to country. Public domain books are our gateways to the past, representing a wealth of history, culture and knowledge that's often difficult to discover.

Marks, notations and other marginalia present in the original volume will appear in this file - a reminder of this book's long journey from the publisher to a library and finally to you.

### **Usage guidelines**

Google is proud to partner with libraries to digitize public domain materials and make them widely accessible. Public domain books belong to the public and we are merely their custodians. Nevertheless, this work is expensive, so in order to keep providing this resource, we have taken steps to prevent abuse by commercial parties, including placing technical restrictions on automated querying.

We also ask that you:

- + *Make non-commercial use of the files* We designed Google Book Search for use by individuals, and we request that you use these files for personal, non-commercial purposes.
- + *Refrain from automated querying* Do not send automated queries of any sort to Google's system: If you are conducting research on machine translation, optical character recognition or other areas where access to a large amount of text is helpful, please contact us. We encourage the use of public domain materials for these purposes and may be able to help.
- + *Maintain attribution* The Google "watermark" you see on each file is essential for informing people about this project and helping them find additional materials through Google Book Search. Please do not remove it.
- + *Keep it legal* Whatever your use, remember that you are responsible for ensuring that what you are doing is legal. Do not assume that just because we believe a book is in the public domain for users in the United States, that the work is also in the public domain for users in other countries. Whether a book is still in copyright varies from country to country, and we can't offer guidance on whether any specific use of any specific book is allowed. Please do not assume that a book's appearance in Google Book Search means it can be used in any manner anywhere in the world. Copyright infringement liability can be quite severe.

### **About Google Book Search**

Google's mission is to organize the world's information and to make it universally accessible and useful. Google Book Search helps readers discover the world's books while helping authors and publishers reach new audiences. You can search through the full text of this book on the web at <http://books.google.com/>

RESEARCH LIBRARIES



3 06642407 2











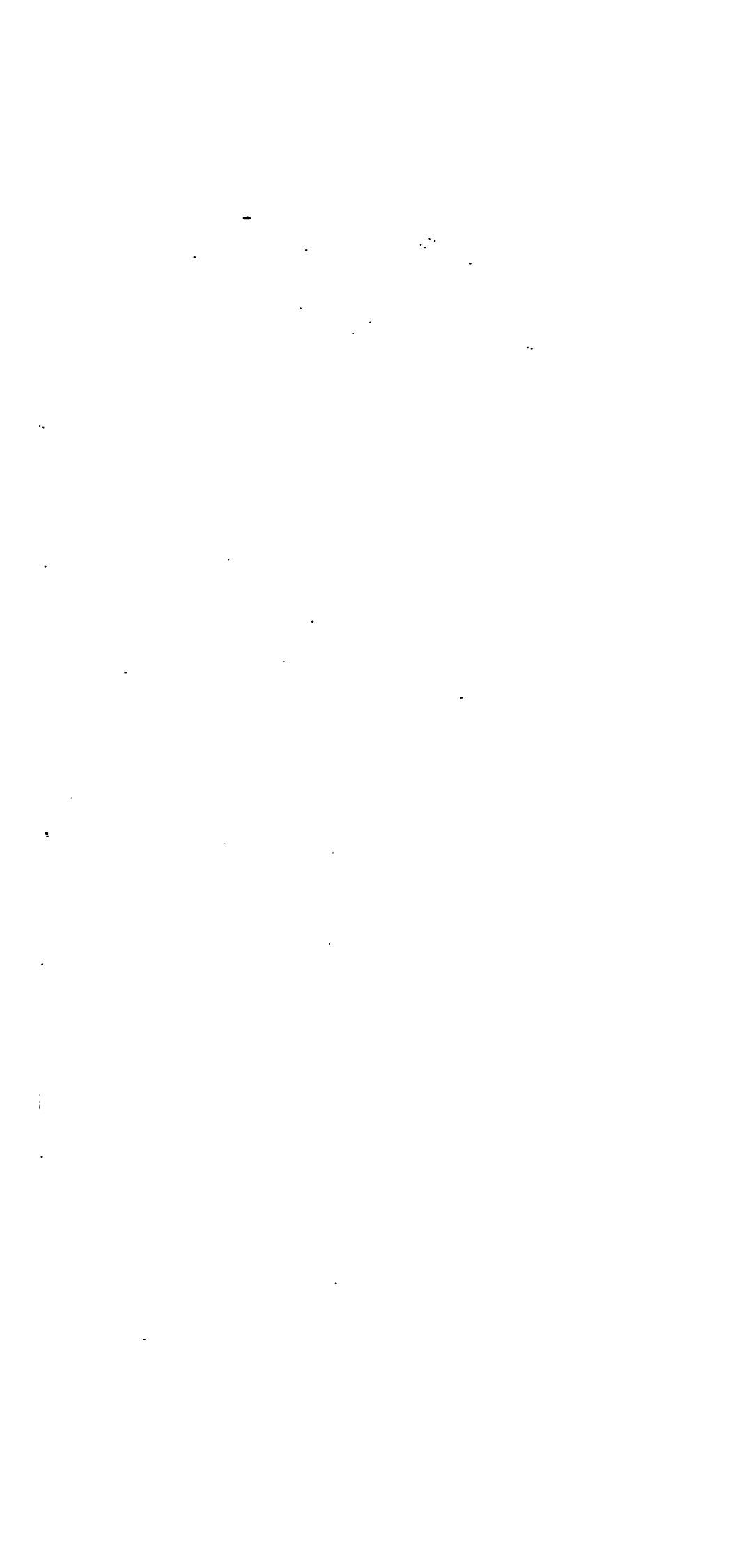



3/19/41

U. E. S. DUPLICATE

621.34  
Am 31

( High )  
N-C-N







U. E. S. DUPLICATE

62,1.34  
Am 31

( High )  
VGA



21.34

Have vol I, 1905

u31

International Electrical Congress, 6th, July 21.22

Lace

HIGH-TENSION

St. Louis, 1904

POWER TRANSMISSION

SECOND VOLUME

A Series of Papers and Discussions Presented at the International Electrical Congress in St. Louis, 1904

REPUBLISHED BY THE  
McGRAW PUBLISHING COMPANY  
NEW YORK

By Special Arrangement with the  
International Electrical Congress

1906

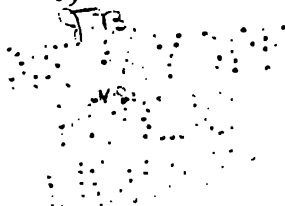

THE NEW YORK  
PUBLIC LIBRARY  
**53924A**  
ASTOR LENOX AND  
TILDEN FOUNDATION  
1906

**COPYRIGHTED, 1906**  
by the  
**McGRAW PUBLISHING COMPANY,**  
New York.





**ELECTRIC POWER TRANSMISSION COMMITTEE**

**1904**

*Honorary Chairmen*, M. PAUL JANET AND ING. A. MAFFEZINI.

*Chairman*, MR. CHAS. F. SCOTT.

*Vice-President*, ING. E. JONA.

*Secretary*, DR. LOUIS BELL.

11335

house and line, but would vary greatly in many details of construction.

These latter, therefore, constitute that part of the art which is somewhat indeterminate and on which more light is needed. Nevertheless these papers form a body of precedent from which, as in legal affairs, valuable information may be secured. It would be unfortunate, however, if precedent in engineering matters were given the weight that attaches to it in jurisprudence. In engineering there is neither any Supreme Court nor body of common law handed down from an earlier civilization. In fact a period of standardization generally implies cessation of improvement. But it is often a good thing to go back in case of doubt to original sources of information like these and to see what decisions were reached by skilled men in dealing with the conditions that confronted them. And all these papers have the value that comes of personal contact with the subjects considered. It would be invidious, therefore, to attempt at the moment any comparison between them. They represent a growing art, which can be successfully followed up only by reading attentively of progress as it is made. Herein lies the value of the present volume, that it gathers from a source not always conveniently accessible the best judgments of experts regarding some highly important topics, delivered at a recent date, and puts them all together where they can be consulted when necessary. There is not one of them but will repay careful study, and their aggregate forms a sort of landmark in the art from which the bearings of future progress may be taken.

LOUIS BELL.

BOSTON, MASS.

# CONTENTS

---

	PAGE.
Electrical power transmission .....	1
The high-tension transformer in long-distance power transmission...	9
Notes on experiments with transformers for very high potentials.....	25
High potential, long distance transmission and control.....	31
American practice in high-tension line construction and operation....	67
Spark distances corresponding to different voltages.....	82
The use of aluminum as an electrical conductor.....	101
Conductors for long spans .....	119
High-tension insulators .....	136
The construction and insulation of high-tension transmission lines....	152
Some difficulties in high-tension transmission and methods of mitigat- ing them .....	177
Pioneer work on the Telluride Power Company .....	198
Bay Counties Power Company's transmission system.....	215
Some practical experiences in the operation of many power plants in parallel . .....	231
Maximum distance to which power can be economically transmitted..	252
Some elements in the design of high-pressure insulation.....	273
Insulating materials in high-tension cables.....	288



## ELECTRICAL POWER TRANSMISSION.

---

BY CHAS. F. SCOTT.

---

The national and international expositions held in America mark certain fairly definite eras in electrical development.

In 1876, at the Philadelphia Centennial, the telephone was announced. There was a dynamo which could supply one arc lamp. One of the features of the exposition was a great engine of 1000 hp.

In 1884 an electrical conference was held in Philadelphia. By this time electric lighting was assuming commercial significance. There were numerous stations supplying arc lights and incandescent lights. Some of these were beginning to pay dividends, marking the passage of the electrical industry from the experimental to the commercial stage. Generally speaking, however, the apparatus was crude and inefficient, there were few stationary motors, the railway motor and the alternating current had no commercial significance.

By 1893, the year of the Columbian Exposition at Chicago, electrical matters were assuming an extended engineering and commercial development. Engine-type generators for alternating and direct current were being introduced. The street-railway motor was just beginning to operate cars heavier than the ordinary street car, although the principal thoroughfare in New York city was starting a cable road. Electrical exhibits were in great prominence at the exposition, but, in looking back over a decade, the most striking feature is that certain things which are now so common were there simply as exhibits.

The rotary converter was a curiosity in 1893. It began its commercial work a few years afterward and did not become a very important element in electrical systems until four or five years later. In a discussion upon power transmission at the Electrical Congress held that summer, an electrical engineer from California made this statement: "I wish to say definitely that to the investor in California to-day, the successful machine for long dis-

tance transmission of power electrically exists only in the minds of the inventors and promoters, or in some beautiful advertisement." There had been in operation for a few years a single-phase transmission of about 200 kw at 10,000 volts a distance of less than 30 miles for lighting. There were a few plants transmitting power by single-phase synchronous motors at voltages of about 3000. Although polyphase generators were in use, there was no plant transmitting polyphase current at high voltage. I remember distinctly a friend announcing to me during the Congress that it had just been officially determined to use polyphase alternating current instead of direct current for the Niagara Falls Power Company. The contract for the Niagara generators was closed several months later. The Folsom-Sacramento transmission, which I believe may be classed as the first polyphase high voltage system in America, was not undertaken until the following year.

In the Congress of 1904, the section which has to do with electric power transmission deals therefore with a branch of engineering which has had its commercial development within the past decade, and, furthermore, the great bulk of that which has commercial value and engineering interest does not date back more than half of that time.

Approximate statistics show that the apparatus manufactured by the leading American companies for power transmission at 10,000 volts or higher provides for the transmission of approximately 1,250,000 hp, all by polyphase current. These striking figures indicate a quantitative or commercial development, which is, however, no more remarkable than the qualitative or engineering development. The elementary diagram of a power transmission system with generator, raising transformers, transmission line and lowering transformers has been developed into great systems with many power-houses, with networks of high-tension circuits connecting many sub-stations, which in turn have distributing circuits with very exacting requirements. Substantially every element in the system from the generator shaft to the incandescent lamp, or motor pulley, has required the constant attention of the designer and engineer. Generator and transformer design, types of windings and of insulation, switchboard, switches, instruments, protective apparatus, insulators, pins and line construction have all passed through many stages of development since the early plants were installed. Each advance in voltage, each increase in power, each increase of distance, each station or sub-station added

to a system has increased former difficulties and has brought forth new ones.

Problems of transmission are not problems which can be solved in the laboratory alone. Apparatus must meet the precise conditions of operation and be judged by experience.

The transmission problem, moreover, is not one pertaining to a single plant. The conditions of climate and of service requirements are varied. That which is successful in one place, and for a given kind of service, may be wholly inadequate elsewhere.

The general engineering problems involved in high-tension transmission are not those for the individual, but, broadly speaking, they are for the engineering profession. We will not succeed by isolation but by cooperation. He who does not contribute to the general fund of experience and he who does not profit by the experience of others is narrow and short-sighted. Competition and rivalry should not limit and restrict progress, but should urge to better attainments. Research and experience, theory and practice must go hand in hand.

Well may we congratulate ourselves upon the progress, both quantitative and qualitative, which has been made in the past decade, but we have reached no limit, no resting place. There is every indication that the growing applications and the demands for power, the enlarging radius which high pressures make practicable will bring more difficult and more exacting problems to the engineer and will lead to results which in future may make our present record simply the small beginnings of what is to follow.

A great impetus was given to the polyphase system when it was adopted by the Niagara Falls Power Company and the selection of 25 cycles, a radical departure from the practice and the prevalent ideas of that time, was effective in making this frequency a recognized standard.

A few facts in connection with the power developments at Niagara Falls are significant and typical. From the first, a large portion, usually the greater part, of the power developed has been consumed by processes or industries which were not yet invented or perfected at the time that the Niagara development was undertaken. The initial installation of the Niagara Falls Power Company consisted of three generators with a combined output of 15,000 hp, although wheel pits were provided for two more units. The first power was delivered commercially in 1895, nine years

ago. Extensions have been rapid. This company has generators aggregating over 100,000 hp installed. Another company is developing 25,000 hp electrically, and plants are now under active construction for an additional output of nearly 500,000 hp.

Many of the electrical questions which are of particular interest at the present time are not broad and general, they are specific and in detail, they are with regard to the particular type, or form of apparatus, or method of construction. In recent conferences with the engineers of three transmission systems I found that each had a particular element in his system which was the source of most of his trouble, and yet, in two of the cases the elements most liable to give rise to trouble caused little or no apprehension in either of the other plants. The difficulties in one place may not be the difficulties in other places. Hence the value of free interchange of experience and of data.

A recent writer has said that the cost of a great exposition might well be borne by the general government as there would be value returned through the indirect impetus given to its citizens. Even from the inspiration given to a single individual there might come results which would justify the whole cost. We have come together for interchange of information and of ideas. Fortunate will we be if, supplementing the mutual helpfulness and assistance which is sure to follow, there may be also an outlining and consideration of the problems of the future. It is well to look to the details of our present apparatus and systems, we must be awake also to the discovery of things which are radically new in materials, in design, in method, which may better solve the problems we now have and which may enable us to enter into new fields.

#### DISCUSSION.

Chairman SCOTT: Let me speak a word on behalf of the officers of this Section. I think the first power transmission which can be considered broadly electric power transmission on a fairly long-distance and definite scale was the one at Telluride, Colorado, a 100-hp. motor operated over a few miles at 3,000 volts. It was my privilege to have much to do with the designing and arrangement of the apparatus and system for that operation, so that I think I take a just pride in having had something to do with the first American power-transmission system. Dr. Bell, our secretary, was at the World's Fair in Chicago on the occasion to which I referred; he was on his way to Redlands, Cal., to put in operation the Redlands plant, which transmitted three-phase currents at twenty-five or twenty-six hundred volts for a distance of eight miles, and was at the time the largest



power transmission. A little later, I think the next year, it was he, if I am correct, who started the Folsom-Sacramento plant which I have classed as the first real polyphase high-tension transmission plant. So that among your officers you have the pioneers in the business.

**Dr. F. A. C. PERRINE:** What was the date of the Standard Consolidated Plant of Bodie?

**Chairman SCOTT:** At Bodie, Cal., a plant, practically a duplicate of the Telluride plant, was put in operation in 1892 or the beginning of 1893.

**Dr. BELL:** A few words in reference to the early state of the art may possibly be of interest to some of the members. I remember very well the first start at polyphase alternating-current transmission. It was in 1892 when the two great rival companies were competing commercially, and both of them struggling with the possibilities of transmission. I remember coming that year to take charge of transmission work for the General Electric Co. and finding as a heritage a contract in Walla Walla, in the state of Washington, for a transmission of five miles, to the amount of about 150 horse-power. At that time, 1892, we were practically lacking in this country any means of doing that work. The heritage had come in the form of a contract for high-voltage direct-current machines and there was at that time in America no manufacturer who would tackle the proposition of making 150 horse-power direct-current machines to transmit power five miles at any kind of efficiency. The proposition as originally brought before me included a 2000-volt machine and there was not a maker in this country who dared wrestle with building a 2000-volt machine of that capacity. The contract had to be filled, and I remember almost the first thing I had to do in taking hold of that transmission work was to find some way of getting out of the difficulty, which was done by using a single-phase lighting machine, 150 kw, at each end, and starting the synchronous motor, which took all the power, by means of throwing the excitors of the two machines at extra high-voltage upon the line and so getting up speed. That plant may be running yet; it was running up to three or four years ago. By the next year, progress had been rapid and the three-phase generators were worked out so that that first Redlands plant was sold in February or March, 1893, and got installed just after the Electrical Congress, without any considerable difficulty. On that occasion, I believe, two three-phasers were commercially worked in parallel for the first time. The plant was sold under a guaranty, stimulated by the engineers of the company of which our honored president has long been the electrical light; a guaranty that required operating in parallel, and I think there was a doubt that lingered in the minds of a good many people as to whether it could be done. A time came when both generators were installed and the president of the company rode up through the canyon on a short hunting trip, and as he went through the station, and saw the preparations made for paralleling the machines, suggested that he would like to see that guaranty fulfilled then and there. I remember taking—not my life but my nerve in my hands, and parallelizing then and there the machines, and, for a wonder, they went together without the slightest difficulty. I say, for a wonder—I knew from experiments in the laboratory they must go together, and I knew perfectly well when they were

synchronized they would go together, but confidentially, I may be here justified in saying that the next two or three times we tried to parallel those machines there was trouble. That was the first of the American polyphase plants, if I possibly except a pair of little generators which were then running in Concord, N. H., aggregating 70 kw or 35 kw apiece. They were machines which had been remodeled from the old single-phasers and had surface-wound armatures, giving 500 volts or thereabouts, and the history of the installation of those two machines may be of interest. Another contract had been taken and was passed on to me at the same time, to-wit: in 1892,— a proposition for transmitting power five miles, in Concord, N. H., for the purpose of running small motors. That contract had been closed with the specification of using two 500-volt generators connected on a three-wire system. After much labor I succeeded in persuading the agents and the buyers to the point of using three-phase apparatus. Some of the three-phase motors were delivered and it was necessary, prior to the installation of the large machines, which was waiting the completion of the dam, to do something toward supplying customers with motors. The company did not desire to put in any more 500-volt continuous-current motors, so two or three—three, I think,— polyphase induction motors—the first in commercial use in this country—were shipped up there and the two little generators were sent up after them and installed in a steam-driven station. Those, I believe, were actually the first polyphase machines which were in use in this country. Somewhat later, another interesting plant was installed, in Taftville, Conn. It was a duplicate of the Redlands plant, practically, on a five-mile transmission, which is not at all notable but at least interesting as being the first transmission for driving railway generators for street-car service. They were driven in connection with other mill machinery by a 250-hp. synchronous motor, the synchronous motor having auxiliary windings in the field and being started as an induction motor. In connection with that plant some of the early difficulties are forcibly brought to mind. There were no insulators at that time adequate for use as pull-off insulators in keeping up the line, and during one whole afternoon we ran the railway and the mills of 1,700 looms with arcs breaking every few minutes across the insulators at the end of the line, while an industrious assistant of mine, perched on an enormous pile of dirt which had been accumulated in the excavation of the tailrace, was making (to use a Hibernianism) snow-balls out of the dirt and throwing them at the insulators to break the arcs. Such were some of the asperities with which we had to contend in the very early days, but those days were, providentially, soon ended.

Mr. E. KILBURN SCOTT: There is an impression in Europe that the adoption of the polyphase alternating current at Niagara followed directly from the success of the Tivoli-Rome installation. I remember going down to see that particular plant soon after it was started, about 1892, and on signing the register, I remember seeing the names of the members of the Niagara commission. I really believe that the instant and complete success of that particular installation had great weight with them. We have

not much to show in England in transmission of power, in the early days, but perhaps I may be allowed to remind you of the pioneer work of Ferranti, when he transmitted power by alternating currents from Deptford to London, eleven miles at 10,000 volts. He proved that it was possible to transmit power at such a high pressure through underground insulated cables. That was a very important thing for us to know. We were not then allowed to run bare high-pressure wires. Our Board of Trade is much more reasonable now, I am glad to say.

Mr. Scott has mentioned that a large amount of transmission work has been done within the last five years, and especially on the Pacific coast. Is not this traceable to the peculiar geographical advantages there? The very high falls enable you to use the tangential water wheel, which is the most beautifully simple, as well as the cheapest, prime mover in the world. The steam-turbine cannot compare with it.

I am now engaged on a plant in North Wales, where we are using power from a lake on Mount Snowdon, and we have a fall there of 1150 feet; but I do not know of such another case in Great Britain. There are two or three others of 900 feet; but they require expensive hydraulic works to develop them. When I came to work out the details of the Snowdon plant, I was specially struck with the simplicity of a plant driven by high-pressure tangential water-wheels. With high falls, the water is generally pure and free from sand, as well as from organisms that cause growth in pipes. On low falls, the water is much more likely to contain organisms, and machines have had to be invented to scrape out the pipes. On the Pacific coast you have pure water, in some cases from glacial streams, and the reason why so much power transmission has centered there is largely due to those high falls.

Chairman SCOTT: The last speaker mentioned one of the geological conditions which has favored our transmissions in California, namely, the mountain ranges and the high falls. There is another which I think has been equally favorable to water-power development, and that is the lack of coal. The cost of fuel is high and water-power is resorted to as a necessity. I noticed when the pure water of California was mentioned as being the only thing to be found there, that our friend Mr. Hutton looked a little dubious. He appeared to be rather surprised at so general a statement.

Mr. R. S. HUTTON: Regarding the pureness of the water, Mr. Chairman, in the winter time, as in any other good country, we have rain. While our rainy season is rather short we have a fair share of it. A good many of our plants are located at points well down on the sides of the mountains, and above such points in earlier times the sides of the mountains have been considerably gouged out by the hydraulic mining processes. This has filled up a great many of the gulches, and left much debris, which the high water has gradually brought down, a little at a time, until we have in connection with our flumes found it necessary to install a very elaborate system of sand-catching basins, and methods of taking care of the conditions existing. Some of the original water-wheels installed, due to the earlier imperfect design and construction, gave considerable trouble in the matter of cutting of the buckets and parts with which the water

came in contact. This to-day has been considerably overcome, so that our wheels give us very little trouble from grit that may be in the water. The nozzles still get some of the effects of the cutting, but this is a small matter and is easily taken care of. Speaking about the high heads we have, just a few days before I left California, we put in operation a 5000-kw unit which, together with its water wheel, forms a very simple and compact design, simply a two-bearing unit, with water wheel overhanging. This unit operates at a speed of 400 revolutions per minute. The head of water used is 1,600 feet and sufficient power is derived from this to drive the generator at considerable over load with a six-inch nozzle. This, as I say, was just put in operation a few days before I left, and we of course do not know precisely what the result is going to be; but from former experience with other units, slightly smaller, we feel that we shall not have a large amount of trouble.

Mr. W. L. WATERS: As modern power transmission usually means three-phase transmission, I think Mr. Kilburn Scott made statements which were to the point when he called attention to the fact that the original polyphase work was done on the other side of the Atlantic. The first polyphase transmission on a commercial scale was the Lauffen transmission at the Frankfort Exposition in 1891, where, I think, 150 hp was transmitted 100 miles, at about 30,000 volts. The work done in the next few years was really single-phase work, and I think I am right in saying that both the Telluride and the Tivoli-Rome plants were single-phase. It was really three or four years later that the Niagara Falls transmission was started up, making the first large important polyphase transmission in this country. Certainly Mr. C. E. L. Brown deserves the credit of the pioneer work in polyphase transmission, and of showing that it was capable of commercial success.

Chairman SCOTT: I should have limited my comment here to work in America; I had that in mind, and in not discussing foreign work I did not mean to belittle it. I will add that limitation in the paper. If there is no further discussion we will adjourn until tomorrow morning.

## THE HIGH-TENSION TRANSFORMER IN LONG-DISTANCE POWER TRANSMISSION.

---

BY JOHN S. PECK.

---

The development of the high-tension transformer has been one of the great factors in the growth of long-distance power transmission which has occurred during the past decade. At the beginning of this period there were practically no transformers in commercial service of a capacity as great as 100 kw, or of a voltage exceeding 10,000. Today there are in America approximately 10,000 transformers of capacities ranging from 100 to 2,500 kw, wound for pressures of 10,000 to 60,000 volts. This development in high-voltage transformers is a direct result of a commercial demand for apparatus capable of transmitting larger and larger amounts of power over longer and longer distances.

At the beginning of this period of long-distance power development there was no past experience in high-voltage work upon which to base the designs of new lines of apparatus. Little was known of the characteristics of insulating materials and few materials which had proven satisfactory even for low voltages were available. Of the nature of the strains produced by lightning discharges, by switching, or by other static disturbances, nothing was known. Thus, the designer was forced to start upon the development of an entirely new class of apparatus, with no guide for his direction save his own good judgment. Under such conditions it is not to be wondered that mistakes were made, or that some trouble has been encountered with high-voltage apparatus, but rather that the number of such mistakes were so few and that the amount of trouble has been so small. The development of the transformer may be said to have progressed without interruption from the small and crude units of ten years ago to the large and highly perfected ones of today. One of the remarkable features of this development is the fact that on account of the rapidly increasing demand for units of larger size and higher voltage, it was not possible to wait for results which, under a more gradual development, would have been obtained from the actual operation of transformers

already manufactured; and so rapidly were designs and manufacturing methods changing that a transformer was often out of date before there was time for any inherent weakness to develop.

The state of the art of transformer manufacture has advanced to such a point that today the design of a 60,000-volt, 2,500 kw transformer is undertaken with a far greater assurance of success than was felt ten or twelve years ago in the design of a small 2,000-volt unit. An idea of this development may be obtained from the accompanying table, which is made up from the records of one of the largest electrical manufacturing companies. The transformers included in this list are all used for high-voltage transmission, and it is of interest to note that the 5,130 transformers represent an aggregate capacity of 1,059,838 kw—nearly 1,500,000 hp—the average size of unit being 210 kw.

*Output of High-Voltage Transformers Made by Westinghouse Electric & Manufacturing Company from 1892 to 1903, inclusive.*

Year.	No. of transformers.	Output kw.	Maximum voltage.	Maximum capacity kw.
1892.....	65	406	10,000	10
1893.....	19	272	3,000	19
1894.....	68	1,720	10,000	100
1895.....	78	4,215	10,000	200
1896.....	150	12,820	15,000	750
1897.....	165	21,091	30,000	850
1898.....	387	49,719	30,000	500
1899.....	662	119,492	33,000	1,875
1900.....	492	171,646	50,000	2,750
1901.....	997	201,475	50,000	1,000
1902.....	985	248,982	50,000	2,200
1903.....	971	228,000	60,000	2,500
Total.....	5,039	1,059,838	.....	.....

Transformers for long-distance transmission may be divided into two general classes: oil-insulated, and air-blast.

The oil-insulated transformers may be again divided into two general classes: self-cooling, and artificially cooled.

Practically all transformers are of the shell type of construction.

The working parts of the different classes of transformers are in

general similar, the principal difference being in the external case or housing. In all types the winding is made up of a number of thin flat coils, wound with a flat ribbon and with one turn per layer. These coils are assembled side by side and separated by insulating barriers and by spacing blocks, which permit a circulation of oil or air between them. The magnetic circuit is built up of laminations of specially selected and treated sheet steel. These laminations are securely held in place by end-frames surrounding the ends of the coils, and are held together by suitable bolts and braces. The case or housing is adapted for oil or air cooling as is required.

It has been found that in high-potential transformers there is, under certain conditions, an accumulation of the full line potential upon a few turns, so that for successful operation it becomes necessary to insulate the turns one from another in the most thorough and careful manner. The method of winding coils with one turn per layer affords an excellent means of accomplishing this result, as each turn can be insulated from every other one to any desired extent. A coil of this type has also comparatively few turns, so that a number of these coils are required for making up the total winding; thus the voltage on any one coil is reduced and the adjacent coils may be insulated from each other with insulating barriers of any desired thickness.

In order to keep down the reactance of the transformers, the primary and secondary coils are interlaced and, in general, the larger the transformer the more frequently are the coils interlaced.

In the construction of large transformers, the coils are very heavy, and in order that they may be thoroughly ventilated, it is necessary that their thickness be reduced to a minimum. Thus the problem of mechanically supporting them becomes a serious one, and in the design of such transformers the working out of the electrical design is a simple problem compared with that of designing proper methods for insulating and supporting the coils, so that they cannot become displaced or injured by electrical or mechanical forces. On certain large high-voltage transformers it is interesting to see the ingenious methods which have been worked out for mechanically supporting, for insulating and ventilating the windings.

The oil-insulated self-cooling transformer is wound for voltages as high as desired and for capacities as great as 500 kw. This transformer depends for its cooling upon radiation from the sur-

face of the case in which it is mounted. The only satisfactory case yet devised for a self-cooling transformer of large size is one made of heavy sheet iron, corrugated in such a manner as to give a very large exposed surface. The corrugated cases are mounted either in an angle-iron framework or with the sides set into a cast-iron base. A cast-iron top is usually provided and in this are placed suitable bushings for the primary and secondary leads. The self-cooling transformer has one great advantage over all other types, in that no extraneous devices are required for cooling, so that when once installed it will operate indefinitely with practically no attention.

The capacity of the self-cooling transformer is limited to approximately 500 kw. For greater capacities than this, the cost and dimensions of the case become excessive.

For many classes of service where no attention can be given to the apparatus, the self-cooling transformer is the only satisfactory type. This promises to be the case in single-phase railway work, where one or two transformers will be installed in out-of-way substations, or perhaps in certain cases on poles where inspection can be made at rare intervals only.

The oil-insulated artificially cooled transformer may be wound for any voltage and for any desired capacity. Its construction differs from that of the oil-insulated self-cooled transformer principally in the form of case and in the cooling devices. A number of different methods have been proposed and tried for carrying off the heat, but one method is now almost always used. This consists in forcing or siphoning water through coils of brass or copper tubing placed inside the transformer case below the surface of the oil. This method of cooling is the most simple and direct of any of the artificial cooling systems.

The case for containing the oil is usually made of boiler-plates riveted and caulked. A cast-iron case and cover are provided and the terminals of the water cooling coils and the leads from the primary and secondary windings are carried through this cover.

Another system of cooling, used to a limited extent, consists in drawing the hot oil away from the transformer tanks, circulating it through a cooling coil which is immersed in running water, and then returning the cooled oil to the transformer case. The circulation is maintained by means of a small motor-driven pump. The advantage of this system over the first one mentioned is that in case of a leak in the cooling system the oil will escape into the water



instead of the water into the oil; but as there are very few cases on record where trouble has resulted from leaky water-coils, this advantage does not seem to be of great moment. To offset this single advantage, a pump, a motor, a cooling tank and a system of oil piping are required for the cooling system, and there is the possibility that should a deposit form in the oil it will gather on the inside of the tubes and prevent the circulation and cooling of the oil.

The air-blast transformer, as its name implies, is one in which the cooling is accomplished by means of a forced draught of air. It may be wound for pressures not exceeding approximately 33,000 volts, in units of any desired capacity.

The transformer proper is mounted in a cast-iron housing, so arranged that air, which is admitted at the base, may pass through the cooling ducts between the coils and through those in the iron. Two separate air-passages are provided, one for cooling the coils and the other for cooling the iron. Dampers are arranged for controlling the air in either passage. The transformers are usually placed above an air-chamber in which a pressure usually less than one ounce per square inch, above the surrounding air, is maintained. The air is supplied from large steel-plate fans, which are usually directly connected to induction motors. The power required for cooling is small, being usually one-tenth to one-fourth of one per cent of the transformer capacity.

On account of the difficulty of eliminating static discharges over the surfaces of the coils of the air-blast transformer, it has been found impractical to use this type of construction for pressures exceeding approximately 33,000 volts, and the greatest success has been obtained at voltages not exceeding 20,000.

During the past year, a considerable amount of discussion has occurred regarding the relative fire risks of oil-insulated and air-blast transformers. The general results brought out seem to indicate that so far as actual damage to the transformer itself is concerned, either by internal or external heat, the risk is much greater with the air-blast transformer than with the oil-insulated type. This greater risk of the air-blast transformer results, not only from the more inflammable nature of its insulation, but also on account of the presence of the air blast, which tends to increase the rate of combustion, as well as by the open construction necessitated by the method of cooling.

In the oil-insulated transformer, the oil cannot be ignited unless

it is first raised to a very high temperature. Oil also acts as an extinguisher of arcs which occur below its surface, and, if the transformer is inclosed in a tight case, the oil, even if ignited, cannot continue to burn, on account of lack of fresh air.

There is, however, a danger incident to the operation of the oil-insulated transformer which is due to the fact that oil-vapor, when mixed with the proper proportion of air, forms an explosive mixture, which, becoming ignited, may burst the containing case and permit the oil to escape. With large transformers it is now customary to use a practically air-tight case, sufficiently strong to withstand an internal pressure of approximately 100 pounds per square inch, which is probably in excess of any pressure that can actually be obtained. In large transformer installations, each transformer, or each group of transformers, is often placed in a vault or pit, which is properly drained and, in event of a case being damaged by external causes so that oil escapes, it will not spread about the station floor, but be carried away by the drain.

With every precaution taken, the presence of large quantities of oil must constitute a certain fire risk, and for this reason it has become the general practice to specify air-blast transformers for use in sub-stations which are located in thickly populated portions of large cities. Such transformers are usually wound for 6,000 to 15,000 volts, for which pressures the air blast transformer is well adapted. For very high voltages, it is of course necessary to use oil-insulated transformers, taking such precautions in their installation, as to reduce to a minimum the danger to surrounding buildings or apparatus.

A method for reducing the fire hazard of the oil-insulated transformer which has been used to a limited extent, consists in placing the transformer in a tight case with a vent-pipe connected to the top of the dome-shaped cover. At the bottom of the case a connection is made with the water-mains, so that, in case of necessity, water can be admitted at the bottom of the case, driving out the oil through the top vent and leaving the case filled with water. The vent may be connected with a sewer, or with a suitable tank for receiving the oil.

A mineral oil is used in transformers. It should have a fire-test of not less than 200 deg. C.; its evaporation at normal running temperatures should be negligible; it should be free from acids, alkalis, water or sulphur compounds, and should show no deposit at the maximum operating temperature of the transformer.

In Europe, the three-phase transformer has been very extensively used. In America it has not come into general use. This is doubtless due to the fact that single-phase transformers present a much more flexible arrangement than one three-phase unit, while there is but a slight difference in cost in favor of the three-phase unit.

For transmission voltages not exceeding 33,000 volts, it is customary to connect both high-tension and low-tension windings of transformers in delta, as with this arrangement two transformers will continue to deliver three-phase currents even though one transformer be disabled. For higher voltages, transformers are frequently connected with low-tension windings in delta and high-tension windings in star. This permits the grounding of the neutral point of the system, limiting the voltage between any wire and ground to 58 per cent of the line voltage. The winding and insulating of the transformer is also somewhat facilitated, on account

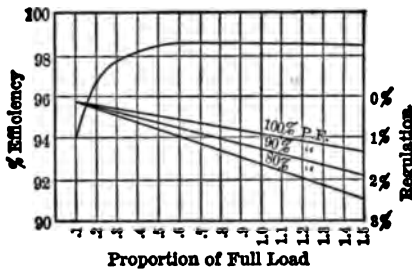

FIG. 1. EFFICIENCY AND REGULATION CURVES, 2200-K. W., 50,000 VOLT, 25-CYCLE TRANSFORMER.

of the lower voltage of the star-connection. The star-connection, on both high-tension and low-tension windings, is apt to prove an unstable arrangement, as, under certain conditions, it permits the full line voltage to be concentrated upon two of the transformers. In general this connection should not be used.

The efficiency and regulation obtained on transformers is probably superior to that of any other apparatus in the transmission system. On large units, even though wound for low frequency and high voltage, efficiencies of 98.5 per cent may be obtained. Fig. 1 shows an efficiency curve of a 2220 kw transformer, for a frequency of 30 cycles, 50,000 to 1100 volts. It should be noted that the efficiency is practically constant at 98.5 per cent from three-quar-

ters to one and one-half load. The remarkably close regulation of this transformer even with loads of low power-factor should be noted also.

From the records of one of the large manufacturing companies, certain data has been obtained regarding the capacities, voltages, and output of high-voltage transformers during the past ten or twelve years. These results have been prepared in graphic form, and appear in Figs. 2, 3 and 4. These curves give a fair idea of the progress in the state of the art of high-voltage transformer

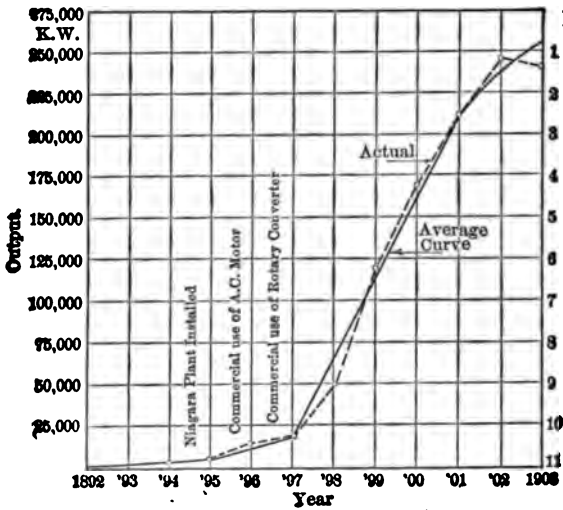

FIG. 2. OUTPUT OF HIGH-VOLTAGE TRANSFORMERS, 1892 TO 1904.

building. Fig. 2 shows the output of high-voltage transformers for different years. It seems almost incredible that in ten years' time the output per year should have increased from 300 or 400 kw to 250,000 kw. Upon this curve the effect of the installation of the Niagara plant, as well as the introduction of the alternating-current motor and the converter, may be clearly seen. The effect of the recent financial depression is also shown in a decreased output for 1903 over that of 1902.

Fig. 3 shows the maximum size of unit manufactured during the different years, also the average size of unit for the different years. In eight years time, the maximum unit increased from 10 kw to 2750 kw—275 times—while the increase in the average

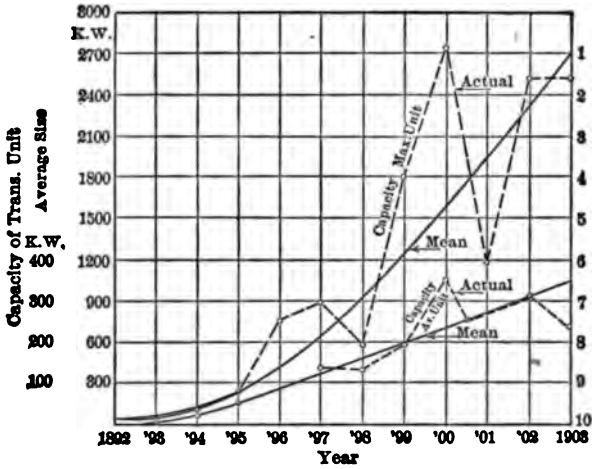

FIG. 3. MAXIMUM AND AVERAGE CAPACITY OF TRANSFORMER UNITS FOR DIFFERENT YEARS.

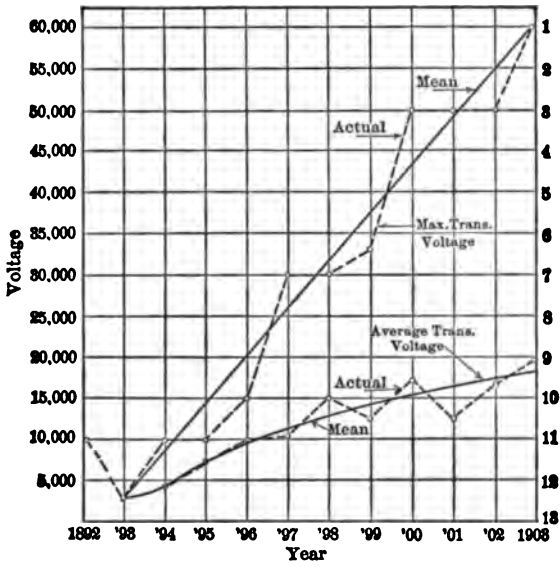

FIG. 4. MAXIMUM AND AVERAGE TRANSFORMER VOLTAGES, 1892 TO 1904.

size of unit has been from 10 kw to 250 kw—an increase of 25 times.

Fig. 4 shows the maximum voltage for which a commercial transformer was wound during the different years, also the average voltage during the different years. It will be noted that the increase has been from 10,000 to 60,000 volts, not nearly so great an increase as that in size, but one which represents far greater difficulties to the transformer manufacturer. The average pressure seems to be growing constant at approximately 15,000 volts. This is due doubtless to the fact that a very large number of the transformers sold are for use in large cities on 10,000-volt service for supplying converters for railway or lighting service.

#### DISCUSSION.

Chairman SCOTT: The one thing which has given prominence to the alternating current and which has made possible the present types of power transmission and the use of high voltages is the transformer—a piece of apparatus most simple in itself. The component parts are most elementary in kind and for demonstration purposes very simple elements will suffice. But the transformer for use has undergone a very great development and many of the points to which Mr. Peck has referred are the points of engineering development of the transformer. In a certain way the lines of development have not departed from the earliest types. The type of transformer used in the first 10,000-volt transmission in this country, is, in its essential particulars, the same as the transformer used to-day. The details, the form of iron plate, the shape of coils, and the number of coils has changed in the development of the larger transformer. The oil insulation is the same. What we have done is to develop one type. It will be valuable in the discussion of this subject to have any comments upon the immediate points taken up in the paper and the particular usefulness of the various types. It would also be serviceable to have any suggestions on departures from this type. Are we in future to keep along the same line? Will the transformers of ten years hence be essentially those of to-day or will they be along radically different lines? The paper is open for discussion.

Mr. FRANCIS O. BLACKWELL: I cannot agree with Mr. Peck regarding there being practically no fire risk with oil transformers. In large stations the transformer cases contain hundreds of barrels of oil. It is true that, in most cases of power-houses being destroyed by fire, the evidence indicates that the fire originated in combustible material in the neighborhood of the transformer and not in the transformer itself. The oil leakage from the transformer, which cannot be entirely prevented, is a source of danger. If a fire starts near the transformer and heats it up sufficiently, it will turn it into a gas producer and sufficient gas can be turned out to melt up all the iron work and machinery in any power-house. I think

that, when you install such a large body of oil in a building, you would at least take the same precautions against fire that you would had you one or two barrels of illuminating or lubricating oil in a factory. The insurance rules would require you to place such oil in a separate fire-proof room. In power-houses and sub-stations, which I have recently designed, each transformer is enclosed in an airtight fireproof compartment. These compartments prevent the accumulation of combustible material in the neighborhood of the transformer, and, further, should a fire start, it will smother itself out as soon as the oxygen in the room is consumed.

There is another matter in connection with Mr. Peck's paper to which I would like to call attention and that is—the relation of efficiency to cost. A transformer designed for, say, 98 per cent efficiency, will cost nearly twice as much as one with 96 per cent efficiency. Expressed in another way—if you cut your losses in two you must use twice as much material in the construction of the transformer. It is an open question, therefore, as to how high in efficiency it is economical to go. The interest on the cost of the transformer might readily be more than the value of the power saved.

Mr. E. KILBURN SCOTT: We, in England, were using oil at a very early date; but our experience was unfortunate and its use was dropped altogether. We were surprised to hear some time afterward that oil was proving a success in America. Any oil which we now use for the purpose is obtained from the States, and if the author of the paper would say something about the way in which this oil is prepared, it would be appreciated. American makers treat it in some way that our manufacturers apparently do not know about; at any rate, we cannot get suitable oil in England.

Regarding the cooling by air, it has occurred to me that probably air under considerable pressure might be used for the transformer which will have to be installed for working main-line railways by alternating currents. I do not know whether you have noticed how when coalcutting machines are worked with compressed air, snow forms on the pipes and valves, owing to the sudden expansion of the air when it leaves the exhaust. This is a common occurrence in machinery driven by compressed air. Now I think that probably the transformers on railways could be cooled by having compressing stations at various points, to effect the cooling by this sudden expansion of air.

Coming to the question of the containing case, I notice many transformer cases are carefully ribbed outside, but are left smooth inside. This is probably done for ease in making the casting; but I think it would pay to incur a little more expense, and rib the inside of the cases as well. In fact, I think corrugated iron sheeting closed up (that is to say the pitch of the corrugations reduced from the usual three inches to say one inch) would be very effective, as it would give a large inside cooling surface, as well as a large outside cooling surface. We do not want great thick castings. To make a casting, say, six feet high, the bottom will have to be  $1\frac{1}{2}$  inches thick; because the moulder cannot very well get it thinner. The sides will, therefore, vary from  $1\frac{1}{2}$  inches to  $\frac{1}{2}$  inch, or so, at the top

and this is very thick metal through which to expect the heat to travel. I think the walls should be made of thin corrugated steel, as it would not only give ample cooling surface, but also great strength.

Speaking of the air-blast for cooling, it may be of interest to mention that the first Thomson electric welding plant shown at the Glasgow Exhibition about 1888, was bought by Clarke, Chapman & Co., and employed by them for welding connecting rods, etc., for ship's winches. They tried to use it for larger work and had several burn outs. On their asking my advice, I suggested turning the blast from the Smith's hearths through the electrical apparatus and this was done. It was probably one of the first examples of air-blast cooling of electrical apparatus.

Dr. LOUIS BELL: With respect to these large oil-cooled transformers, I think we all appreciate the danger to which Mr. Blackwell has alluded — that is, the fire danger; but perhaps we do not all appreciate at once the troubles which complete isolation of transformers invites. For example, you can undoubtedly box up a transformer or any other piece of apparatus so that a fire originating in it or communicating to it cannot possibly find its way out of the space in which it is placed, but in doing that you necessarily sacrifice a good deal of simplicity. I think the tendency in modern practice, the practice of the next few years, is going to be greatly in the direction of simplification of stations, simplification of all the connections possible, and the abolition of a great deal of accessory equipment and apparatus which now forms a very formidable feature of the cost and maintenance of many large stations. To that end I think that the direction in which our energies should be spent is toward keeping fire away from transformers rather than making too elaborate provisions for confining it to them after it gets in. It is better to lock the door before the horse is stolen. And it seems to me that a proper oil transformer runs very little risk, according to my experience, of getting on fire from the inside. As Mr. Blackwell very justly remarked, the danger is on the outside. And if you keep combustible materials away from your transformers, just as you would keep it away from any other place, the whole plant is much simplified. The danger at stations, according to the observation of a good many of us, I think, is in about the last place where one would at first suppose, that is to say, in the floor. You can design a fire-proof wall, you can design a fire-proof roof — fire-proof in any ordinary sense of the term, but to get an adequate floor on a station is a more serious problem. Concrete floors, you know, if well soaked from leakage of lubricants or anything of that kind, will furnish a very respectable furnace. I know one large factory in the East that was totally destroyed; the interior of it became a furnace on account of a floor which was supposed to be fire-proof but was charged with oil. I think if you pay attention to the station and keep combustibles away as far as possible from the outside of the transformers and their connections, including cables, that the danger of fire will be very much reduced. As it is now, I have, time and again, been in stations with first-class dynamo equipment, with the best modern transformers, and with some foolish collection of accessories arranged so as to catch any flames that might come



therefrom. This is particularly true of the switchboard as found in many power-transmission stations. Time and again I have seen a switchboard which was simply a fire trap, with a great mass of insulated wires and other stuff which will burn at high temperatures, snugly tucked away behind it, in the interest of compactness, with the result that if anything went wrong on that board you would have a little furnace started, capable of heating things even to the point of ignition of oil in the vicinity. I think that in the safety of transformers and other apparatus, the floor at the station is a matter that is too often neglected. As regards air-blast transformers, they are not faultless as a fire risk. I have seen a transformer, which was supposed to have gone out, burn on all night, scattering around cinders liberally. It seems to me that our work should be largely in the line of the prevention of the communication of any fire to the station or the spreading of any fire which may originate from a short-circuit. If you do not crowd the place too much; if you do not attempt to build a station too compact—and most power-transmission stations are in places where compactness is not necessary—you can avoid a great many of these dangers. It is very pretty to go into a station and say "Here is our beautiful, compact switchboard; here are our accessories of various kinds; you see there isn't an inch of waste space." Well, waste space is sometimes the very best insurance that we can have, particularly in fire risks.

Dr. F. A. C. PERRINE: I think we should not allow to pass, without correction, an apparent error in observation that Mr. Kilburn Scott has made on his American tour in regard to the self-cooled transformers, as we call them. There are four types in this country: We have the boiler-iron case, smooth inside and out; we have a corrugated sheet-iron case which is corrugated inside and out; we have a corrugated cast-iron case which is corrugated inside and out; and the fourth, which is the only one which corresponds to his description, is a boiler-iron case with external or iron radiating strips. So far as I know, there are not made in this country any cases of cast-iron with external radiating strips and smooth internal surface. A majority of the large self-cooled transformers made in this country are made either with corrugated sheet-iron cases, corrugated inside and out, or corrugated cast-iron cases, corrugated inside and out. So that the suggestion that he makes of radiating strips passing within the oil, as well as outside into the air, is actually our practice.

Mr. J. S. PECK: At one time the Westinghouse Company made a case which was smooth inside. First we had it ribbed inside and outside, then we found that the ribs inside did no good so we cut them off and left the ribs outside. Now I think the explanation of this was, that for heat to get from the oil into the cast iron is a comparatively simple matter. The whole trouble comes in getting the heat from the cast iron into the surrounding air, and I don't think—in fact I am very sure—that it would not do any good to put ribs inside.

Dr. PERRINE: Are any such transformers being manufactured now?

Mr. PECK: As far as I know there are none.

Mr. W. L. WATERS: I think Mr. Blackwell called attention to an important fact when he pointed out that the cost of a transformer depends

upon its efficiency. Apart from this question of efficiency, the rating of a transformer is simply a question of getting rid of the heat developed without damaging the insulation. And therein lies the advantage of a water-cooled transformer, as in this type you can carry away a considerably larger amount of heat by increasing your circulation of water. So that you can make a much cheaper transformer if you sacrifice efficiency, and increase the circulation of your water in this type of transformer.

In regard to the point that Mr. Kilburn Scott brought up about the quality of oil, I think that the only way you can rely on that is to purify, or bring the oil up to standard, yourself. We had considerable trouble lately with a large shipment of transformers which was held up on account of the quality of the oil received from the Vacuum Oil Company. Apparently the oil may be all right when it leaves the refinery, but it may not be all right by the time it is put into the transformer. The only thing you can do, is to dry the oil and filter it yourself, and repeat the process until it stands a definite sparking test.

Mr. E. KILBURN SCOTT: Do you use resin oil?

Mr. WATERS: No; it is ordinary mineral oil, petroleum oil.

Mr. E. KILBURN SCOTT: The stuff we use is resin.

Mr. WATERS: I never heard of resin oil being used. I think Mr. Peck is perfectly correct in what he says about the ribs on the inside of a transformer casing. If you take the temperature of the oil and the temperature of the case and the air you will see that the drop of temperature is almost entirely at the surface of the iron and air, and there is only a very small drop, may be 5 degrees, between the oil and the case, so that whether you have internal ribs or not doesn't really make much difference. And it is well recognized that when a body is cooling in contact with a fluid, the drop of heat potential across the surface, that is, the heat contact resistance, is much less in the case where this fluid is a liquid than in the case where it is a gas. It would only be a waste of space and material to put ribs on the inside, as well as on the outside, of a transformer casing.

Prof. F. G. BAUM: I would like to make a short statement to answer numerous questions that have come to us on our system regarding the fire at Colgate two years ago, and also to answer Mr. Blackwell in regard to a question of the relative fire risk of the two types of transformers. In Colgate we had the transformers in the power-house, setting under a gallery constructed mainly of wood, the main frame being of iron, the smaller working being of wood. The fire started owing to an imperfect, badly designed, oil-switch and not, as generally given out, due to any trouble in the transformer. The fire raged fiercely, so fiercely that it bent the iron in the roofs, bent the eye-beams on the gallery, warped the iron out of shape, yet did not injure a single transformer except that in one transformer two of the layers of the wraps had to be removed and re-taped. The oil in only one transformer caught fire; the oil burned down in it about half way and stopped. The fire raged through a length of 150 feet. There were something like 25 transformers in the building, each of which had about four barrels of oil. And I think that experience demonstrates the extent of the fire risk of oil-type transformers.

Mr. F. O. BLACKWELL: In regard to the insulating value of trans-

former oil as effected by moisture, we recently had an experience with a number of large transformers wound for 60,000 volts. When these were set up at the works of the manufacturer they stood all tests successfully, but after they had been installed and put in actual service it was found that the high potential current arced through the oil to the low potential coil and to ground. Moisture in the oil could not be detected by chemical analysis, but by placing a small quantity in a bottle filled with chloride of lime it was found that the insulating resistance could be raised to its proper value. All of the oil was finally treated by forcing hot air through it until the whole body of the oil was raised above the flashing point which dried it out and brought it back to its original dielectric strength. An investigation as to why the oil had deteriorated so much developed the fact that the barrels in which it was shipped had not been thoroughly dried and cleaned before they were filled.

Chairman SCOTT: If there is no further general discussion we will ask Mr. Peck to close the discussion, because time is becoming short.

Mr. PECK: I agree in general with what Mr. Blackwell said about the risk of oil-insulated transformers. The risk comes not from internal damage to the transformer itself but damages which may be done to external apparatus by the escape of the oil, and if it can be put into tight cases or tight vaults or, as is being done in some cases, put in tight cases and then put in vaults, not tight, but built up perhaps half the height of the transformer—pits, in other words,—and these are thorough drained, I think any of those precautions will go a long way to eliminate the fire risk. As to the oil, a mineral oil is used and it is bought under very strict specifications; it must be free from acids, alkalis, or sulphur compounds, and free from water. Great care must be taken to prevent oil from absorbing moisture or other impurities during the time of transit—from the time that it leaves the manufacturer until it is placed in the transformer cases. As to the thickness of castings, of course it is an advantage as far as the dissipation of heat is concerned to have the castings or have the metal as thin as possible, although I do not think that the drop in heat potential through the metal is ordinarily of great importance. Those castings are usually made as thin as they can be made and cast. That is the determining factor.

Mr. E. KILBURN SCOTT: Do you think that the oil in transit could absorb moisture if it happened to get in a damp situation, after being thoroughly dried out?

Mr. PECK: I think there is no doubt that it would.



## NOTES ON EXPERIMENTS WITH TRANSFORMERS FOR VERY HIGH POTENTIALS.

---

BY PROF. HAROLD B. SMITH, *Worcester Polytechnic Institute.*

---

The attention of the writer was first directed toward the problems involved in the production and application of high potentials of low frequency by certain of the exhibits at the Chicago Exposition of 1893, and particularly by the discussion before the International Electrical Congress of 1893 on power transmission.<sup>1</sup>

As a result of this interest, during the college year 1893-94, in connection with the direction of the School of Electrical Engineering at Purdue University, two senior students<sup>2</sup> at the University designed and constructed, under the writer's supervision, a small transformer to give an effective secondary potential of 10,000 volts.

This transformer was constructed with but slight knowledge of the difficulties involved and was a failure except for the many valuable lessons received from successive attempts to operate it under the proposed conditions.<sup>3</sup> The following year this transformer was reconstructed by two senior students at the University<sup>4</sup> and was operated for some time before a final break-down occurred, but there could be no hope for the final success of such a transformer.

Following a suggestion by Tesla in a paper before the Institution of Electrical Engineers,<sup>5</sup> paraffin oil was heated, and by means of an air-pump drawn into a closed metal-lined box containing the core and windings. The oil apparently penetrated to all the surfaces of the core and windings, and it is probable that, so far as this part of the work is concerned, good results were secured; but un-

1. *Proceedings of the International Electrical Congress, 1893*, pp. 422-472.

2. G. G. Phillips and S. Moore, Thesis, "The Design and Construction of a High Voltage Transformer." Purdue University, 1894.

3. Primary, 1000 volts; secondary 10,000 volts; frequency 140. Primary had 248 turns. No. 14 B & S, and secondary 2840 turns No. 22 B & S. Core made of No. 16 iron wire.

4. Messrs. A. C. Bunker and C. C. Chappelle.

5. *Journal of the Institution of Electrical Engineers*, Vol. 21, p. 79.

fortunately rubber insulation was used on the secondary winding and this was promptly softened by the oil.

While this transformer was a failure in all respects, except that it led to success with later transformers, no responsibility for this failure should rest upon the four young men who assisted in its design and construction, as the writer was responsible for the important features of the design and the failure should be assumed by him alone.

On account of the pressure of many duties and the interruption of this work occasioned by the acceptance of the chair of Electrical Engineering at the Worcester Polytechnic Institute in 1896, this work was not continued until the college year 1897-98, when two graduate students<sup>6</sup> in electrical engineering at the Institute, under the writer's direction, undertook the design and construction of a 150,000-volt transformer, which was completed early in the spring of 1898. The experiences with the transformer of 1894, the succeeding interval of four years for occasional study of the various causes of its failure, together with many valuable suggestions from Prof. J. O. Phelon of the Worcester Polytechnic Institute and the remarkably able manner in which the two men who were engaged upon this work carried out the details of the design and construction, account for the thorough success of this second transformer.

A reference to this transformer, which had a ratio of voltages of 1 to 1500, and an illustration showing its construction appear in the *Transactions* of the American Institute of Electrical Engineers<sup>7</sup> in a note communicated by the writer to the discussion of the paper by Steinmetz on the "Dielectric Strength of Air."<sup>8</sup> More detailed descriptions of this transformer appear elsewhere<sup>9</sup> so that no extended description need be given here. However, a statement of experience with this transformer for the past six years may have some interest and value.

For several years the transformer was in fairly constant experimental service in the laboratories of the Institute on work<sup>10</sup> which

6. Ellery B. Paine and Harry E. Gough, Thesis, "High-Potential Discharges in Dielectrics." Worcester Polytechnic Institute, 1898.

7. *Transactions American Institute of Electrical Engineers*, Vol. 15, p. 328.

8. *Ibid*, p. 281.

9. *Journal of the Worcester Polytechnic Institute*, Vol. 1, p. 356; *Electrical World*, Vol. 32, p. 63.

10. S. S. Edmands and W. E. Foster, Thesis, "Distribution of Potentials Between High-Potential Conductors." C. E. Eveleth and E. F. Gould, Thesis, "Dielectric Strength of Oils." O. P. Tyler and S. T. Willis,

THE UNIVERSITY OF CHICAGO  
LIBRARY  
540 EAST 57TH STREET  
CHICAGO, ILL. 60637

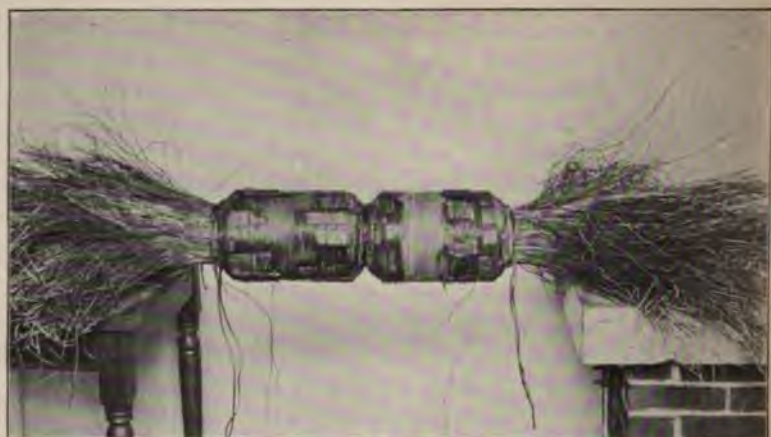

FIG. 1.— 10,000-VOLT TRANSFORMER, 1893.

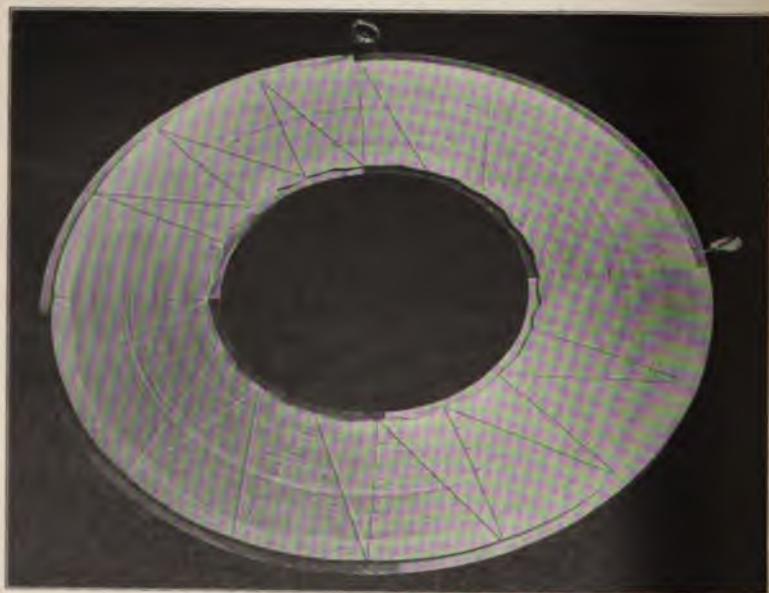

FIG. 2.— COIL OF 200,000-VOLT TRANSFORMER, 1904.



involved operation at potentials as high as 190,000 effective volts and for many days was operated for 10 hours per day at 175,000 effective volts. Nearly a year ago, this transformer was sold to be used for commercial testing by a company manufacturing insulators and information has been received recently of its continued satisfactory daily service at potentials ranging up to its rated capacity.

This transformer was exhibited at the Saratoga (1903) Convention of the American Street Railway Association, and at this time several coils of the secondary winding were injured in shipment and had to be replaced; with this exception, practically no difficulty has ever been experienced in its operation. It was designed primarily for experimental work in the laboratories of the Worcester Polytechnic Institute and many details of construction would naturally be changed in a design intended for commercial service, although the general features of the design have demonstrated their reliability for this class of work.

In the fall of 1899, two seniors<sup>11</sup> in electrical engineering at the Institute undertook the development of a transformer for still higher potentials and in the spring of 1900 produced, under the direction of the writer, a transformer designed for a secondary potential of 330,000 volts at 60 cycles per second; but under test, this transformer failed to develop potentials higher than 210,000 effective volts at the terminals of the secondary circuit.

Failure to operate this transformer at higher potentials may be attributed, in part, to an absence of knowledge at the time of its design, of phenomena which occur at the higher potentials and which had not been observed in the operation of the 1898 transformer below 175,000 volts. In part, the failure of this transformer may also be attributed to defects introduced by frail construction and faulty design of the windings, as the transformer was regarded as a purely experimental affair, and expensive construction

Thesis, "High-Potential Tests of Solid Dielectrics." E. H. Ginn and W. J. Quinn, Thesis, "Surface Leakage on High-Potential Insulators." J. M. Bryant, Thesis, "The Commercial Production of Ozone." A. L. Cook, A. P. Davis and J. B. Wiard, Thesis, "Leakage Losses on High-Potential Transmission Lines." W. M. Adams and W. H. Sigourney, Thesis, "Surface Leakage on High-Potential Insulating Materials." H. W. Morehouse and E. L. Stone, Thesis, "The Distribution of Potentials Between High-Potential Conductors."

11. H. I. Cross and S. E. Whalley, Thesis, "The Design, Construction and Test of a High-Potential Transformer." Worcester Polytechnic Institute, 1900.

was avoided whenever possible and in too great a measure for satisfactory results. However, as in the case of the 1894 transformer, failure to accomplish the results anticipated led to a closer study of the phenomena involved in this class of work, and to success later in the production of a transformer for even higher potentials.

During the college year 1900-01, four graduate students<sup>12</sup> in electrical engineering at the Institute undertook the design and construction of a 500,000-volt transformer at the suggestion and under the direction of the writer. This transformer was in operation early in May, 1901, and at that time developed a secondary potential, at 60 cycles per second, which was capable of disrupting a 48-in. (1.22 meter) air-gap between sharp needle points.

As this is undoubtedly the first transformer and, so far as the writer is informed, the only transformer which, up to the present time, has, with a *single transformation* or even with several transformations by a number of transformers, secured low-frequency potentials in the neighborhood of one-half million effective or three-quarters of a million maximum volts, a brief description may be of value.

The design of this transformer called for a ratio of transformation of 1 to 2520, at 60 cycles, and a maximum core density of 8600 gaussess, when at a secondary potential of 500,000 effective volts. The primary winding consisted of 46 turns of heavy stranded conductor—23 turns on each core—in series for a primary potential of 200 volts, 60 cycles, giving a maximum magnetic flux of about 1,600,000 maxwells at full rated voltage. The secondary winding was subdivided into 66 coils, each of which was further subdivided by cotton tape into four sections. There was a total of 115,920 turns of number 32 B & S double cotton-covered wire in the secondary winding. Each coil was wound in a spool turned from thoroughly seasoned white pine of the very best quality and carefully selected stock. The cross-section of the spool is shown in Fig. 5, and the outside diameters of the spools ranged regularly from 16 ins. up to 32 ins.

The middle of the secondary winding was connected to the core and to the primary winding, and carefully earthed in most of the work which has been done with this transformer, although it has

12. R. S. Beers, F. R. Davis, E. H. Ginn, W. J. Quinn, Thesis, "The Design, Construction and Test of a 500,000-Volt Transformer." Worcester Polytechnic Institute, 1901.

1942  
MAY 20 1942  
COMMUNICATIONS  
SECTION

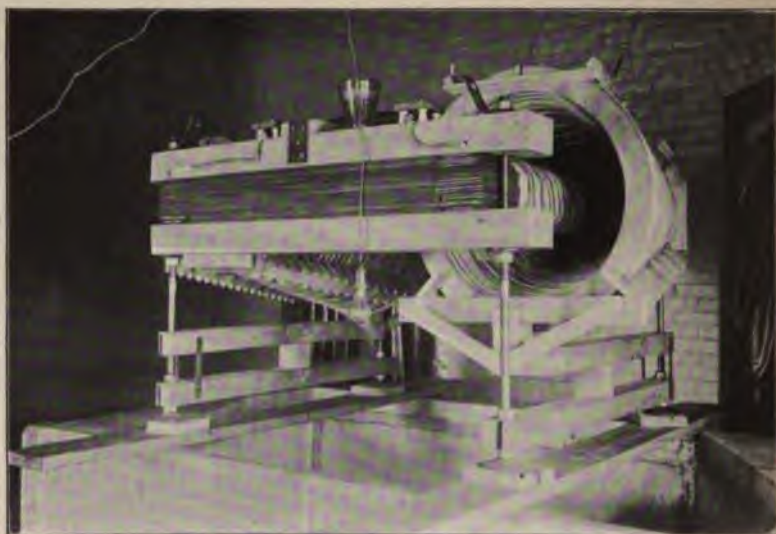

FIG. 4.— 500,000-VOLT TRANSFORMER, 1901.



FIG. 6.— HIGH-POTENTIAL LABORATORY, WORCESTER POLYTECHNIC INSTITUTE.

been operated on a number of occasions without earthing the secondary circuit. The primary circuit, supplied with current from a generator which may be regulated as desired, was always earthed for the protection of the operator.

This transformer has been used for three years upon work of investigation connected with various thesis subjects<sup>13</sup> upon which students at the Institute have been engaged, together with some work carried out personally by the writer upon the dielectric properties of air and oils. During this time, it has been found necessary upon two or three occasions to cut out a few faulty coils of the secondary winding; but when it is stated that this winding contains about 125 miles (about 200 km) of No. 32 B & S wire which was not wound in layers, although each coil may develop from 8000 to 9000 volts, this is not surprising. Tests made with this transformer indicate that, with the substitution of a modification of the secondary winding which has been introduced by the writer in transformers of more recent design, a potential of not less than 750,000 volts effective, or over a million volts maximum, can be secured from this transformer. As soon as suitable opportunity presents itself, it is proposed to make this change. The transformer is located in a separate transformer-house on the campus of the Institute, at some distance from other buildings on account of the fire risk occasioned by over a thousand gallons (3800 litres) of oil required for insulating the secondary winding.

On May 27 of this year, an order was placed with the writer for a 200-kw, 300,000-volt transformer which was shipped to its destination July 18, and has recently been placed in operation and accepted by the purchaser.<sup>14</sup> As this transformer was designed along lines which will permit its operation at considerably more than its rated voltage and power output and probably constitutes the largest transformer yet built for very high potentials, the writer has been permitted to give the following brief description:

Fig. 7 shows an assembled view of the transformer core and secondary winding ready to be immersed in the oil contained in the transformer tank. The connections to the primary and secondary

13. R. S. Beers, F. R. Davis, E. H. Ginn, W. J. Quinn, Thesis, "Investigation of the Dielectric Strength of Air and Oils." L. Day and C. F. Harding, Thesis, "Investigation of the Leakage Loss Between High-Potential Transmission Conductors." A. L. Cook, A. P. Davis, G. E. Munroe, E. W. Kimball, J. A. Sandford, Thesis, "Investigation of the Leakage Loss Between High-Potential Conductors."

14. The Locke Insulator Mfg. Co., Victor, N. Y.

circuits are so arranged as to permit full rated power output at secondary potentials of either 75,000, 150,000 or 300,000 volts, 60 cycles. The maximum ratio of primary and secondary turns is 316, as the primary is designed to be supplied from a 1040-volt generator. The secondary contains about 33,000 turns of about 42 miles (about 68 km) length of conductor.

On Aug. 15, work was begun upon two transformers which are not yet finished, but of which some information can be given. Fig. 2 shows one coil of the secondary winding, which contains 280 turns of double cotton-covered wire having a section of copper of .004 in. x .05 in.

These transformers have been given a preliminary rating of 200,000 volts, but have been designed along lines which should

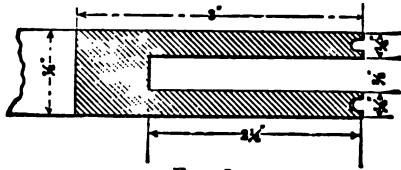

FIG. 5.

permit of their operation at potentials considerably above this value.

One of the transformers is provided with a removable yoke so as to permit of its experimental use as an induction coil of large output, when so desired, and both transformers have been provided with extra leads so as to permit of a variety of combinations for experimental work at the Institute on single, two and three-phase circuits of very high potential. One hundred coils, such as the one shown in Fig. 2, will constitute the secondary winding of each of these transformers, so that each secondary will have a length of about 25 miles (about 40 km) of wire.

PUBLISHED BY  
THE  
ASSOCIATION  
OF  
TELEPHONE  
EXCHANGES

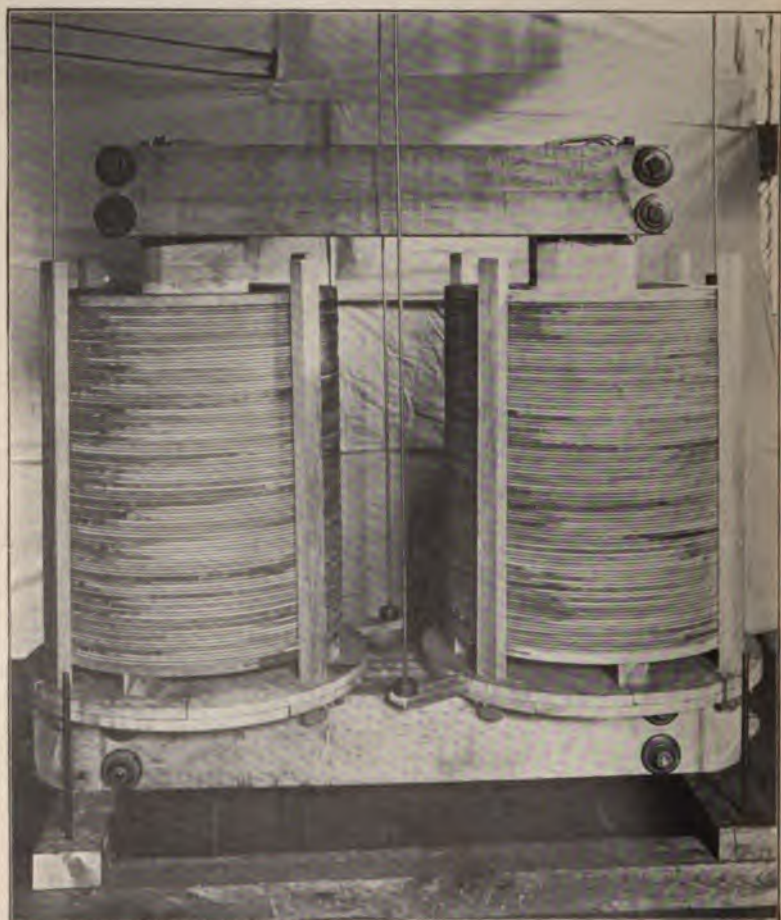

FIG. 7.—SIDE VIEW OF 200 KW, 300,000-VOLT TRANSFORMER, 1904.



# HIGH POTENTIAL, LONG DISTANCE TRANSMISSION AND CONTROL.

---

BY F. G. BAUM.

---

## INTRODUCTORY.

In 1900, at the General Meeting of the American Institute of Electrical Engineers, I presented a paper entitled "Some Constants for Transmission Lines," based on measurements made on several transmission lines — the longest that had been built up to that time. Since then I have followed very closely the progress of transmission work, and in this paper I will give the practice and results on what is, and has been since 1900, the greatest transmission system in existence.

The system to which I refer is that of the California Gas & Electric Corporation, which has absorbed the Bay Counties Power Company, the Standard Electric Company of California, the Valley Counties Power Company, the Sacramento Electric, Gas & Railway Company, the Yuba Electric Power Company and the Nevada County Electric Power Company. The accompanying map will give some idea of the system.

The system has continuously in operation about 700 miles of line at 50,000 volts, 70 miles at 40,000 and a great many miles at 23,000, 16,000, 10,000 and 5,000 volts. The high-voltage lines extend from the Sierra Nevada Mountains of California to the Bay of San Francisco, and are thus exposed to all sorts and conditions of weather. In a short time some of these lines will be operating at 60,000 volts. The longest distance to which power is regularly transmitted is 200 miles, most of the power being transmitted 150 miles. The amount of power available on the system is 43,650 kw, and this will soon be increased by the addition of two 5000-kw generators at Electra. Owing to the large day motor load the peak on the system is not above 25 per cent of the average load.

In this paper I will give as briefly as possible some simple

**BAUM: LONG DISTANCE TRANSMISSION.**



**MAP OF HIGH-TENSION TRANSMISSION LINES OF CALIFORNIA GAS & ELECTRIC COMPANY. LINE FROM COLGATE TO OAKLAND IS IN DUPLICATE.**

methods of line calculation, and deal with the means of controlling the power at the high voltages.

### PART I. LINE CALCULATIONS.

The theory of the transmission of electrical energy over commercial distances is quite simple, and at present better understood than formerly, but there is still more guess work than there should be. As all long transmission work is three-phase, this is the only system which need be considered.

1. *Circuits.*—In making three-phase line calculations, it is generally simplest to consider one leg of the system, assuming it to have neutral return with no resistance or reactance. Generally, high voltage systems are operated with grounded neutral, but whether the neutral is grounded or not we may consider the quantities between one line wire and a real or assumed neutral. The wires will be assumed as arranged on the corners of a triangle.

2. *Charging or Capacity Current.*—In the paper referred to above, I showed that the line capacity of a three-phase line is star connected, the capacity of each wire to neutral being given by the equation —

$$C = \frac{1}{2 \log_e \left( \frac{d}{r} \right)}$$

in electrostatic units per centimetre of circuit,  $d$  (distance between wires) and  $r$  (radius of wire) being taken in the same units. We then have, at a voltage  $E$  between wires and frequency  $f$

$$\text{Charging current per mile of wire} = \frac{E^2 C 2 \pi f}{\sqrt{3} 10^6}$$

(The charging current of a three-phase line is  $\frac{2}{\sqrt{3}}$  times, or 15.5%, greater than the charging current of a single-phase line with the same voltage and distance between wires).

In Curve II., Fig. 1, is given the charging current in amperes per mile per wire with 10,000 volts between wires, the frequency being 60 cycles. From this curve the charging current for any line at any voltage or frequency may be calculated in a very few moments. Add 2% to the value obtained for a No. 2-0 wire, 4% for No. 4-0, etc., and subtract 2% for a No. 1 wire, 4% for a No. 2, etc. This rule practically holds for a half dozen sizes on either side of No. 0, for which the curve is calculated. This will include all sizes commonly used.

For wire, 3/4" in diameter, spaced 12 feet, the charging current is 0.0331 amperes per mile with 10,000 volts between wires. This is 4% less than for No. 0 wire spaced 48". Curve I gives the inductance per mile per wire at 60 p.p.s. For single-phase or two-phase, multiply by 1.15. For single-phase or two-phase, multiply the values of curve II by 0.87.

3. *Reactance Pressure.*—The self-induction in C.G.S. units per wire per centimetre may be calculated from the expression,

$$l = 2 \left[ \log_{\epsilon} \left( \frac{d}{r} \right) + \frac{1}{4} \right];$$

and the self-induction in henrys per mile per wire from the expression —

$$L = \text{henrys per mile} = 0.000,322 \left[ 2.303 \log \left( \frac{d}{r} \right) + .25 \right].$$

The percentage reactance pressure for a given current,  $I$ , at a given

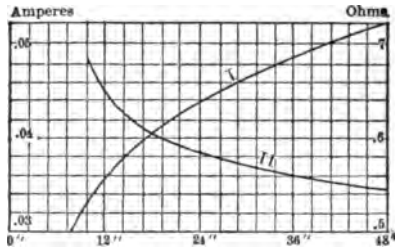

FIG. 1.—INDUCTANCE AND CHARGING CURRENT, NO. 0 WIRE.

frequency,  $f$ , may be calculated from the expression,  $X$  being the length of line in miles,

$$\frac{X L 2 \pi f I}{E \sqrt{3}} \times 100.$$

We see that in the formula for the reactance pressure we always have the ratio of the voltage between wires and length of line in miles. Assuming a given number of amperes flowing in the line, say 100, we may construct a curve between the percentage reactance pressure and the ratio of volts to length of line in miles  $= E/X$ . This has been done in Fig. 2, from which the percentage reactance pressure for any given case may be quickly determined. Curves are given for 12", 24" and 48" between the wires. The results are given for a three-phase line with 100 amperes per wire, fre-

quency — 60 p.p.s., size of wire, No. 0, B. & S. These curves bring out in a striking way the effect of reactance in the line, and the difficulties of regulation in long lines. For any other current, multiply the percentage reactance pressure by  $I/100$ ; for any other frequency multiply by  $f/60$ . For a single-phase, or two-phase system, multiply the percentage reactance pressure by 1.15. For No. 1 wire multiply the percentage reactance pressure by 1.02; for No. 2 wire, multiply by 1.04, etc. A great deal of labor may be saved by becoming familiar with the use of Fig. 2, in which the abscissæ are the ratio of  $E$  to  $X$ .

*Example.*—Voltage between wires — 50,000; distance between wires — 24"; length of line 100 miles. Then  $E/L = \frac{50,000}{100}$ , and from the curve, Fig. 2, we find the percentage reactance pressure for 100 amperes = 22.1. The reactance pressure in volts per loop will be  $.221 \times 50,000 / \sqrt{3} = 6390$  volts per wire.

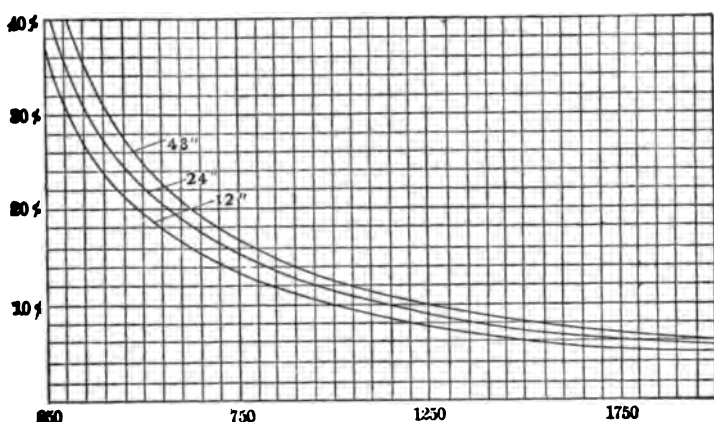

FIG. 2.—PERCENTAGE REACTANCE PRESSURE.

These curves furnish a method of quickly determining the percentage reactance pressure. For each size larger than No. 0 we subtract 2% from the values given.

*Rise in Pressure Due to Charging Current.*—It was shown in the paper first referred to that for all practical purposes the capacity of the line may be considered concentrated at the center of the line. This being the case, the rise in pressure is due to charging current flowing over the line reactance from the generator

to the center of the line and, hence, may be calculated by the expression: Rise in pressure  $= \frac{x L g \pi f}{2}$  (charging current), and the percentage rise in pressure will be this value divided by the line pressure and multiplied by 100. As the charging current varies as the line pressure the *percentage rise* in pressure is, therefore, independent of the line pressure.

4. *Regulation of Transmission System.*—Of prime importance is good regulation, it being impossible to give satisfactory service unless the ordinary fluctuations of voltage can be kept within 5%. This is not difficult with large induction motors, if the motors carry a fairly steady load. By large motors I mean from 500 to 1,000 hp. Smaller motors may have varying loads and not cause any noticeable fluctuations with lines 150 miles long operating at 50,000 to 60,000 volts. The most difficult load to handle is a large electric railway load having no storage battery. The only way to handle such a load successfully is to use automatically compounded synchronous motors. In this way street railway loads of any size may be handled by the same line supplying the lighting.

Since the method of calculating the regulation of a transmission system, as ordinarily carried out, is exceedingly laborious, a method<sup>1</sup> is here given which is very simple.

Taking the lost pressure over the system as a whole, we are always concerned with three pressures in any case: (1) The receiver pressure, (2) the lost pressure over the line, (3) the pressure delivered to the line. The lost pressure is made up, in any practical case, of the resistance pressure and the reactance pressure. When, as is generally the case, we have receiver loads of different power-factors, we get simpler results if we consider the total receiver current divided into two parts, one the power component and the other the wattless component of the receiver current, and regard each as flowing separately over the line.

If  $I$  is the total receiver current and  $\theta$  the angle of lag of the receiver current behind the receiver pressure, the power component of the receiver current is  $I \cos \theta$ , and the wattless component is  $I \sin \theta$ , ( $\cos \theta$  is the power-factor of the receiver circuit; for a non-inductive load  $\cos \theta = 1$ ; and  $\sin \theta = 0$ ). Let  $E = oa$ ,

1. "A Simple Diagram Showing the Regulation of a Transmission System of Any Load and Any Power-Factor." By F. G. Baum. *Electrical World and Engineer*, May 18, 1901. Also "An Alternating Current Calculating Device," by F. G. Baum.

Fig. 3 represent the receiver pressure. The pressure consumed by the line resistance and reactance due to the power component of the load current is  $I \cos \theta \sqrt{R^2 + (L\omega)^2}$ , in which  $R$  is the resistance and  $L\omega$  is the reactance of the line. In Fig. 3,

$$\begin{aligned}
 ab &= I \cos \theta R \\
 bc &= I \cos \theta L\omega \\
 ac &= I \cos \theta \sqrt{R^2 + (L\omega)^2}.
 \end{aligned}$$

$Ab$  is 8% of the receiver pressure; that is, the  $I^2R$  loss in line is 8% at full non-inductive load.

In Fig. 3,  $ac$  represents, then, in magnitude and direction, the pressure consumed over the line by the power component of the receiver current. If for a lagging current we make the angle

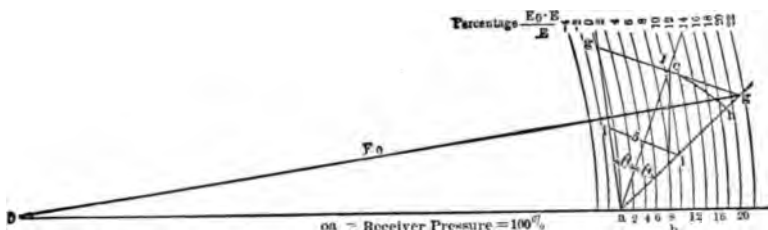

FIG. 3.— SHOWING METHOD OF DETERMINING REGULATION.

$cag = \theta$  ( $\theta$  is the angle by which the receiver current lags behind the receiver pressure), and the angle  $acg = 90^\circ$ , then

$$cg = I \sin \theta \sqrt{R^2 + (L\omega)^2},$$

as can be proved by simple geometry. That is to say,  $cg$  represents in magnitude and direction the pressure consumed over the line by the wattless component of the receiver current. (If the receiver current leads the receiver pressure by the angle  $\theta$ , the  $cg'$  is equal to the pressure consumed by the wattless component of the receiver current.)

It should be particularly noticed that the pressure consumed by the wattless current is at right angles to that consumed by the energy current. Notice also that  $ac$  is proportional to the power current, and  $cg$  to the wattless current. The true direction of the power current is along  $E$ , and the wattless current at right angles to  $E$ ,— downward for lagging, upward for leading current. The line  $ag$  therefore represents in magnitude and direction the pressure consumed over the line by the total receiver current. Hence,  $og$  represents  $E_o$ , the pressure delivered to the line, in magnitude and

direction.  $ac$  represents the pressure consumed by full-load non-inductive current. Then  $ac/2$  will represent half-load on line, etc. For half-load, and the same angle as before,  $E$  is given by  $oi$ . Through  $c$ , with  $a$  as center, a circular arc has been drawn. At full-load current, and a power-factor corresponding to the angle  $\theta$ , the value of  $E$  is given by  $oh$ .

With  $\theta$  as center, circular arcs have been drawn through  $a$ ,  $2$ ,  $4$ , etc. The radial distance between two successive arcs is  $2\%$  of the receiver pressure. We see, as shown by the point  $c$ , that the

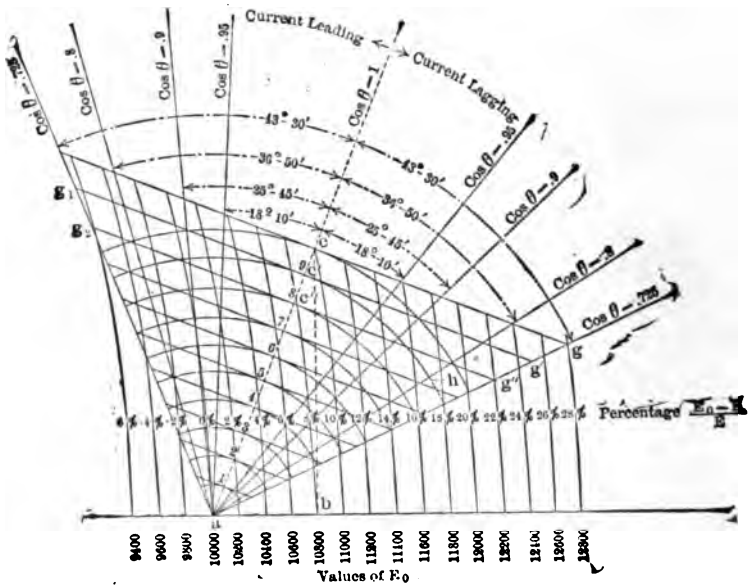

FIG. 4.— SHOWING REGULATION OF 15-MILE TRANSMISSION SYSTEM.

regulation of this system for full non-inductive load is 11%; that is, the generator pressure must be 11% higher than the receiver. At full kilowatt load, at a power-factor corresponding to the angle  $\theta$ , the regulation is 21%, as shown by the point  $g$ ; at full kilovolt ampere load; that is, for the same current as before delivered at the same power factor, the regulation is 19%, as shown by the point  $h$ .

In Fig. 4 is shown a case corresponding to a 15-mile transmission line, for a receiver pressure equal to 10,000 volts (the point  $o$  is not shown);  $ac$ , which represents full load, has been divided into ten equal parts, corresponding to 0.1, 0.2, etc., of full load.



Through points marked 0.1, 0.2, etc., lines have been drawn at right angles to  $ac$ . Radial lines making angles corresponding to  $\cos \theta = 0.95$ ,  $\cos \theta = 0.9$ , etc., for lagging and leading currents, having been drawn from  $a$ . Circular arcs, with the point  $a$  as center, have also been drawn through points along  $ac$  marked 0.1, 0.2, etc. The regulation for any load and any power factor may be determined from the figure.

For example, to find the regulation at full load at 0.8 power-factor, go along  $ac$  to  $c' = 0.9$ , then along  $c'g'$  to the intersection with the line  $\cos \theta = 0.8$ . The regulation is seen to be about 21½%. For 0.9 full-load current and the same power factor, the regulation is 17%, as shown by the point  $h$ . It is seen that for any given case it is only necessary to determine the triangle  $abc$ ; the remainder of the figure is drawn mechanically.

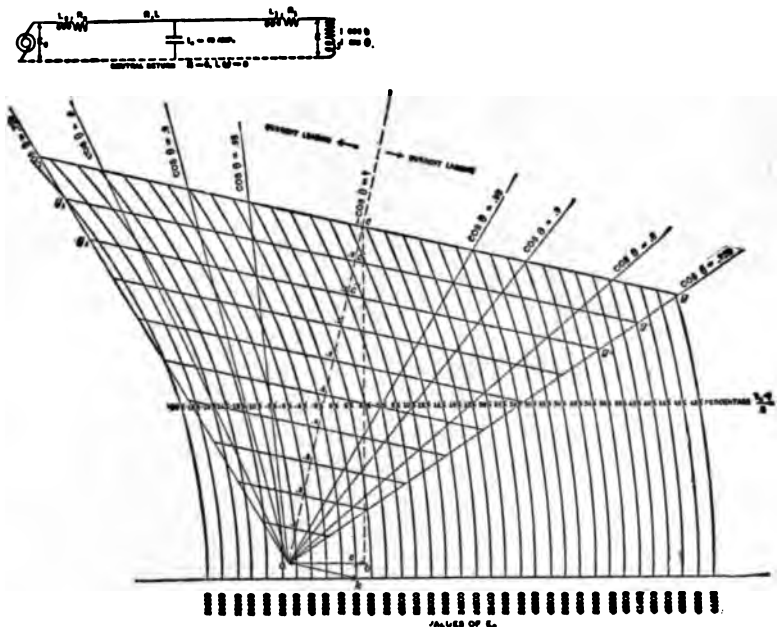

FIG. 5.—SHOWING REGULATION OF 150-MILE TRANSMISSION SYSTEM.

Fig. 5 shows the regulation of a 150-mile, 60 p.p.s., three-phase line for any load and any power-factor, with 30,000 volts between neutral and line wire, giving 51,960 volts between wires. The power transmitted is 3000 kw per leg, or a total of 9000 kw.

The small triangle *Kea* shows the rise in pressure due to the charging current. The regulation of the line for any load at any power factor is clearly shown. At no load, with 27,500 at generator, we get 30,000, or full voltage, at receiver, or a rise in pressure of 9%. The effect of a synchronous motor load of any character may be determined from the figure.

5. *Electrical Surges.*—We cannot avoid an occasional short-circuit on the high-voltage line. These shorts cause a heavy current to flow over the line, and the breaking of this current sets up surges which cause a rise in voltage that may be two to three times the normal operating voltage. The subject has been discussed by Mr. C. P. Steinmetz, Dr. A. E. Kennelly and Mr. P. H. Thomas. A simple method is here given, the matter having been first presented at the annual meeting of the Pacific Coast Transmission Association in 1902.

The subject is an interesting one to us, as we have all seen lightning arresters fused on account of the sudden opening of a circuit. I shall attempt to put the matter as briefly as possible, and in such a form that the rise in potential which we may get under the worst conditions may be easily and quickly determined. The most important case of opening a short circuit under load will be discussed.

*Opening a Line Under Load or Short Circuit.*—Let us consider the case of a long line with a receiver load concentrated at the end. The line capacity will be assumed equivalent to a single capacity at the center of the line. We will consider one leg of a three-phase system. The self-induction of one wire from the generator to the center of the line, that is, up to the assumed location of the capacity, is  $L$ , and the capacity of the entire line as a condenser is  $C$  ( $C$  being the capacity between one line wire and neutral). A current,  $I$ , flows over the line and is suddenly interrupted. As is well known, the energy stored up in the magnetic field (due to the current  $I$ ), between the generator and the center of line is  $LI^2/2$ . If the current is suddenly interrupted, this energy must flow into the line condenser, since there is no other outlet. (It should be noticed that when the receiver is opened, the line condenser is in series with one-half the line and the generator.)

If  $V$  is the resulting potential across the line condenser the energy stored up in the condenser is  $CV^2/2$ . But this is the

same amount of energy which was previously stored in the magnetic field, neglecting the small loss due to the current flowing over the line resistance in flowing over the line into the condenser. Therefore,

$$LI^2/2 = CV^2/2 \text{ or} \\ I = V \sqrt{C/L} = VC \frac{1}{\sqrt{LC}} \quad (1)$$

The current produced in a condenser of capacity  $C$  by an electromotive force having a frequency  $f$  is equal to  $E C 2 \pi f$ .

Comparing terms with (1) we see that  $\frac{1}{\sqrt{LC}} = 2 \pi f$ , in which  $f$  is the frequency of the current in the condenser. Equation (1) may therefore be written

$$I = VC 2 \pi f \quad (2)$$

in which  $f$  is the natural periodicity of the line. What really happens then when we interrupt the current  $I$ , is that the same current, having its natural outlet cut off, flows into the line condenser and charges the line. But the line condenser cannot remain charged, and, therefore, the condenser discharges again into the line self-induction, and the energy again is in the form of magnetic energy. The magnetic field, then, again breaks down, giving up its energy to the capacity and the whole cycle is gone over again and again, until the resistance of the line consumes the energy originally stored in the line self-induction. The frequency of the give-and-take of energy between the capacity and line self-induction is determined by the natural periodicity of the circuit  $f$ . The frequency of  $f$  in the equation (2) is therefore the frequency of the current  $I$ , after this current has been interrupted at the receiver. If the circuit is working normally at a frequency  $f'$ , the current  $I$  changes from a frequency  $f'$  to a current of frequency  $f$ , that is, from the normal impressed period to the natural period of the circuit.

The natural periodicity of a circuit may be easily found from the equation

$$2 \pi f = 1/\sqrt{LC} \\ f = 1/2 \pi \sqrt{LC} \quad (3)$$

For a three-phase transmission line we may take the self-induction for one-half the line, for one wire, as .08 henries per hundred miles, or  $L = .08 D$ ,  $D$  being the length of line in hundred miles.  $C$  may be taken as two microfarads per hundred miles, or  $C =$

$2 D/10^9$  farads. Substituting for  $C$  and  $L$  in equation (3), gives us approximately

$$f = 400/D. \quad (4)$$

This frequency will not differ much for different distances between wires, because an increase in the distance will increase  $L$  and decrease  $C$ , the product remaining nearly the same. The same is true for different sizes of wire. That is, a line 100 miles long has a natural periodicity of about 400; a 200-mile line a periodicity of 200, etc. If we are operating normally at 60 cycles, a 200-mile line has a natural periodicity of little more than three times the frequency of operation.

From (2) we get the potential across the line condenser due to interrupting the current  $I$  equal to

$$V = I/C \ 2 \pi f. \quad (5)$$

Substituting for  $C$  the value  $2D/10^9$ , and for  $f$  the value  $400/D$ , we get the simple equation

$$V = 200I \text{ (approximately)}. \quad (6)$$

That is, the rise in potential due to the surging current is, as a first approximation, independent of the length of the line and equal to 200 times the interrupted current in amperes. If  $I$  is equal to 100 amperes (141 amperes maximum), and the current is interrupted when it has its maximum value, then

$$V = 200 \times 100 \sqrt{2} = 28,200 \text{ volts.}$$

Interrupting 200 amperes would give us double this rise. This electromotive force will be superimposed on the line electromotive force, so the maximum strain possible for any interrupted current is

$$\text{Maximum strain} = E \sqrt{2} + 200 I \sqrt{2}.$$

$E$  is the voltage between line wires and neutral, and  $I$  is the current in amperes interrupted. It has been frequently noticed that a line having been short-circuited, and the short circuit broken, the arc will frequently re-establish itself or a new short start at some other place between points across which the line voltage could not jump. The superposition of the oscillating electromotive force due to the removal of the short circuit to the line electromotive force is no doubt the explanation. We have assumed that the current is instantly interrupted. An arc will always be formed which will reduce the rise in potential.

On account of the inductive drop over the line, it is very probable that the current to be transmitted over one wire of a long distance transmission (150 to 200 miles) must be limited to about 100

amperes, unless the frequency is reduced below sixty. One hundred amperes, at sixty cycles, transmitted over a line 200 miles long gives us an inductive drop of about 50 per cent, with 50,000 volts between wires. The generators will probably deliver four times full-load current as a maximum on short circuit. A short-circuit in the center of the line would, therefore, give us about twice full-load current, so that the maximum rise in potential due to the interruption of the short circuit would be about 56,000 volts. If the line is operating at 30,000 volts (equals  $30,000 \sqrt{2}$  maximum) between neutral and line wire, the strain would be a little more than twice the normal. Under certain conditions a greater rise may take place.

It seems, therefore, that there is a limit to the amount of power that can be transmitted over a line, which limit is fixed by the insulation factor against the surge voltage. If we reduce the frequency of the transmitted current to 25 or 30 cycles, so that we could transmit, say, in the neighborhood of 500 amperes over a single line without having excessive reactive drop, then we must insulate for the normal working pressure, say, 30,000 plus the surge voltage, which in this case would mean insulation to withstand a voltage of 185,000 volts as shown below—

$$\begin{aligned} \text{Strain} &= 30,000 \sqrt{2} + 200 \times 500 \sqrt{2} \\ &= 130,000 \sqrt{2} \text{ volts} \\ &= 185,000 \text{ volts.} \end{aligned}$$

In other words, we must make our insulators and transformers stand a repeated momentary pressure of about 200,000 volts.

To transmit the same power at 60,000 volts, reducing the current transmitted to 250 amperes, would cause a smaller total strain due to the surge. The enormous strains introduced when we come to transmit from 25,000 to 100,000 K.W. over a single line will require extraordinary insulation against rupture due to the line surges.

In the above we have assumed a long trunk line with a receiver at the end. When the receiver current is interrupted the line current is forced into the condenser. On our long lines, however, we usually have loads distributed along the entire length, and if there is a load on at different points the line discharges a portion of its energy into the local distributing circuits, and the rise in potential is therefore limited.

The amount of energy stored in one-half of a 100-mile line is

quite small, yet it may do considerable damage. For 200 amperes it is

$$L I^2/2 = \frac{.08 (200)^2}{2} = 1600 \text{ joules};$$

that is, 1600 watts for one second.

We see from the above that the most dangerous condition is brought about when we suddenly open a short circuit. Curve I. in Fig. 6 shows the calculated oscillating potential due to interrupting 150 amperes on a line about 130 miles long. Curve II. shows the generator potential (60 cycles) and Curve III. the resultant line potential. The line voltage is 25,000 between neutral

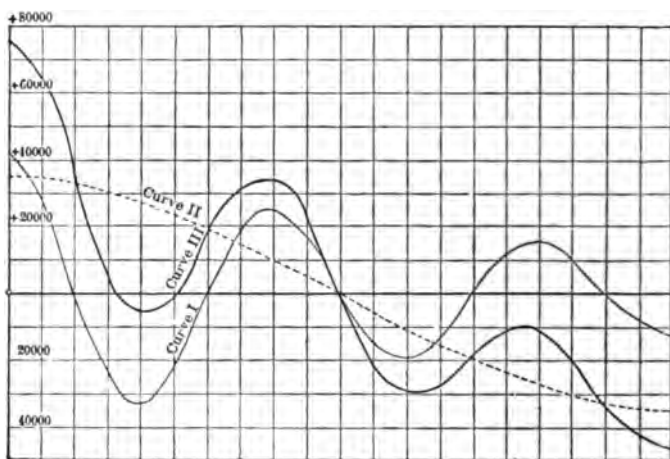

FIG 6.— SURGE VOLTAGE ON TRANSMISSION LINE.

and live wire. The current is interrupted so as to produce a maximum rise of potential.

The resultant potential, we see, is very different from the impressed generator pressure. If we continue to lengthen our lines until the natural periodicity of the circuit becomes nearly equal to the impressed periodicity, it is very probable that we will have some new problems to solve. It may be that this will prove the determining factor which will limit the distance of transmission.

## PART II. HIGH POTENTIAL CONTROL.

1. *Insulators.*— We have on our lines practically every type of insulator manufactured. We have glass insulators, porcelain insulators and combinations of porcelain and glass having from one

to four parts. In the mountains and away from the fog, a 7-inch glass does very well on 40,000 volts, but to go from 40,000 to 60,000 requires that the insulator be increased more than the proportionate increase in voltage. The insulator shown in Fig.

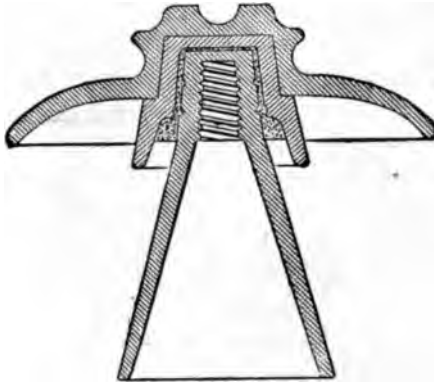

FIG. 7.— 40,000-VOLT, 11-INCH PORCELAIN INSULATOR.

7 is used up to 50,000 volts, but at this voltage it gives trouble in the fog districts and during wet weather. Insulators of the types shown in Figs. 8 and 9 give very good results and are probably

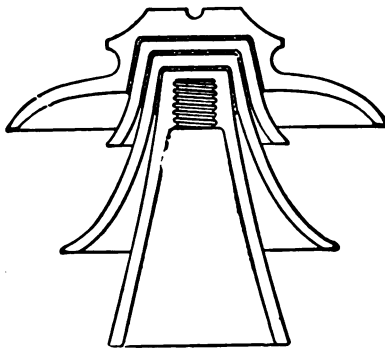

FIG. 8.— 60,000-VOLT, 14-INCH PORCELAIN INSULATOR.

as good as can be obtained at present. Fig. 9 has been designed by the engineers of the California Gas & Electric Corporation.

As the time will probably come when 100,000 volts will be as common as 10,000 is today, we have not yet reached the limit of development in line insulation.

In testing the insulators, each part is subjected to more than the normal voltage from line to ground. The top is generally tested to 55,000 volts, the center to 45,000 and the middle petticoats to 40,000 volts. The test is made with salt water as electrodes.

2. *Pins.*— We are using iron pins on all our new work, and believe the idea of depending on the pin for insulation is wrong. Place the strain where it belongs — on the insulator. We are making our pins of pipe drawn down at one end. The pins are galvanized and a lead thread then cast to fit the insulator.

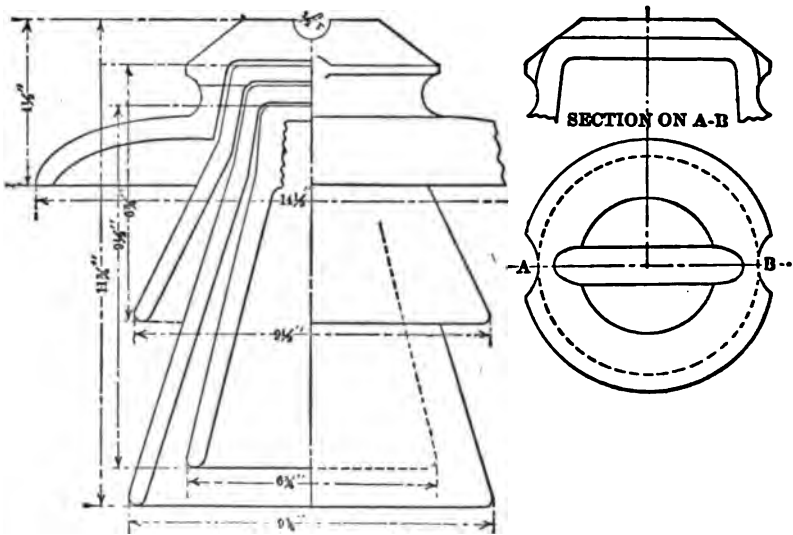

FIG. 9.— 60,000-VOLT, 14-INCH PORCELAIN INSULATOR.

3. *General Line Construction.*— We are constructing our 60,000 volt lines with a 6 ft. spread, the wires being on the corners of a triangle. On our late work we are using tall poles and spreading about double the distance ordinarily used. In the mountains where we can take advantage of the hills and ravines, we use long spans, having some aluminum spans of 1000 to 1800 ft. in length.

A tower construction using a span of about 500 ft. would make an ideal line, and a line not much more expensive and much easier to care for than the ordinary pole line.

Our method of entering buildings is through a piece of plate glass about 24 inches square having a hole about 3 inches in diameter through which the wire passes. The glass is held by a



simple wood frame. This construction is more satisfactory than the old method of passing through terra-cotta pipes.

4. *Line Operation.*—The lines are operated by keeping men at important points who patrol the lines from one to three times a week, depending on the condition of the line, these men being ready at all times to go out in case of emergency.

Our line troubles have been due to a few weak insulators; in some localities we have a good many insulators shot off. Some of our unexpected causes of trouble have been cranes or geese flying into the line; cats climbing up on the poles; green hay carried by wind dropped on the line; an engine starting up under the lines; a long tailed rat crossing temporary bus-bars.

5. *Transformers.*—Our transformers have given us very little trouble and are really the most satisfactory part of the system. High primary insulation and care in the handling of the oil to keep it free from dirt and moisture are of prime importance. The windings should be dried out before adding the oil.

That the presence of the oil does not increase the fire risk was amply demonstrated by a fire at the Colgate station in March, 1903. The transformers were in the hottest part of the fire and were damaged but little, the oil acting as a protection to the winding. The transformers were not responsible for the fire, as was reported at the time.

On test, the primary of each transformer should stand a test about equal to double the star voltage for which the transformer is designed. That is, a transformer which is to be connected 30,000 star, giving 51,960 volts line pressure, should stand an insulation test of about 100,000. Some manufacturers put on a test voltage from two to three times the transformer voltage. Less than two and one-half is not a good test.

6. *Switches.*—We find it convenient to use two types of switches to handle the electrical energy, the oil type and the air type. That the oil type switch is the only one that will stand heavy duty has been amply demonstrated. As it has not been possible to purchase satisfactory switches in the market, I have designed a line of switches for our high potential work.

We are now using the switches shown in Fig. 10 at our power houses, designed to handle from 10,000 to 40,000 kw at 50,000 or 60,000 volts. Each pole is in a separate tank and mounted in a fire-proof compartment as shown in Fig. 11. The three poles are operated together. The switch as shown gives four breaks per leg.

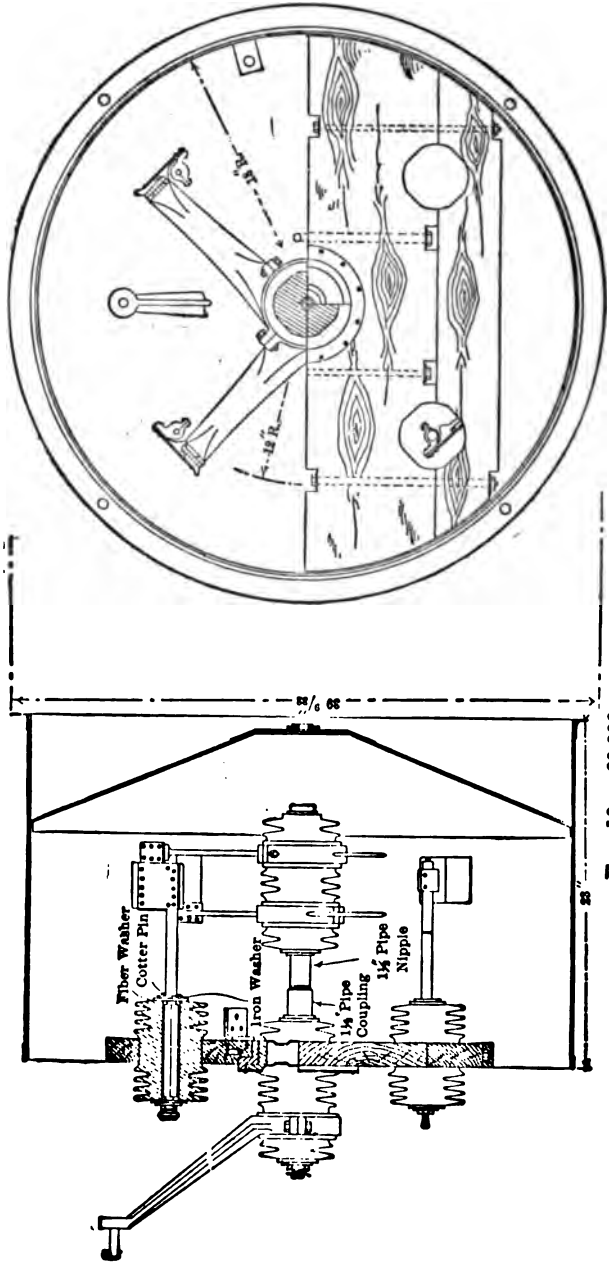

FIG. 10.—60,000-VOLT, FOUR-BREAK, OIL SWITCH.

On less important work we use the two-break switch shown in Fig. 12. This is a very simple and inexpensive design, but answers all purposes as well as more elaborate switches. Switches having the same operating principle, but mounted differently, designed by Mr. R. H. Sterling, have been in service on the system for

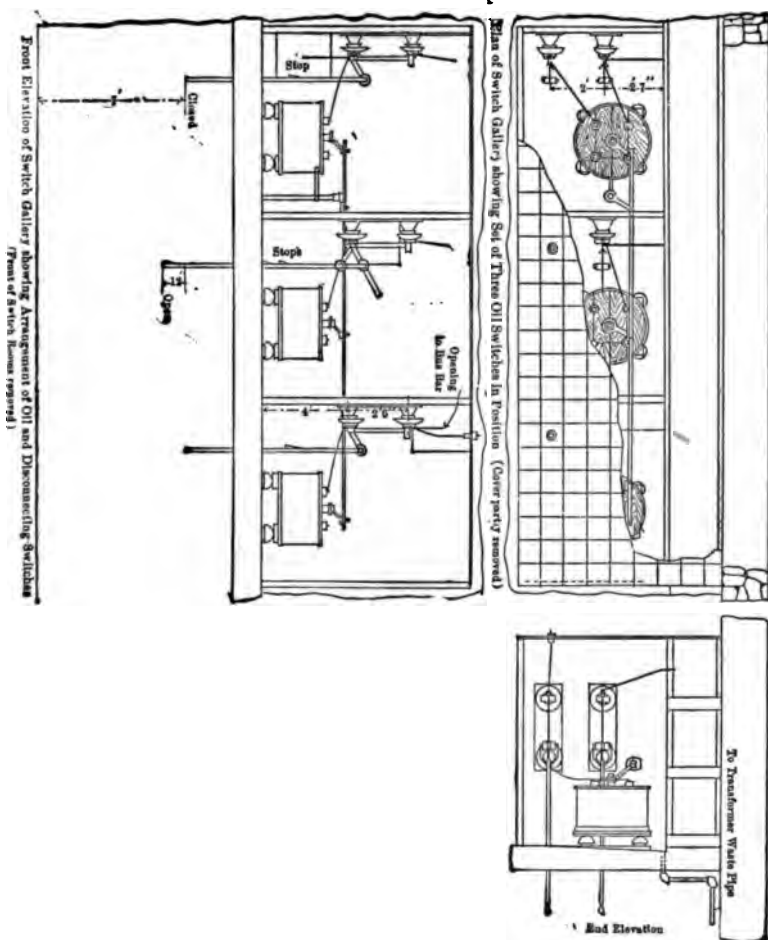

FIG. 11.— 60,000-VOLT, FOUR-BREAK, OIL SWITCH IN PLACE.

several years and have given very good results. This switch will open 10,000 K.W. at 60,000 volts on short circuit.

Disconnecting switches are used on each side of the oil switches, as shown in Fig. 11, that the switch may be examined and repaired with line and bus-bars in service.

For connecting transformers to bus-bars we use three pole disconnecting switches, as shown in Fig. 13. This is a simple design and works perfectly. Fig. 14 gives a large view of the switch. As shown by Figs. 11 and 13, each bus-bar is run in a separate duct.

For an outdoor switch for substations and branch lines where the load does not exceed about 1,000 K.W., we use the switch shown in Fig. 15. The switch is mounted so that the three poles open simultaneously from a distant point.

Electrically all switches on the system are liable to have the

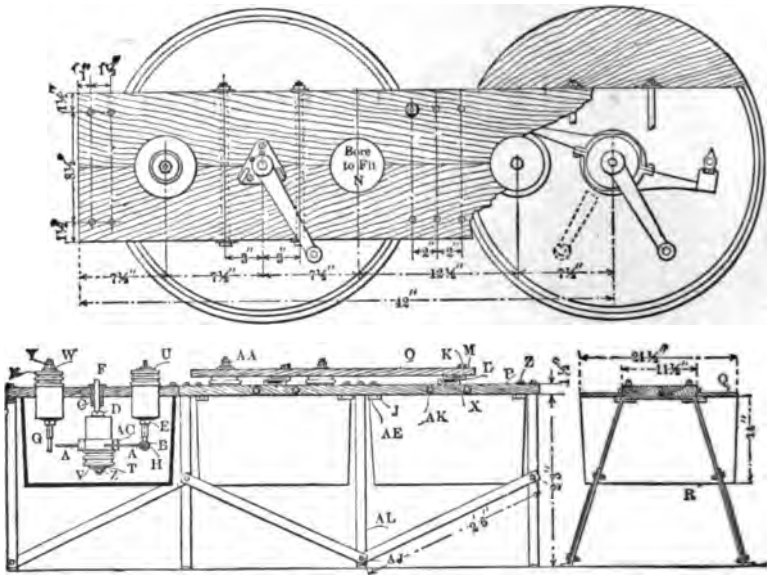

FIG. 12.— 60,000-VOLT, TWO-BREAK, OIL SWITCH.

same duty to perform in case of a short-circuit beyond the switch, and some make it a practice to have all switches the same, depending on the power behind them. While this is correct electrically, the liability of trouble is slight and it is better to assume that you will occasionally burn up an inexpensive switch by trying to open on a short than it is to burn up all your money in the beginning by installing every switch of a high capacity, and at great expense.

7. *Lightning Arresters.*— For lightning protection we have decided to pin our faith to the horn arresters, these made with single

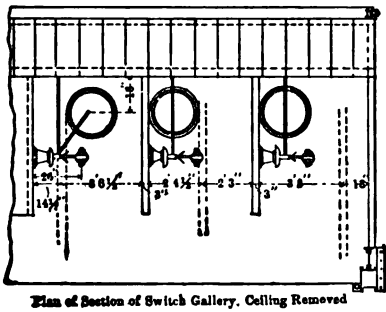
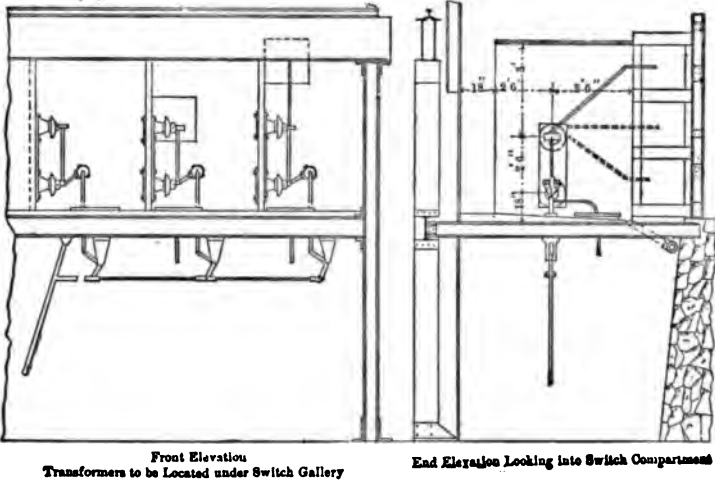

FIG. 13.— 60,000-VOLT DISCONNECTING SWITCH.

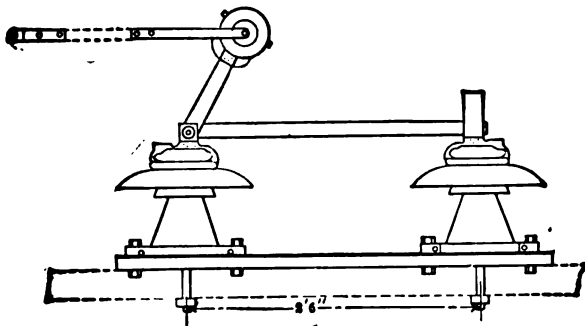

FIG. 14.— 60,000-VOLT DISCONNECTING SWITCH.

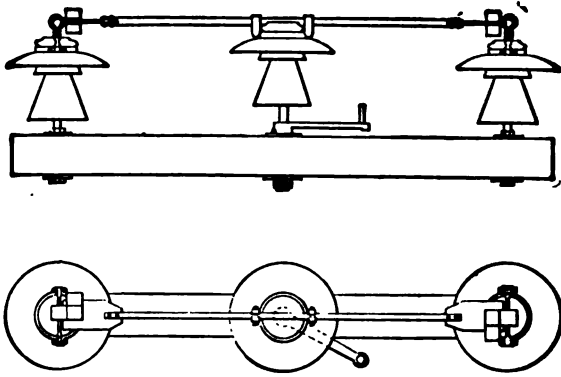

FIG. 15.— 60,000-VOLT OUTDOOR LINE SWITCH.

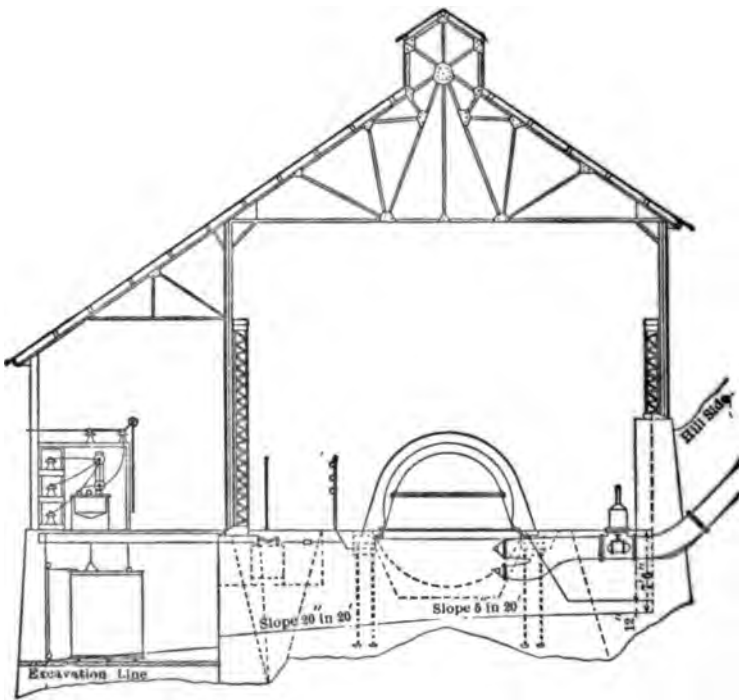

FIG. 16.— SHOWING GENERAL ARRANGEMENT OF POWER-HOUSE.

or double air gap. This simple device with good transformer and line insulation has given good results. Lightning is very often blamed for troubles that are primarily due to insufficient insulation and ignorance.

8. *General Arrangement of Power House.*— Fig. 16 shows my idea of the general arrangements of a power house in the mountains. Our high-head power stations are usually in deep canyons and the logical method of construction, it seems to me, is to take advantage of the natural slope as shown. We go from the generator through the 2300-volt switch located under the floor, then to the transformers, which are located on a lower level than the power house, with the floor left open so the operator can see the transformers and note the temperature on the dial. The floor level of the transformer room may be below the high water line. From the transformers we come up to the disconnecting switches, then through the oil switches to a second disconnecting switch to line. Locating the transformers in this way puts them in view of the operator, the practice of constructing a separate transformer room at a distance being wrong, in my opinion.

For fire walls we have the tail races between banks. I have yet to see a transformer in trouble that could not be pulled off before anything more than an injury to the coils had resulted. The switches being located in fire-proof rooms makes it impossible for fire to spread in any way. The arrangement given, it is believed, has a great many advantages, being compact, safe, easily operated and economical.

Our general practice is to generate at 2300 volts and step up to the line voltage, the primary of transformers being connected star with grounded neutral. I have come to believe the grounding of the neutral to have more advantages than disadvantages. We take advantage of the grounded neutral and very often install a single transformer in a substation, one side going to line, the other to ground; where the load is larger but does not warrant three transformers, we put in two, using two legs of the primary and open delta on the secondary. We are not bothered by any unbalancing of load at the power houses.

At the power houses we use no fuses or circuit breakers, preferring to hang on to a short rather than take chances of pulling the line off for every slight interruption. At substations the transformers are generally fused.

The size of our units has gradually increased from 300 kw, installed in 1897, to our present 5000 kw units. The 5000 kw unit is of the two bearing type with overhanging water wheel. With this type we can put 20,000 kw in a building 100 ft. long  $\times$  50 ft.

9. *Line Voltage.*—Regarding the proper voltage to be used for transmission, this will depend on conditions, mainly on the length of line. From 50 miles up it will be generally economical to use as high a line voltage as is practicable. At the present time 60,000 volts can be safely handled and 80,000 volts is not out of reach in certain localities by those experienced; and judging the future by the past we may expect to reach 100,000 operating voltage in a few years.

Our greatest trouble is occasioned by the fog. This in districts near the ocean or bay settles on the insulators and reduces the insulation to such an extent that the pins, cross-arms or poles — if of wood — are set on fire. In the mountain districts with modern insulators our line troubles are practically nil. Those without experience in the fog districts cannot realize the difficulties of insulating against a heavy fog.

The weak point of the transmission system is in the insulators. With an insulator to stand 100,000 volts, this pressure is possible.

To sum up, my experience shows that it is easier to operate a line, say from 30 miles up, at 50,000 or 60,000 volts than at 25,000 or 30,000 volts, assuming that a considerable amount of power is transmitted.

#### DISCUSSION.

Mr. WM. MORAN: I would like to ask Mr. Baum a few questions in reference to the air gap offered between his circuit and the lightning arrester grounds. I wish to know the number of gaps.

Prof. BAUM: Well, that altogether depends, I think, on the voltage. We are now using an air gap from a line to ground of, I think, 4 inches or 4½; but it doesn't make much difference which it is. The line voltage is 50,000.

Mr. MORAN: So the sixteenth-of-an-inch per thousand stands good in your voltage, practically?

Prof. BAUM: Practically.

Mr. MORAN: Then again, what is your voltage in the metropolitan cities, if you pass through any?

Prof. BAUM: We are passing right through the city of Oakland with 50,000 volts.

Mr. MORAN: Any trouble with telephone people?



Prof. BAUM: Not with the telephone people — the politicians sometimes bother us.

Mr. MORAN: I am handling 30,000 volts and am limited on account of telephone people. A question arises, in connection with this high voltage, as to whether you are not confined by localities rather than to voltage. I am on railroad work at 30,000 volts and we were held down to 30,000 by injunctions.

Mr. N. J. NEALL: I would like to ask Mr. Baum what the difficulties are with the arresters when they operate. Suppose you have two arresters to operate simultaneously; what is the effect upon the regulation and how long does it take to extinguish the arc?

Prof. BAUM: I don't know. We hear every once in a while that some arrester has operated with a very vicious arc. Generally the power-house man does not know anything about it. We have never been shut down on account of anything of that kind. There is the ordinary drop of voltage, of course. The induction motors are affected. The synchronous motors are thrown out of step but they get in soon afterward.

Mr. NEALL: Then I assume from your answer that no two arresters are operated at the same time, and that you have not had the effect of a short-circuit over your lightning arresters?

Prof. BAUM: Oh, yes.

Mr. NEALL: You say you have nothing more than a drop of voltage at your generator?

Prof. BAUM: A drop in the voltage may have occurred. When it has occurred we had to pull off but we don't know why we pulled off. That broke the arc, if nothing else broke it; but we cannot prove that.

Mr. NEALL: Would you not, generally speaking, consider it an objectionable feature in lightning-arrester operation, that you have to pull off when your arresters operate?

Prof. BAUM: I am not sure that we have had to pull off. Until I am you cannot sell me any high-priced lightning-arresters.

Dr. F. A. C. PERRINE: In reference to this discussion, during the switching experiments that Mr. Baum just described, where they interrupted 12,000 kw with a two-break switch, the line short-circuited across two 4½-inch gaps, across horn arresters, but it burned up the arresters, the pole head and the No. 0 ground wire.

Prof. BAUM: That was after about the tenth time.

Dr. PERRINE: Yes, it was after about the tenth short broken by the switch when these arresters arced across.

Mr. NEALL: May I ask whether you had resistance in those arresters at that time?

Dr. PERRINE: None. It was a dead short-circuit at the power-house. We were operating four 2000-kw machines, and the voltage held constant. The ammeters, at the time the switch was opened indicated a current equivalent to 12,000 kw or something beyond. Immediately after we had interrupted the circuit, the lightning arresters at the power-house short-circuited.

Mr. NEALL: There was no resistance in that connection between the two arresters?

Dr. PERRINE: No resistance at all. It was a dead short-circuit between the two lines.

Mr. MOBAN: May I ask if you have tried the multiple-gap arrester and with what results? That is, a number of small gaps instead of one large gap.

Prof. BAUM: I don't want to say anything against any lightning-arresters, but we have used every lightning-arrester that is made, I think, with the exception of one. We have used every type of multiple-gap; the result is that we put them out of business, can't make them stay on the line; we burned them up.

Mr. MOBAN: Is that on account of static effect, running down half way on the arrester?

Prof. BAUM: No, it is current burning it up; short-circuit.

Mr. MOBAN: Have you any static interrupters on the line, dischargers?

Prof. BAUM: None whatever.

Mr. NEALL: I would like to ask one more question in regard to these arresters. Last year when I was out visiting this line I found the horn-arresters had resistances in series with them. What time were they installed and what was the object?

Prof. BAUM: There are some that have resistances in series and some that have not. I think there are two with resistances in series and the remainder have not. We do not notice any difference in the operation of the arresters, whether they have resistances in series or not, although I prefer the resistances in series. That is, a resistance between the arrester and the ground.

Dr. PERRINE: But that is not resistance between lines.

Prof. BAUM: No.

Dr. LOUIS BELL: I would like to ask Mr. Baum where these lightning arresters were located on his line; how many of them were used?

Prof. BAUM: At various points (indicating on blackboard).

Dr. BELL: Then they are put in at discretion, at points which may seem possible danger points, and nowhere else?

Prof. BAUM: No.

Dr. PERRINE: If I understand you correctly they are only put in at terminals.

Prof. BAUM: They are put in at the power-house also.

Dr. PERRINE: They are not put in at intermediate points, are they?

Prof. BAUM: No.

Mr. NEALL: What is your idea of the best resistance for an arrester of that kind?

Prof. BAUM: I haven't any particular idea.

Mr. NEALL: What type of resistance are you using?

Prof. BAUM: We have a number of carbons connected in series—high-resistance carbons; some of these are immersed in oil.

Dr. BELL: How high resistance do you use in those arresters between line and ground?

Prof. BAUM: Well, I couldn't tell you exactly as I did not put in that particular resistance. Mr. Bunker is here and he could tell you.

Mr. NEALL: Have you made any investigations to determine the result

on the line when one of these arresters discharges? It seems to me, looking at it broadly, if you have got to wait until your voltage rises sufficiently to leap four inches and a half, that there may be other points of your line to give way before that is reached, and the very presence of the horn-type arrester necessitates a very abrupt disturbance on the line to make it operate.

Mr. E. F. OGLE: I would like to ask a question in reference to the insulators in Fig. 7 and Fig. 8 of the paper. With the type of insulator shown in Fig. 7, have you any trouble with the snow freezing in between the petticoats, or don't you have any snow?

Prof. BAUM: We have practically no snow on our lines.

Mr. OGLE: Do you have any trouble with the cement that holds them together freezing?

Prof. BAUM: No.

Mr. M. H. GERRY: Let me ask Mr. Baum a question before we get away from this lightning arrester. Do I understand Mr. Baum that he had a 10,000-kw — or perhaps 25,000-kw — capacity short-circuit on that 4½-inch gap, and that the arc broke on the arrester without the necessity of pulling off, or anything happening?

Prof. BAUM: The lightning arrester was outside.

Mr. GERRY: How far from the generating point?

Prof. BAUM: Ninety-eight miles. The short-circuit produced a surge in the line, breaking down the 4½-inch air-gap. This shows a rise of voltage to something like 100,000 volts. That is, the two 4½-inch air-gaps to ground would mean somewhere around 90,000 or 100,000 volts. A number of times on this lightning arrester the arc would break with 8000 kw on the line. The last time it simply burned up.

Mr. GERRY: How much capacity was on the line?

Prof. BAUM: 8000 kw of machinery.

Mr. GERRY: I think there would be somewhat more capacity on short-circuiting across the lightning arrester, perhaps 15,000 kw.

Prof. BAUM: Certainly.

Dr. PERRINE: We read 12,000, 15,000 kw.

Prof. BAUM: The ammeter needle went off the scale, and the arc just simply raised up and broke.

Mr. GERRY: And there was no serious drop of potential — 50 per cent, 75 per cent — across that gap?

Prof. BAUM: Well, it is a pretty difficult thing to read a volt meter on a station line in a condition of that kind, I think you will realize.

Mr. GERRY: Well, if it went to anything like, say, 25 per cent voltage, it seems to me the induction motors might drop off.

Prof. BAUM: This line was simply on test at that time.

Mr. GERRY: There was nothing on it.

Prof. BAUM: No.

Mr. GERRY: Then it practically amounts to a short-circuit when one of those arresters goes off?

Prof. BAUM: Yes.

Mr. GERRY: Then, every time the horn-arrester goes off you have a short?

Prof. BAUM: A temporary short.

MR. GERRY: Then every time the horn arrester goes off you lose your load or part of it?

Prof. BAUM: A part of it.

MR. GERRY: Then the horn arrester is simply a device that produces a short-circuit on the line at every time the current follows into the arrester?

Prof. BAUM: Yes.

MR. GERRY: And you lose your load?

Prof. BAUM: Some of the load. You must remember that we do not have these arresters going off every day. For one year now I cannot recall the lightning arresters going off once. The last time they went off was when we made this test and I can't remember them going off since.

MR. GERRY: Why don't they go off? Isn't there any lightning or doesn't it go through the arresters?

Prof. BAUM: There isn't lightning enough to bring it up to the 4½-inch gap.

MR. GERRY: Well, isn't that what breaks the line then? If the gap was larger wouldn't you have still less trouble, and if you took the arrester off all together, still less?

DR. BELL: In case a short-circuit or fault somewhere back on the line produces a short across the arresters, does that short uniformly hold for any considerable length of time? In other words, does it hold until it practically takes the arrester with it, or does it break; and if it does break how long does it take in doing it?

Prof. BAUM: Well, you can realize that in a system like this which covers five or six or seven counties, that I or one of my men cannot be at the arrester watching.

DR. BELL: I understand. But has not the action of the arrester ever been observed, to see when it breaks successfully. How long does it hold before breaking?

Prof. BAUM: In case of this arrester it broke a number of times up to a year ago. Then we moved the lines farther apart. The man would report once in a while that the arresters went off. Nobody else reported any trouble whatever. At one point a man, a year and a half ago or two years ago, reported that the lightning arresters went off.

MR. GERRY: Well, did they short-circuit?

Prof. BAUM: There was a big flaming arc. We moved the arresters a little farther apart. Since then we have had no discharge at this place, and no trouble at all.

DR. BELL: In other words, do I understand that the arresters, at least now and then, go off and operate successfully, without causing disturbance enough at the power station to say whether that break was instantaneous or whether it lasted two or three seconds?

Prof. BAUM: We don't know.

DR. PERRINE: I think in catechizing Mr. Baum on the question of his horn-arresters, we are getting away from the point of this paper, which is practically stated by Mr. Baum when he says that on such a system of

transmission as this, he would use the highest possible voltage. He is having less troublesome experience at 55,000 — which is about the voltage I understand he is running now — than he had at lower voltage, and he ascribes this largely to the relatively smaller value of the voltage when a surging current is interrupted. In consequence, he believes that it is advisable to keep down the current on the line, keeping up the voltage, for the reason that it makes these minor devices, such as lightning arresters, relatively unimportant. It is not the important point to catechize Mr. Baum on whether he has set his arresters at 3½ inches, or used mutiple gaps, or what. The point that he has made in his paper is, that by going to this high voltage and keeping his current down, he has made the minor difficulties, which have troubled us all so much, relatively unimportant. That, I think, is due not only to his high voltage on long lines; but also to the presence of multiple stations which feed into the line from all directions and which feed a very large amount of power, so that while in our discussion we may say that a short-circuit reduces the voltage on the line beyond it to nothing, we say that not knowing what actually happens. We may have a short circuit across an arrester or between lines, across a piece of bale-wire thrown on the line, which may, as Mr. Baum has stated, result in a relatively small current; so that beyond that point, if we have generating capacity enough behind us, we will still get voltage, and although we may have these minor interruptions, they will not interfere with the service. The paper of Mr. Baum is notable to me particularly in the fact that he does not discuss as difficulties many of the problems that we have been discussing in our transmission papers during the past year. For example, when the first of these lines began operation the question of the capacity effect became very important. Until Mr. Baum introduced the exciter device which he has already described to us, one long-distance transmission system could not operate a lighting load on account of troubles with capacity, and, in consequence of capacity troubles, we have often discussed the use of motor-compensators. You will notice that in Mr. Baum's paper there is not any mention of any necessity for these artificial regulating conveniences, except when the question arises of operating large street-railway plants with their variable load. So that on account of high voltage, keeping down current, and the great number of stations feeding the line from different directions and different points, a very satisfactory solution of the switching problems has been reached; as well as an apparently satisfactory approaching solution of the insulator problems. In this great system, operating a total of about 700 miles of high-potential lines, and operating two stations in parallel, 325 miles apart, he gets rid of the troubles which some stations have when carrying relatively small amounts of concentrated load of one kind, operating single lines. The success of this system is the success of a system which is operated as a whole, and it is not only the lightning-arrester difficulty which largely disappears, but it is also the capacity difficulty and the inductance difficulty and many other difficulties which also largely disappear. It is firmly my opinion that the great success of this long-distance transmission is due to its apparent complexity.

Dr. BELL: I think the whole profession owes a debt of gratitude to Mr. Baum for his practical researches on these problems that have been bothering us all more or less. But Apropos of what I think Dr. Perrine has just said, I cannot help feeling that there is a phase of the matter that we are justified in presenting to Mr. Baum's attention. A great system like this, the greatest transmission system in the world, may not have immunity from all troubles. When you feed from half-a-dozen points and have thirty load points, trouble no longer embarrasses the system as a whole, so that many of the difficulties are simply minor local troubles. Nevertheless, this is not a normal transmission line. It is a wonderful and exceptional one, on which Mr. Baum has been privileged to experiment. If we had instead of such a system a straightaway system of 10,000 kw for 75 or 100 miles, and the same troubles, of short circuits over the arrester<sup>s</sup>, etc., came upon it, it would not mean an incident in the system; it would probably mean losing the whole load, with all that this implies. So that while these difficulties can be passed over as minor in a splendid large system with a considerable number of feeding points; they become major difficulties, perhaps controlling difficulties, under almost precisely similar circumstances as regards construction, when we deal with a single line on which anything happening puts the whole business of the company out of commission for a longer or shorter period. That, I think, is why we pressed home some of these questions which are not intended as criticisms at all, but merely to get Mr. Baum's valuable experience on some of them. As respects the high-voltage proposition, I have always believed that when you passed over the moderate, and comparatively insignificant voltages of the past, the 10,000 volts or so which was used so extensively, the proper thing to do was to play the limit fairly, and it seems to me one of the great advantages of playing the limit is not only immunity from surging — I have seen the terrific effect of it at three or four thousand volts — but the fact that when you are insulating for 50,000 volts, you are planning the details of the line with a respectable factor of safety, to which most of the minor troubles, including all the minor lighting discharges, become insignificant. In other words, when you are insulating for 60,000 volts as thoroughly as Professor Baum is insulating out there, the ordinary induced lightning flash — what we generally know as lightning on the line — is merely an incident; it is merely what might as well be a part of a surge in voltage, a part of any extra rise in voltage, but cuts no figure there with respect to the margin of insulation of sixty or seventy-five thousand volts which you have left. I think the secret of these high voltages lies not only in the diminution of the surging troubles, which of course takes place just in that way, but also the fact that you have a tremendous factor of safety, and it gives, all of us, I think, courage in attacking the problems of the future to know of the great success which Mr. Baum has had on this big system, and the extent to which the insulation precautions, which he has taken, overcome these minor difficulties.

MR. MORAN: I would like to ask one or two more questions from Dr. Perrine and Mr. Baum. As I am not thoroughly familiar with the

systems, I wish to ask if you have one circuit on lighting and one circuit on rotary-converter power?

Prof. BAUM: All together.

MR. MORAN: What I was driving at is that I wish to try to find the relative trouble, if any, on a rotary load and a lighting load on such a long-distance system.

Prof. BAUM: The lines are operated altogether; everything is in parallel; the lighting load is taken off from the same line that the motor load is taken. Up to a year ago the Northern system was independent of the other system, and we supplied its load from one power house, which was a straightaway system, load of course being taken all along the various points. During that time we had very great success with the continuity of service. To give an instance, at one point there were two 800-hp motors driving machinery in a cement plant. We have a record of those running for 67 days without a single stop. I think that is as good as we can get in any steam plant. We have motors driving a street-railway load, and we run that very often thirty or sixty days; we sometimes get a sudden knock-out, but are back in five minutes. If they are out over half-an-hour we hear from the board of directors.

I will illustrate what we did about two weeks ago. The station at Electra entirely broke down. There was a load all along its line which made it necessary to carry everything from the other stations. The intermediate station was partly disabled. That makes a distance of 325 miles the line was put through. We started up one machine at the end, and ran it as a synchronous motor and varied its excitation, and the entire load was carried, one portion to a mine; making a total of 350 miles of stretch. The service was just as good as when we were feeding from both ends, due to the fact that we had the synchronous voltage running at the terminal and we held the voltage just as though we had the power house there.

MR. BLACKWELL: I would like to ask Mr. Baum whether all the different plants of the California Gas and Electric Corporation are ordinarily operated in parallel; or whether they each supply a different portion of the system, and are only thrown in parallel to meet emergencies?

Prof. BAUM: Just at present we are not operating them in parallel. We intend to arrange, in the course of time, so that we can at any time parallel them. They are arranged now so that you can pass a load from one point to the other. The two systems are kept separate at present so that the services from one line will not affect the service on the other. But we may change that. I anticipate when we get some insulators replaced, which we are now doing, that we will not have an interruption once in two or three months, with the modern insulators, and in that case we might as well tie the whole thing together.

MR. T. J. CREAGHEAD: I would like to ask Professor Baum about the line switch as shown on page 52. I have not dealt with the fifty and sixty thousand volt lines but on medium high-tension transmission lines. I have always had the greatest respect for any place up the pole anywhere near the cross-arm. Now, in the use of a line switch as indicated

by Professor Baum, I would like to know whether it is the intent to climb the pole and turn the switch by hand.

Prof. BAUM: The switch is operated from the ground with a single lever. The three switches are connected here with a wooden cross-bar and they are operated from the ground with a lever.

Mr. P. H. THOMAS: I wish to ask the author for a point of information. As I understand his calculation, the possible voltage rise on a line due to the interruption of a short-circuit current is made as follows: The heavy current resulting from the short-circuit stores magnetically in the inductance of the line a considerable amount of energy. On interrupting this current, this energy, is discharged into the capacity of the line. The result is a certain rise of potential, depending on the inductance of the line, the resistance and capacity and some other factors. The numerical value of this equation is based upon the assumption that the interruption of current occurs near its maximum value. What I wish to ask, is whether any experimental evidence has been derived tending to show that actual interruption of current does occur near the maximum point? I wish to call attention to the distinction between the mathematical basis of the equation stated and the rise of potential which may occur due to a resonant circuit tuned to an oscillating source of electromotive force, the latter requiring evidently a number of alternations to establish maximum potential. As far as my observation and experience are concerned, which include a number of direct experiments, no positive evidence is obtained proving that a heavy current will actually be interrupted near its maximum point within the wave.

Prof. BAUM: Mr. Thomas has got the wrong impression from the article. The rise in voltage is two hundred times the interrupted current, as I said. Take the value of the current the moment you interrupt it, and you get the rise in voltage. If you have no current, you have no rise. In other words, the current is sinusoidal. If you interrupt it at the zero line, we don't get any rise in voltage. If we interrupt it at the crest, the maximum, we have the maximum disturbance. I do not think we have any more evidence that the current will be interrupted at the crest than we have that it will be interrupted at any other point. If you throw a wire over that line, you do not know whether the final burning out is going to be at one point of the current wave more than another.

DR. PERRINE: I think the real thing Mr. Thomas is trying to get at is, whether there is any direct evidence that there is any considerable rise in potential?

MR. THOMAS: That is the point exactly.

Prof. BAUM: When we performed these experiments by short-circuiting this line a hundred miles away, we short-circuited the switch, an oil switch; the line discharged over an arrester set for  $4\frac{1}{2}$  inches. You can readily calculate your voltage in order to jump that air gap; about 90,000 volts;  $4\frac{1}{2}$  inches to ground, 9 inches between lines; short-circuit to ground. That occurred repeatedly.

MR. THOMAS: At which end did that discharge occur?

Prof. BAUM: It occurred at the power house. It would undoubtedly



have occurred elsewhere if we had other lightning arresters. It occurred at the power house because that is where we had lightning arresters. It was an oil-break switch.

MR. THOMAS: What do you conclude from that?

Prof. BAUM: I conclude from that that you get a rise in voltage somewhere approximating that formula, due to an interruption, a short-circuit.

DR. PERRINE: I think there is an unfortunate double meaning to the term "resonance" as employed in the discussion. Mr. Baum is using resonance to signify the discharge due to a resonant circuit, a circuit which may not be perfectly balanced against another circuit but which at the same time is a circuit which discharges because it has inductance and capacity in it and in which the current circulating is interrupted. What Mr. Baum is giving us is what actually occurs when we interrupt a definite circuit. What Mr. Thomas described is what might occur, if we had one circuit perfectly balanced against another circuit. If this were impressed with the same frequency and voltage that are used in Mr. Baum's calculations, it would result in a very much higher increase of potential.

MR. THOMAS: The information I desire is, which is the actual explanation of our troubles?

Prof. BAUM: I think that is given here.

MR. THOMAS: I was asking what the evidence was for that; that was the point I was starting out; and if that is clear then I am through. What is the evidence of that? You assume it is so?

Prof. BAUM: There is nothing theoretical that can be shown, but I have never heard the thing questioned before.

DR. BELL: As a matter of fact, when we have a circuit such as Professor Baum has indicated we have a perfectly straightforward clear case of simple resonance in a simple circuit and under those circumstances we get that rise. You can call it by any name you please. It is simply one form of resonance. The last speaker was referring to what you might call complex resonance, which I believe actually does take place on lines oftener than we think.

MR. NEALL: I wish to add to Dr. Bell's remarks that I do not wish to criticise Professor Baum for his lightning arrester, but to call attention to the importance of the lightning arrester situation in general. Abroad, where the horn-type arrester has been used very generally, there seems to be no data to show its efficiency at 50,000 volts. This system of protection has not until recently met with favor in this country, and its present employment, which is confined to very high voltages, indicates a degree of protection lacking in our regular types. For this reason we can appreciate the desirability of all possible information as to the operation of Professor Baum's 50,000-volt horn-type arrester. My question has for its object more to learn what happened to these arresters than to criticise any individual for installing them. In continuation of my series of questions, I should like to ask Professor Baum if he has lost any poles directly from lightning.

Prof. BAUM: I do not think we have lost any poles due to light-

ning. We may have lost an insulator here and there, but I cannot trace and absolutely prove a single thing on our lines due to lightning.

MR. NEALL: Don't you think you could have taken a record of the operation of your arresters wherever they have been installed, by putting in supplementary gaps and having your men watch them regularly, thus knowing very closely what your arresters were doing and when they did it?

Prof. BAUM: Of course, we try to get all the information we can from our system. You are no more eager for information than we are. We do not get the information primarily to present to a meeting of this kind. We get it primarily for ourselves.

MR. NEALL: I do not want to appear prejudiced, but it does seem to me that the usefulness of the horn-type arrester has not been brought out prominently. The only thing that has been brought out is that it does not do any harm to the system, but there is a very grave question whether it does any good.

Prof. BAUM: Well, I consider it a safety. It may not operate more than once in a year, may not operate more than once in two years, but even if it shuts down your system once in two years absolutely, I consider it a safety to the system.

MR. NEALL: Do you think it is any better in that respect than other forms of arresters which will discharge at lower voltage?

Prof. BAUM: The trouble is that they discharge too often. We do not want them to discharge that way. When they discharge once they are entirely out of business; you have got to buy a new set, and you know how many there are in multiple; it is expensive to put in lightning arresters of the ordinary type. Here we just put up a lot of copper wire and there is the end of it. We could keep one freight car from the East loaded with lightning arresters of the ordinary type busy all the time. Of this kind we can buy ordinary copper wire in stock and put it up.

MR. NEALL: Is that a matter of experience or just a matter of belief?

Prof. BAUM: That is experience. I have had lightning arresters out there by the hundreds.

MR. NEALL: Have you tried all types of arresters?

Prof. BAUM: All types that we could get hold of.

MR. NEALL: Then I am to infer from your remarks that you believe for the future protection of high-voltage lines that some simple form of horn arrester is the solution?

Prof. BAUM: I don't profess to have any particular prophetic vision in the matter at all. At present we are using the horn arrester. As far as I am concerned I would just as soon take them all off; but I keep them there for safety.

MR. MORAN: I have had no experience with the horn arresters and have had some with the multiple-gap arrester; a test of forty thousand volts did not prove satisfactory to the multiple-gap arrester. If you will notice 30,000-volt lightning arresters in working condition, closed upon the line there will be seen a number of sparks constantly plying between the gap half way down the arrester, and as the surges in the line increase they

will go to ground, opening the circuit if you have any automatic arrangement in the line, so that Mr. Baum's answers indicate to me that 30,000 volts is the limit for such arresters.

Mr. GERRY: Mr. Baum remarked that the limit of transmission tension rested with the insulator. I think it does not rest with the insulator, but with the transformers and secondary apparatus, such as the lightning arresters, switches, etc. Many of the difficulties have been worked out by Mr. Baum, and he has shown that we may go with safety to somewhat higher pressures, but it seems to me that the limiting condition is still in the apparatus even more than in the line insulation. The horn type of arrester will undoubtedly do good work under certain conditions, but as Mr. Baum will concede, if the gap be adjusted so that it will discharge only occasionally, a number of small difficulties such as occur with multiple-gap arresters, will be overcome but they will then be concentrated in one considerable difficulty, perhaps an interruption of the service, which may occur but once a month or once a year, depending upon the climatic conditions. In regions where there is a great deal of lightning it may readily be seen that a horn arrester might produce most unsatisfactory results, in the way of frequent shut-downs, while in other localities the results from a practical standpoint might be acceptable. I brought up the lightning arrester question, not because I disagreed with Mr. Baum, but to bring out the facts, and having done this I wish simply to reiterate the statement that I believe the limitations of working pressure for transmission purposes to be in the lightning arresters, switches, and secondary apparatus, as well as in the transformers. These limitations are not permanent, and the difficulties they present will be overcome, but at the present time the limiting conditions are there rather than in the line insulation.

Prof. BAUM: I do not agree with Mr. Gerry on most of those points. The transformers are not limited to the present voltages for which they are now being built. We are willing to build oil switches for 100,000 volts if we want them. The lightning arrester I think will take care of itself when you are operating at 100,000 volts and over; that is, if you insulate the line properly. There is nothing left, in my mind, but the line insulator, and I consider that the weak point of the transmission—the only one at which we see any very great difficulty in going to a higher voltage, say 100,000 volts. In other words, I believe if it were not for the line insulator we could go to 100,000 volts to-day.

Chairman SCOTT: We have had a very interesting discussion on the matter of lightning arresters, even though it be but an incidental part of the paper. I fear that some of the things Mr. Baum has said are susceptible of misinterpretation by others. If the simple statement goes forth that in operating his line he has found the simple horn arrester to be ample, and since his lines constitute the most extensive system in existence, then others may conclude, that because their lines are shorter and voltage lower, the horn arrester will be ample for them. I do not believe Prof. Baum quite intends that interpretation. In fact, he has said that he has but little lightning, and that he would not regret very much leaving them off entirely, but it was rather a matter of conscience

and sentiment that the arresters were put on, so that they might feel a little safer. The absence of severe lightning is shown by the fact that they have lost no poles by lightning. On another plant a gentleman told me a while ago that in one storm forty-seven consecutive poles were more or less affected, and that he had had large poles from which, after one good disturbance, there wasn't enough left to make a fence post. Now Prof. Baum is not talking about conditions of that kind. He has said, moreover, that something happens on the lines from time to time, and he does not know whether it is caused by the lightning arrester or not; and he suggests that these disturbances, due to lightning arresters or something else, may be eliminated so that they occur only occasionally. Perhaps in the large system there is less likelihood of shutting down due to a disturbance at one place; but there are plants in which the mere fact of a temporary shut-down once or twice a season, of perhaps only a few minutes, and involving little or nothing in the way of cost and repairs, would lead to a very grave criticism of the protective devices. So I think, in line with what Mr. Gerry has said, we must feel that the lightning arrester problem is not at all solved because there have not been more difficulties on the Bay Counties line. If the operating engineers are satisfied with a horn arrester; if that will do all that they want, the manufacturers of lightning arresters have been entirely off the track in spending thousands of dollars and the time of experts in trying to solve the problem. Some may say it is because they want to sell something; but primarily it is because of the fundamental need of something of that kind, and because they have felt there is such a need. In fact I rather think that some of those who manufacture lightning arresters would possibly be glad to be relieved of the whole problem, but it is a necessary element, and one of the most difficult in the preparation of the apparatus for transmission systems, and I rather feel that operating engineers do not want to express a sentiment which will lead to the idea that efforts in this line by those who are doing the work of investigation, and trying to prepare apparatus of this kind should be lessened. Do I state it properly, Prof. Baum?

Prof. BAUM: That is correct. I do not want to give out the impression that if I were operating in a different part of the country and I were operating at a different voltage that I would not put on the multiple-gap lightning arrester.

Chairman SCOTT: Probably put on everything you could get?

Prof. BAUM: Tried everything I could get. We have tried this here and it has gone out of service and we have tried something else.

## AMERICAN PRACTICE IN HIGH-TENSION LINE CONSTRUCTION AND OPERATION.

---

BY DR. F. A. C. PERRINE, *Delegate of the National Electric Light Association and of the Pacific Coast Transmission Association.*

---

A characteristic of American practice is that it tends toward standards not only in the matter of the sizes of units, speeds and manufacture appearance, but also in the methods of producing results and in types of engineering. While it may be true that this tendency was originally based upon a desire for cheap manufacture and interchangeability of parts, at the same time it must be understood that the present elaboration of this policy is somewhat due to the fact that in so large a country the ideas of the best men cannot be directly applied except as they may be adopted for standards. No one section of the country produces the best men necessarily, nor does any one group of engineers dominate our practice. On the contrary, the meetings of our engineering societies have taken the character of sittings of committees, where are presented many plans, and where all plans are carefully discussed and sifted. From those presented the best is chosen and becomes the standard.

Accepting these results as the standard does not imply that there is general in this country a spirit of copying or of servile imitation among the engineers. On the contrary, we feel that the result of the attitude so prevalent in American engineering at the present time, of establishing standards, has introduced a wise spirit of conservatism, and has thrown the burden of proof upon each one presenting a new idea. At the same time it has resulted in raising the character of the average engineering work throughout the country, until today good American engineering can be found, not only in the great spectacular plants near enough to the large centers of progress to have the personal attention of the most experienced engineers, but in consequence of this system of practice an equally good type of engineering can be found in the plants in the out-of-the-way deserts or mountain regions, where

the local engineer of good capacity, knowing his conditions thoroughly, has relied upon the standards established by his fellows in those particulars where his own experience has been limited, and in consequence a plant is produced, not only more perfectly adapted to the particular circumstances of its surroundings, but in all details more thoroughly satisfactory than could have been designed under any other system. Our rule is that invariably one should adhere to well-established practice and introduce such modifications as are made necessary by the local conditions. This does not limit the full employment of the energies and brains of the local engineer, since, without a special consideration of outside details, there is always in every transmission plant particular circumstances which tax the ingenuity of the best. That this is the general method of American practice will be seen by any one who consults the report of the standardizing committee of the American Institute of Electrical Engineers. The report covers, not only units, standard methods of testing, and details of manufacture, but also procedure, both outdoor and in, for all types of plants, and this report in itself has resulted in a certain similarity of type where problems to be solved are similar.

The work of the transmission engineer lies in fields so essentially dissimilar that even in spite of this general tendency it may be difficult at first view to ascertain what is the American practice in work of this class. On closer examination one finds, however, this work falling into natural groups dependent on the length of transmission and the voltage employed, though what has been done has been materially modified by the date of erection, since during the past ten years modifications in the arts have been necessarily reflected in the types of construction.

The general groups have been somewhat decided by the manufacturers of machinery, who have presented as preferable certain available voltages. Above 2400 volts, where transmission proper really begins, the first voltage now commonly employed is 6600, which figure has been established as standard by the needs of the lighting plants in the great cities, and has been adopted by the transmission companies in place of either a higher or lower voltage mainly because it is a standard. For this voltage direct generation at high pressure is almost invariably used. The next higher voltage now commonly employed, and practically the first one for which step-up transformers are used, is 15,000. During the past few years this has taken the place of transmissions at

10,000, 12,000 and 13,000, and it is today the established voltage for high-tension electric railways, the general reason for its establishment as a standard being that this voltage is not more difficult to handle, as regards insulation or switching, than the three last-mentioned lower voltages, and, furthermore, that, where the lower voltages have been previously established, the sphere of operation of the transmission plant has been found to be rather too much limited. There are in the Rocky Mountain region and west a great number of the older plants operating at 10,000 volts, and whenever direct high-voltage generation has been attempted, voltages of from 12,000 to 13,000 volts are used; but, at the same time, the majority of the plants which have used these lower pressures in the past today have circuits with special transformers operating at the higher figure. The next step is to 25,000 volts, which is the highest figure reached without special study of insulators, switches and lightning arresters. This voltage has been successfully handled without serious trouble during the past six years. A voltage of 33,000 is employed in a number of plants built about five years ago, and at this figure the special difficulties due to line capacity, insulator size, erratic lightning-arrester effects and switching begin to make themselves seriously felt. Above 33,000 volts the standard voltage is called 60,000, although in all plants that have heretofore been established to operate at this pressure, there have been installed transformers arranged for connection to various voltages of from 40,000 up to 60,000 volts, and the majority of these plants are today operating at about 50,000 volts, some of them being unable to operate at the highest pressure on account of the character of line insulators originally installed. In the choice of voltage for any transmission it is considered the best practice to establish it at the rate of 1000 volts per mile, provided the length of transmission be not above 60 miles, since above 60,000 volts no commercial work has been regularly attempted. In the table recently presented by the transmission committee of the American Institute of Electrical Engineers, the highest average voltage per mile for any one class in their report is 840; but in examining this table it must be remembered that their correspondents have reported the total length of line in service, so that, if a plant be operating two lines fifteen miles each in length at 15,000 volts, the table would indicate an operation at 500 volts per mile, although for each line the transmission was at 1000 volts per mile.

The common lighting frequencies of 125 and 133 have, for transmission lines, given place entirely to the frequencies of 60-40-30 and 25, no use having been made in this country of the frequency of 100, and only in one locality has there been any employment of 50 periods.

In the transformation from one frequency to another, which is found often to be advantageous, simple apparatus would be employed if the frequencies in use were multiples of each other and use made of 25-50 and 100 or of 30-60 and 120, but, unfortunately, the four frequencies mentioned have been practically used and are to-day too thoroughly established for further change.

Systems in which lighting is the principle element, and where distribution over a wide territory make the work of small communities an important element to the business office, employ a frequency of 60 periods per second and at this frequency large amounts of energy is transmitted to considerable distances at the highest voltages. The frequency of 40 is largely confined to transmissions from which cotton mills are operated, this having resulted in motor speeds suitable to their line shafting.

For a number of years the two frequencies of 30 and 25 have contested for supremacy in plants primarily established for power purposes and for the operation of rotary converters, but largely on account of the very great amount of machinery installed at Niagara and employing a frequency of 25 that is becoming more and more to be the established standard for power purposes and seems likely to displace altogether the higher, which has no distinct superiority except that it is one-half the standard frequency used in lighting.

In the generation of power the revolving-armature machine has almost disappeared from the new plants, and revolving-field generators have become so settled in type that those produced by different manufacturers are hardly distinguishable by the casual observer. For the low-head plants using turbine wheels it is necessary to provide for a 50 per cent increase of speed, and in the high-head plants, where impulse wheels are employed, a strength sufficient to withstand a speed increase of 100 per cent must be allowed to provide against damage from overspeeding should the power be thrown off and the water continue to flow. The machine fulfilling these conditions and practically adopted by all the manufacturers is characteristically a revolving field machine with the poles keyed to a cast-steel spider, the field windings being of copper strip wound upon edge, the armature



being constructed of a cast-iron box girder supporting the stationary armature laminations. Almost the only departure from this type of construction for power-transmission work is found in the balanced type of inductor machine, where the field is magnetized by a central stationary field coil wound with copper strip, the armature in two halves symmetrically arranged around the central core being of laminations supported either by cast-iron rings connected together by cold-rolled steel bars or supported by a steel shell to which the armature laminations are keyed.

Various station voltages have been employed, but, where direct generation at 6600 or 12,000 volts has not been resorted to, the practice is setting more and more to the use of about 2300 volts, this being chosen because the lower voltages require large extra station copper and the higher voltages are felt to introduce unnecessary station difficulties of insulation and switching. For switching, the present type of 2300-volt oil switch has been so well developed, by reason of the great number of plants operating at this pressure, that for handling a particular amount of energy it is both cheaper and better than any 500-volt switch on the market.

For plants operating at less than 25,000 volts, the step-up transformers in use are about equally divided between the water-cooled, oil-filled types and air-blast types. Where a good supply of water is to be readily obtained, the oil-filled transformers have generally been given preference, as they can be more readily adjusted for a varying flow of water at different loads. The question of the relative fire risk from the two types has been extensively discussed, and it can hardly be said that any very definite conclusion has been finally reached, though the weight of opinion seems by far to be that the fire risk is at least not increased by the use of the oil-filled transformer, and the actual risk in either type seems to be a matter largely of installation. It is perfectly true that there have been some very serious fires, resulting in the complete destruction of power plants, where oil-filled transformers have been used, but in each case the fire has started outside of the transformers, though they themselves, by reason of being installed without reference to safety in case of fire, have furnished fuel which has augmented the conflagration. Today the conditions of installation for safety are better understood, and it now only remains to be decided whether, in the case of a fire actually arising, the oil shall be run out and the transformer cases filled

with water, or the whole transformer protected, either by running an excessive amount of water through their cooling coils, or by so installing them that the transformers may temporarily be submerged to within a few inches of their tops. Actual protection of transformers by running water through their cooling coils has been found to be effective in at least one serious fire.

For high-tension switching, use has been made of a long arc broken between carbon terminals, long-inclosed fuse, a fuse drawn through a tube filled with a fine, non-conducting powder, and of oil switches. The first two types, while interrupting the circuit well, draw an arc of excessive length and produce a surging which may result in an increased potential of at least as much as 50 per cent. In consequence, these types are rapidly disappearing except in plants operating at 15,000 volts and below, where the carbon break is preferred to the inclosed fuse, though it is common to install the two in series, allowing the fuse to operate as a safety device, but not for the purpose of switching. The type of switch where a wire is drawn through a tube filled with powder is found to operate successfully up to 40,000 volts and without serious surging on the circuit, but the powder being blown out with great force, scatters over the entire station, and is in consequence not allowable. The oil switches mainly employed are those with the vertical break and those with the horizontal break. The vertical-break switch has the advantage that the amount of oil contained in the oil-tank is relatively small, and will add to possible conflagration only a slight amount of fuel. This switch is found on severe short-circuits often to blow all the oil out of the tank unless the tank is built very strongly, when it becomes necessary to insulate the plunger from the tank as it enters the switch. The horizontal-break switch, while containing a large amount of oil, will for the same length of break, handle about 25 per cent more energy at any definite potential. This switch can successfully be used at 60,000 volts, and up to the present time has not been found to blow the oil from the tank. These two types of oil-switch are the standard today, no distinct preference being given to the horizontal switch, though the writer believes that in the future this type will be used as a standard for the highest potentials.

Transmission with two-phase connection of circuits, whether using three or four wires, has for voltages above 6600 given place entirely to transmission with a three-phase connection,

though three-phase transmission with two-phase distribution described by Mr. Scott at the International Congress of 1893 is very extensively employed.

The relative merits of the delta and star connection of the lines to the transformers is still somewhat in dispute, so much so that in plants of the highest voltage, where several voltages are provided, certain of the lower voltages are obtained by delta connections to the transformers, while the higher voltages are to be obtained by a star connection. In general it may be stated that up to 25,000 volts the delta connection is generally preferred, principally because with this connection a ground upon one line does not necessarily result in a short-circuit, and, furthermore, the service is not necessarily interrupted in the case of the failure of a single transformer. At voltages higher than 25,000 volts the transformers for delta connection become more difficult to build and insulate. Furthermore, a single ground anywhere produces disturbances of a serious character, and in consequence the star connection with the grounded neutral is employed, advantage being taken of the fact that a grounded neutral aids in the distribution of unbalanced loads, and furthermore the rise of pressure which may occur from line discharge at the time of an open-circuit or a short-circuit are not so likely to produce serious results.

For the distribution of current through the low-tension mains, it is generally the custom to transform to 2300 volts two-phase unless either the load is mainly one of motors, or unless there are important motors of considerable size to be supplied at a distance of half a mile or more from the sub-station. In such cases three-phase star-connected four-wire distribution is employed, allowing the connection of distributing devices either to a 2300-volt circuit between lines and the neutral wire, or a connection to a 4000-volt delta circuit for balanced loads. This combination of circuits is found to be extremely useful where a mixed load is to be supplied at varying distances.

The high-tension lines themselves are preferably run over private right of way. Railroad rights of way were at first highly prized on account of the entire absence of trees and disturbing structures, and furthermore on account of the fact that inspection and repairs are most easily provided for; but experience with such lines has proven that, for transmissions at even so low a tension as 15,000 volts, the interference with insulation by the smoke from the locomotives, which covers the insulators, more than

counterbalances all the advantages, and today such rights of way are more commonly shunned than sought. Where railroad locomotive smoke combined with sea fog is encountered, it becomes absolutely necessary to clean each insulator at frequent periods, even though the voltage of transmission be not more than 5000 or 10,000. Along the country road this difficulty is not apparent, but in some localities farm structures and trees interfere with the transmission, so that in general it may be said that a private right of way that the transmission company can absolutely control is much to be preferred.

In the most recent types of construction the height of pole is limited as much as possible. While there may be some increased security from malicious disturbance in the use of high poles and a decrease of line capacity may be expected, these advantages are only obtained at the expense of stability and at an increased cost. A pole 35 ft. long set 5 ft. in the ground permits the safe installation of either a single three-phase line with a spread of as much as 6 ft. by supporting one insulator on the top of the pole and the other two on the ends of a long cross-arm; or it may be used to support two three-phase circuits on opposite sides of the pole with a spread between wires of 3 ft. by the use of two cross-arms, and at the same time such a pole permits the safe installation of telephone or other signaling circuits on brackets or cross-arms at a safe distance below the power lines. These poles should not be less than 8 in. in diameter at the top and not less than 12 in. in diameter at the ground line. Variations from these dimensions may be considered as being due to special considerations based upon the location of the lines or arrangement of the circuits. It is true that such a standard pole may only be arrived at after a consideration of the wind stresses on the particular lines taken in conjunction with the spacing of the poles, but as the maximum pole spacing on transmission lines is about 135 ft., at average wind velocities these pole dimensions may be considered safe. Extra strength required by variations of wind stress, either due to an increase in the number of wires or to a necessity for allowance for sleet, is more commonly taken care of by shortening the spans than by an increase in the size of the pole. In some cases where severe sleet conditions are to be encountered and the wires are large, it is the practice to install these poles at not more than 50 ft. apart.

The material used for poles depends largely on the locality.

In the Southeastern States chestnut is the favorite wood; along the Canadian border and through the Rocky Mountain regions cedar is employed, while square-sawn redwood is used almost exclusively on the Pacific Coast. With increase in voltages and consequent increased trouble from insulators, a demand has arisen for a pole-line construction which will permit a decrease in the number of insulators and allow an increase in the size of each. This has been accomplished by the use of galvanized-iron towers not less than 40 ft. from the ground-line to the wires, and spaced about 500 ft. apart. One plant in Mexico has recently successfully installed this method of construction. A second in the same country has contracted for its material, and a number of plants in the United States are contemplating its use. The question of the life of wooden poles depends not only upon the character of the wood and its condition when cut, but also upon the local conditions of atmosphere and soil. In some places the poles which are available have no longer life than about five years, and, in the extreme, wooden poles cannot be greatly depended upon for a period greater than 15 years, though the redwood poles installed along the lines of the transcontinental railroads west of the Rocky Mountains have in many instances given a life up to 35 years, and are still said to be in good condition; but these poles are set into a soil strongly impregnated with alkali in a country where rains are few and the air generally dry. Nothing is known as yet of the life of the galvanized-iron tower except from windmill practice, where towers which have been galvanized after all punching and machining is done are found to be in good condition after a period of 10 to 15 years.

The cross-arms in use are almost invariably made of pine without treatment other than painting. These arms are let into the pole from 1 to 2 in., being held by bolts through the pole and arm, and when long are additionally supported by braces. Even with steel poles wooden arms are used, the general feeling being that there is less probability of the circuit being completely disabled should an insulator break and the line fall, if it falls upon a wooden rather than a steel arm. At the same time an experiment in the use of wooden braces has not been found to result in any certain advantage. In consequence, flat galvanized-iron braces established a number of years ago as standard by the telegraph and telephone companies are now almost universally employed in the construction of transmission lines. With increase in spans and

voltages the insulators are increasing in size. This condition will probably in the future demand a strength of arm greater than can be obtained by the use of wood. This problem, however, has not as yet obtained a definite solution.

For plants operating below 25,000 volts much use has been made of glass as a material for insulators. Glass has been for many years the standard insulator material in American telegraph and telephone practice, and in spite of many experiments that have been tried with porcelain, it is still considered the best and cheapest material for this service. However, in transmission work one of the great advantages claimed for glass in telephone and telegraph practice disappears. The engineers of these companies claim that it is important to provide against dark, narrow spaces within the insulators on account of the fact that they form the homes of insects. The transparency of the glass largely obviates this difficulty. Where large insulators are used such as are employed by transmission companies, the spaces within the insulators are well lighted from below, and the transparency of the material is not important. Glass is comparatively fragile, and for transmission work it has nothing to recommend it except low first cost and cheap inspection; these, to be sure, are very often overpowering advantages when the voltage is low enough for the particular form of insulator used to provide a large factor of safety, and in consequence up to 15,000 volts glass insulators are generally preferred unless there are special climatic conditions which render them liable to fracture. Many series of tests have shown conclusively that the porcelain insulator has a greater mechanical strength, is less liable to surface leakage, has a safe dielectric strength, and in addition that it is exceedingly difficult to break the head of a porcelain insulator so as to allow the wire to fall away from it. The one disadvantage of porcelain is that there is an uncertainty as to its solidity, and that it is only possible to ascertain its solidity by most careful high-voltage tests. The question of the form of high-voltage insulator as yet is in high dispute, operating engineers being inclined to a design where the petticoats are very long and comparatively close together, so that great creeping distance be given over the surface of the insulator between line and line and between line and pin, comparatively little importance being placed on the flashing distance. Engineers of the manufacturing companies, however, incline toward one of a much more open type of large diameter and with few petticoats.

This latter form undoubtedly gives the greatest sparking distance, has the least dark spaces within it, and is more readily cleaned by rain storms. It is also important that such an insulator may be constructed to operate at high voltage without noise, and, as there is a definite loss of energy whenever the insulators on a line are noisy, it may be safely predicted that the open type of insulator is to be the one that will be in the future considered as the standard.

While, for a particular voltage, insulator size may be largely determined by the form, at the same time we may in general note that up to 10,000 volts insulators, whether of glass or porcelain, have a minimum diameter of about 5 ins. A 7-in. insulator can successfully be used on voltages as high as 25,000, a 13-in. insulator is sufficient up to 40,000 volts, while at 60,000 volts it does not seem safe to install insulators having less diameter at the top than 14 ins. A greater size would unquestionably invariably be used for these high voltages if the problems of the manufacture of porcelain and support of the insulator were altogether solved.

Insulators above eight inches in diameter are generally manufactured in several parts and either glazed together in the porcelain kiln or cemented together in the field. This method of construction allows a more thorough inspection of the constituent parts for solidity of material and also reduces the loss from breakage in transit. It has the disadvantage of introducing into the insulator a variable dielectric which, however, in line insulators has not been proven to be a disadvantage.

Attempts have been made to construct an insulator of two materials, such as glass and porcelain, but all such attempts have been now abandoned and the separable insulator is now constructed entirely of porcelain united with Portland cement.

In supporting the insulators on cross-arms it is necessary to provide that the lowest petticoat be raised above the cross-arm as much as the radius of the insulator, and, as the strain comes on the extreme top of the pin, it is obviously difficult to successfully support the largest size of insulators by means of the common pin and cross-arm construction. By using carefully selected woods, this has been successfully accomplished for insulators up to 11 ins. in diameter, but at 40,000 volts in bad weather such insulators carry enough current over their surface to char a wooden pin. Accordingly practice has settled to the use of iron pins in plants operating above 25,000 volts. At this voltage and below, the wooden pin can be

voltages the insulators are increasing in size. This condition will probably in the future demand a strength of arm greater than can be obtained by the use of wood. This problem, however, has not as yet obtained a definite solution.

For plants operating below 25,000 volts much use has been made of glass as a material for insulators. Glass has been for many years the standard insulator material in American telegraph and telephone practice, and in spite of many experiments that have been tried with porcelain, it is still considered the best and cheapest material for this service. However, in transmission work one of the great advantages claimed for glass in telephone and telegraph practice disappears. The engineers of these companies claim that it is important to provide against dark, narrow spaces within the insulators on account of the fact that they form the homes of insects. The transparency of the glass largely obviates this difficulty. Where large insulators are used such as are employed by transmission companies, the spaces within the insulators are well lighted from below, and the transparency of the material is not important. Glass is comparatively fragile, and for transmission work it has nothing to recommend it except low first cost and cheap inspection: these, to be sure, are very often overpowering advantages when the voltage is low enough for the particular form of insulator used to provide a large factor of safety, and in consequence up to 15,000 volts glass insulators are generally preferred unless there are special climatic conditions which render them liable to fracture. Many series of tests have shown conclusively that the porcelain insulator has a greater mechanical strength, is less liable to surface leakage, has a safe dielectric strength, and in addition that it is exceedingly difficult to break the head of a porcelain insulator so as to allow the wire to fall away from it. The one disadvantage of porcelain is that there is an uncertainty as to its solidity, and that it is only possible to ascertain its solidity by most careful high-voltage tests. The question of the form of high-voltage insulator as yet is in high dispute, operating engineers being inclined to a design where the petticoats are very long and comparatively close together, so that great creeping distance be given over the surface of the insulator between line and line and between line and pin, comparatively little importance being placed on the flashing distance. Engineers of the manufacturing companies, however, incline toward one of a much more open type of large diameter and with few petticoats.



This latter form undoubtedly gives the greatest sparking distance, has the least dark spaces within it, and is more readily cleaned by rain storms. It is also important that such an insulator may be constructed to operate at high voltage without noise, and, as there is a definite loss of energy whenever the insulators on a line are noisy, it may be safely predicted that the open type of insulator is to be the one that will be in the future considered as the standard.

While, for a particular voltage, insulator size may be largely determined by the form, at the same time we may in general note that up to 10,000 volts insulators, whether of glass or porcelain, have a minimum diameter of about 5 ins. A 7-in. insulator can successfully be used on voltages as high as 25,000, a 13-in. insulator is sufficient up to 40,000 volts, while at 60,000 volts it does not seem safe to install insulators having less diameter at the top than 14 ins. A greater size would unquestionably invariably be used for these high voltages if the problems of the manufacture of porcelain and support of the insulator were altogether solved.

Insulators above eight inches in diameter are generally manufactured in several parts and either glazed together in the porcelain kiln or cemented together in the field. This method of construction allows a more thorough inspection of the constituent parts for solidity of material and also reduces the loss from breakage in transit. It has the disadvantage of introducing into the insulator a variable dielectric which, however, in line insulators has not been proven to be a disadvantage.

Attempts have been made to construct an insulator of two materials, such as glass and porcelain, but all such attempts have been now abandoned and the separable insulator is now constructed entirely of porcelain united with Portland cement.

In supporting the insulators on cross-arms it is necessary to provide that the lowest petticoat be raised above the cross-arm as much as the radius of the insulator, and, as the strain comes on the extreme top of the pin, it is obviously difficult to successfully support the largest size of insulators by means of the common pin and cross-arm construction. By using carefully selected woods, this has been successfully accomplished for insulators up to 11 ins. in diameter, but at 40,000 volts in bad weather such insulators carry enough current over their surface to char a wooden pin. Accordingly practice has settled to the use of iron pins in plants operating above 25,000 volts. At this voltage and below, the wooden pin can be

voltages the insulators are increasing in size. This condition will probably in the future demand a strength of arm greater than can be obtained by the use of wood. This problem, however, has not as yet obtained a definite solution.

For plants operating below 25,000 volts much use has been made of glass as a material for insulators. Glass has been for many years the standard insulator material in American telegraph and telephone practice, and in spite of many experiments that have been tried with porcelain, it is still considered the best and cheapest material for this service. However, in transmission work one of the great advantages claimed for glass in telephone and telegraph practice disappears. The engineers of these companies claim that it is important to provide against dark, narrow spaces within the insulators on account of the fact that they form the homes of insects. The transparency of the glass largely obviates this difficulty. Where large insulators are used such as are employed by transmission companies, the spaces within the insulators are well lighted from below, and the transparency of the material is not important. Glass is comparatively fragile, and for transmission work it has nothing to recommend it except low first cost and cheap inspection; these, to be sure, are very often overpowering advantages when the voltage is low enough for the particular form of insulator used to provide a large factor of safety, and in consequence up to 15,000 volts glass insulators are generally preferred unless there are special climatic conditions which render them liable to fracture. Many series of tests have shown conclusively that the porcelain insulator has a greater mechanical strength, is less liable to surface leakage, has a safe dielectric strength, and in addition that it is exceedingly difficult to break the head of a porcelain insulator so as to allow the wire to fall away from it. The one disadvantage of porcelain is that there is an uncertainty as to its solidity, and that it is only possible to ascertain its solidity by most careful high-voltage tests. The question of the form of high-voltage insulator as yet is in high dispute, operating engineers being inclined to a design where the petticoats are very long and comparatively close together, so that great creeping distance be given over the surface of the insulator between line and line and between line and pin, comparatively little importance being placed on the flashing distance. Engineers of the manufacturing companies, however, incline toward one of a much more open type of large diameter and with few petticoats.

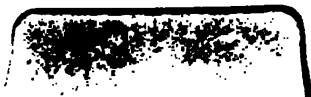

This latter form undoubtedly gives the greatest sparking distance, has the least dark spaces within it, and is more readily cleaned by rain storms. It is also important that such an insulator may be constructed to operate at high voltage without noise, and, as there is a definite loss of energy whenever the insulators on a line are noisy, it may be safely predicted that the open type of insulator is to be the one that will be in the future considered as the standard.

While, for a particular voltage, insulator size may be largely determined by the form, at the same time we may in general note that up to 10,000 volts insulators, whether of glass or porcelain, have a minimum diameter of about 5 ins. A 7-in. insulator can successfully be used on voltages as high as 25,000, a 13-in. insulator is sufficient up to 40,000 volts, while at 60,000 volts it does not seem safe to install insulators having less diameter at the top than 14 ins. A greater size would unquestionably invariably be used for these high voltages if the problems of the manufacture of porcelain and support of the insulator were altogether solved.

Insulators above eight inches in diameter are generally manufactured in several parts and either glazed together in the porcelain kiln or cemented together in the field. This method of construction allows a more thorough inspection of the constituent parts for solidity of material and also reduces the loss from breakage in transit. It has the disadvantage of introducing into the insulator a variable dielectric which, however, in line insulators has not been proven to be a disadvantage.

Attempts have been made to construct an insulator of two materials, such as glass and porcelain, but all such attempts have been now abandoned and the separable insulator is now constructed entirely of porcelain united with Portland cement.

In supporting the insulators on cross-arms it is necessary to provide that the lowest petticoat be raised above the cross-arm as much as the radius of the insulator, and, as the strain comes on the extreme top of the pin, it is obviously difficult to successfully support the largest size of insulators by means of the common pin and cross-arm construction. By using carefully selected woods, this has been successfully accomplished for insulators up to 11 ins. in diameter, but at 40,000 volts in bad weather such insulators carry enough current over their surface to char a wooden pin. Accordingly practice has settled to the use of iron pins in plants operating above 25,000 volts. At this voltage and below, the wooden pin can be

voltages the insulators are increasing in size. This condition will probably in the future demand a strength of arm greater than can be obtained by the use of wood. This problem, however, has not as yet obtained a definite solution.

For plants operating below 25,000 volts much use has been made of glass as a material for insulators. Glass has been for many years the standard insulator material in American telegraph and telephone practice, and in spite of many experiments that have been tried with porcelain, it is still considered the best and cheapest material for this service. However, in transmission work one of the great advantages claimed for glass in telephone and telegraph practice disappears. The engineers of these companies claim that it is important to provide against dark, narrow spaces within the insulators on account of the fact that they form the homes of insects. The transparency of the glass largely obviates this difficulty. Where large insulators are used such as are employed by transmission companies, the spaces within the insulators are well lighted from below, and the transparency of the material is not important. Glass is comparatively fragile, and for transmission work it has nothing to recommend it except low first cost and cheap inspection; these, to be sure, are very often overpowering advantages when the voltage is low enough for the particular form of insulator used to provide a large factor of safety, and in consequence up to 15,000 volts glass insulators are generally preferred unless there are special climatic conditions which render them liable to fracture. Many series of tests have shown conclusively that the porcelain insulator has a greater mechanical strength, is less liable to surface leakage, has a safe dielectric strength, and in addition that it is exceedingly difficult to break the head of a porcelain insulator so as to allow the wire to fall away from it. The one disadvantage of porcelain is that there is an uncertainty as to its solidity, and that it is only possible to ascertain its solidity by most careful high-voltage tests. The question of the form of high-voltage insulator as yet is in high dispute, operating engineers being inclined to a design where the petticoats are very long and comparatively close together, so that great creeping distance be given over the surface of the insulator between line and line and between line and pin, comparatively little importance being placed on the flashing distance. Engineers of the manufacturing companies, however, incline toward one of a much more open type of large diameter and with few petticoats.

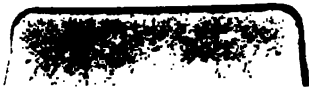

This latter form undoubtedly gives the greatest sparking distance, has the least dark spaces within it, and is more readily cleaned by rain storms. It is also important that such an insulator may be constructed to operate at high voltage without noise, and, as there is a definite loss of energy whenever the insulators on a line are noisy, it may be safely predicted that the open type of insulator is to be the one that will be in the future considered as the standard.

While, for a particular voltage, insulator size may be largely determined by the form, at the same time we may in general note that up to 10,000 volts insulators, whether of glass or porcelain, have a minimum diameter of about 5 ins. A 7-in. insulator can successfully be used on voltages as high as 25,000, a 13-in. insulator is sufficient up to 40,000 volts, while at 60,000 volts it does not seem safe to install insulators having less diameter at the top than 14 ins. A greater size would unquestionably invariably be used for these high voltages if the problems of the manufacture of porcelain and support of the insulator were altogether solved.

Insulators above eight inches in diameter are generally manufactured in several parts and either glazed together in the porcelain kiln or cemented together in the field. This method of construction allows a more thorough inspection of the constituent parts for solidity of material and also reduces the loss from breakage in transit. It has the disadvantage of introducing into the insulator a variable dielectric which, however, in line insulators has not been proven to be a disadvantage.

Attempts have been made to construct an insulator of two materials, such as glass and porcelain, but all such attempts have been now abandoned and the separable insulator is now constructed entirely of porcelain united with Portland cement.

In supporting the insulators on cross-arms it is necessary to provide that the lowest petticoat be raised above the cross-arm as much as the radius of the insulator, and, as the strain comes on the extreme top of the pin, it is obviously difficult to successfully support the largest size of insulators by means of the common pin and cross-arm construction. By using carefully selected woods, this has been successfully accomplished for insulators up to 11 ins. in diameter, but at 40,000 volts in bad weather such insulators carry enough current over their surface to char a wooden pin. Accordingly practice has settled to the use of iron pins in plants operating above 25,000 volts. At this voltage and below, the wooden pin can be

voltages the insulators are increasing in size. This condition will probably in the future demand a strength of arm greater than can be obtained by the use of wood. This problem, however, has not as yet obtained a definite solution.

For plants operating below 25,000 volts much use has been made of glass as a material for insulators. Glass has been for many years the standard insulator material in American telegraph and telephone practice, and in spite of many experiments that have been tried with porcelain, it is still considered the best and cheapest material for this service. However, in transmission work one of the great advantages claimed for glass in telephone and telegraph practice disappears. The engineers of these companies claim that it is important to provide against dark, narrow spaces within the insulators on account of the fact that they form the homes of insects. The transparency of the glass largely obviates this difficulty. Where large insulators are used such as are employed by transmission companies, the spaces within the insulators are well lighted from below, and the transparency of the material is not important. Glass is comparatively fragile, and for transmission work it has nothing to recommend it except low first cost and cheap inspection; these, to be sure, are very often overpowering advantages when the voltage is low enough for the particular form of insulator used to provide a large factor of safety, and in consequence up to 15,000 volts glass insulators are generally preferred unless there are special climatic conditions which render them liable to fracture. Many series of tests have shown conclusively that the porcelain insulator has a greater mechanical strength, is less liable to surface leakage, has a safe dielectric strength, and in addition that it is exceedingly difficult to break the head of a porcelain insulator so as to allow the wire to fall away from it. The one disadvantage of porcelain is that there is an uncertainty as to its solidity, and that it is only possible to ascertain its solidity by most careful high-voltage tests. The question of the form of high-voltage insulator as yet is in high dispute, operating engineers being inclined to a design where the petticoats are very long and comparatively close together, so that great creeping distance be given over the surface of the insulator between line and line and between line and pin, comparatively little importance being placed on the flashing distance. Engineers of the manufacturing companies, however, incline toward one of a much more open type of large diameter and with few petticoats.

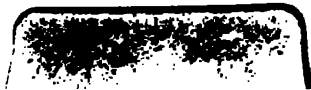

This latter form undoubtedly gives the greatest sparking distance, has the least dark spaces within it, and is more readily cleaned by rain storms. It is also important that such an insulator may be constructed to operate at high voltage without noise, and, as there is a definite loss of energy whenever the insulators on a line are noisy, it may be safely predicted that the open type of insulator is to be the one that will be in the future considered as the standard.

While, for a particular voltage, insulator size may be largely determined by the form, at the same time we may in general note that up to 10,000 volts insulators, whether of glass or porcelain, have a minimum diameter of about 5 ins. A 7-in. insulator can successfully be used on voltages as high as 25,000, a 13-in. insulator is sufficient up to 40,000 volts, while at 60,000 volts it does not seem safe to install insulators having less diameter at the top than 14 ins. A greater size would unquestionably invariably be used for these high voltages if the problems of the manufacture of porcelain and support of the insulator were altogether solved.

Insulators above eight inches in diameter are generally manufactured in several parts and either glazed together in the porcelain kiln or cemented together in the field. This method of construction allows a more thorough inspection of the constituent parts for solidity of material and also reduces the loss from breakage in transit. It has the disadvantage of introducing into the insulator a variable dielectric which, however, in line insulators has not been proven to be a disadvantage.

Attempts have been made to construct an insulator of two materials, such as glass and porcelain, but all such attempts have been now abandoned and the separable insulator is now constructed entirely of porcelain united with Portland cement.

In supporting the insulators on cross-arms it is necessary to provide that the lowest petticoat be raised above the cross-arm as much as the radius of the insulator, and, as the strain comes on the extreme top of the pin, it is obviously difficult to successfully support the largest size of insulators by means of the common pin and cross-arm construction. By using carefully selected woods, this has been successfully accomplished for insulators up to 11 ins. in diameter, but at 40,000 volts in bad weather such insulators carry enough current over their surface to char a wooden pin. Accordingly practice has settled to the use of iron pins in plants operating above 25,000 volts. At this voltage and below, the wooden pin can be

voltages the insulators are increasing in size. This condition will probably in the future demand a strength of arm greater than can be obtained by the use of wood. This problem, however, has not as yet obtained a definite solution.

For plants operating below 25,000 volts much use has been made of glass as a material for insulators. Glass has been for many years the standard insulator material in American telegraph and telephone practice, and in spite of many experiments that have been tried with porcelain, it is still considered the best and cheapest material for this service. However, in transmission work one of the great advantages claimed for glass in telephone and telegraph practice disappears. The engineers of these companies claim that it is important to provide against dark, narrow spaces within the insulators on account of the fact that they form the homes of insects. The transparency of the glass largely obviates this difficulty. Where large insulators are used such as are employed by transmission companies, the spaces within the insulators are well lighted from below, and the transparency of the material is not important. Glass is comparatively fragile, and for transmission work it has nothing to recommend it except low first cost and cheap inspection; these, to be sure, are very often overpowering advantages when the voltage is low enough for the particular form of insulator used to provide a large factor of safety, and in consequence up to 15,000 volts glass insulators are generally preferred unless there are special climatic conditions which render them liable to fracture. Many series of tests have shown conclusively that the porcelain insulator has a greater mechanical strength, is less liable to surface leakage, has a safe dielectric strength, and in addition that it is exceedingly difficult to break the head of a porcelain insulator so as to allow the wire to fall away from it. The one disadvantage of porcelain is that there is an uncertainty as to its solidity, and that it is only possible to ascertain its solidity by most careful high-voltage tests. The question of the form of high-voltage insulator as yet is in high dispute, operating engineers being inclined to a design where the petticoats are very long and comparatively close together, so that great creeping distance be given over the surface of the insulator between line and line and between line and pin, comparatively little importance being placed on the flashing distance. Engineers of the manufacturing companies, however, incline toward one of a much more open type of large diameter and with few petticoats.





This latter form undoubtedly gives the greatest sparking distance, has the least dark spaces within it, and is more readily cleaned by rain storms. It is also important that such an insulator may be constructed to operate at high voltage without noise, and, as there is a definite loss of energy whenever the insulators on a line are noisy, it may be safely predicted that the open type of insulator is to be the one that will be in the future considered as the standard.

While, for a particular voltage, insulator size may be largely determined by the form, at the same time we may in general note that up to 10,000 volts insulators, whether of glass or porcelain, have a minimum diameter of about 5 ins. A 7-in. insulator can successfully be used on voltages as high as 25,000, a 13-in. insulator is sufficient up to 40,000 volts, while at 60,000 volts it does not seem safe to install insulators having less diameter at the top than 14 ins. A greater size would unquestionably invariably be used for these high voltages if the problems of the manufacture of porcelain and support of the insulator were altogether solved.

Insulators above eight inches in diameter are generally manufactured in several parts and either glazed together in the porcelain kiln or cemented together in the field. This method of construction allows a more thorough inspection of the constituent parts for solidity of material and also reduces the loss from breakage in transit. It has the disadvantage of introducing into the insulator a variable dielectric which, however, in line insulators has not been proven to be a disadvantage.

Attempts have been made to construct an insulator of two materials, such as glass and porcelain, but all such attempts have been now abandoned and the separable insulator is now constructed entirely of porcelain united with Portland cement.

In supporting the insulators on cross-arms it is necessary to provide that the lowest petticoat be raised above the cross-arm as much as the radius of the insulator, and, as the strain comes on the extreme top of the pin, it is obviously difficult to successfully support the largest size of insulators by means of the common pin and cross-arm construction. By using carefully selected woods, this has been successfully accomplished for insulators up to 11 ins. in diameter, but at 40,000 volts in bad weather such insulators carry enough current over their surface to char a wooden pin. Accordingly practice has settled to the use of iron pins in plants operating above 25,000 volts. At this voltage and below, the wooden pin can be

voltages the insulators are increasing in size. This condition will probably in the future demand a strength of arm greater than can be obtained by the use of wood. This problem, however, has not as yet obtained a definite solution.

For plants operating below 25,000 volts much use has been made of glass as a material for insulators. Glass has been for many years the standard insulator material in American telegraph and telephone practice, and in spite of many experiments that have been tried with porcelain, it is still considered the best and cheapest material for this service. However, in transmission work one of the great advantages claimed for glass in telephone and telegraph practice disappears. The engineers of these companies claim that it is important to provide against dark, narrow spaces within the insulators on account of the fact that they form the homes of insects. The transparency of the glass largely obviates this difficulty. Where large insulators are used such as are employed by transmission companies, the spaces within the insulators are well lighted from below, and the transparency of the material is not important. Glass is comparatively fragile, and for transmission work it has nothing to recommend it except low first cost and cheap inspection; these, to be sure, are very often overpowering advantages when the voltage is low enough for the particular form of insulator used to provide a large factor of safety, and in consequence up to 15,000 volts glass insulators are generally preferred unless there are special climatic conditions which render them liable to fracture. Many series of tests have shown conclusively that the porcelain insulator has a greater mechanical strength, is less liable to surface leakage, has a safe dielectric strength, and in addition that it is exceedingly difficult to break the head of a porcelain insulator so as to allow the wire to fall away from it. The one disadvantage of porcelain is that there is an uncertainty as to its solidity, and that it is only possible to ascertain its solidity by most careful high-voltage tests. The question of the form of high-voltage insulator as yet is in high dispute, operating engineers being inclined to a design where the petticoats are very long and comparatively close together, so that great creeping distance be given over the surface of the insulator between line and line and between line and pin, comparatively little importance being placed on the flashing distance. Engineers of the manufacturing companies, however, incline toward one of a much more open type of large diameter and with few petticoats.

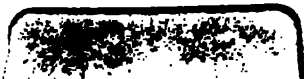

This latter form undoubtedly gives the greatest sparking distance, has the least dark spaces within it, and is more readily cleaned by rain storms. It is also important that such an insulator may be constructed to operate at high voltage without noise, and, as there is a definite loss of energy whenever the insulators on a line are noisy, it may be safely predicted that the open type of insulator is to be the one that will be in the future considered as the standard.

While, for a particular voltage, insulator size may be largely determined by the form, at the same time we may in general note that up to 10,000 volts insulators, whether of glass or porcelain, have a minimum diameter of about 5 ins. A 7-in. insulator can successfully be used on voltages as high as 25,000, a 13-in. insulator is sufficient up to 40,000 volts, while at 60,000 volts it does not seem safe to install insulators having less diameter at the top than 14 ins. A greater size would unquestionably invariably be used for these high voltages if the problems of the manufacture of porcelain and support of the insulator were altogether solved.

Insulators above eight inches in diameter are generally manufactured in several parts and either glazed together in the porcelain kiln or cemented together in the field. This method of construction allows a more thorough inspection of the constituent parts for solidity of material and also reduces the loss from breakage in transit. It has the disadvantage of introducing into the insulator a variable dielectric which, however, in line insulators has not been proven to be a disadvantage.

Attempts have been made to construct an insulator of two materials, such as glass and porcelain, but all such attempts have been now abandoned and the separable insulator is now constructed entirely of porcelain united with Portland cement.

In supporting the insulators on cross-arms it is necessary to provide that the lowest petticoat be raised above the cross-arm as much as the radius of the insulator, and, as the strain comes on the extreme top of the pin, it is obviously difficult to successfully support the largest size of insulators by means of the common pin and cross-arm construction. By using carefully selected woods, this has been successfully accomplished for insulators up to 11 ins. in diameter, but at 40,000 volts in bad weather such insulators carry enough current over their surface to char a wooden pin. Accordingly practice has settled to the use of iron pins in plants operating above 25,000 volts. At this voltage and below, the wooden pin can be

voltages the insulators are increasing in size. This condition will probably in the future demand a strength of arm greater than can be obtained by the use of wood. This problem, however, has not as yet obtained a definite solution.

For plants operating below 25,000 volts much use has been made of glass as a material for insulators. Glass has been for many years the standard insulator material in American telegraph and telephone practice, and in spite of many experiments that have been tried with porcelain, it is still considered the best and cheapest material for this service. However, in transmission work one of the great advantages claimed for glass in telephone and telegraph practice disappears. The engineers of these companies claim that it is important to provide against dark, narrow spaces within the insulators on account of the fact that they form the homes of insects. The transparency of the glass largely obviates this difficulty. Where large insulators are used such as are employed by transmission companies, the spaces within the insulators are well lighted from below, and the transparency of the material is not important. Glass is comparatively fragile, and for transmission work it has nothing to recommend it except low first cost and cheap inspection; these, to be sure, are very often overpowering advantages when the voltage is low enough for the particular form of insulator used to provide a large factor of safety, and in consequence up to 15,000 volts glass insulators are generally preferred unless there are special climatic conditions which render them liable to fracture. Many series of tests have shown conclusively that the porcelain insulator has a greater mechanical strength, is less liable to surface leakage, has a safe dielectric strength, and in addition that it is exceedingly difficult to break the head of a porcelain insulator so as to allow the wire to fall away from it. The one disadvantage of porcelain is that there is an uncertainty as to its solidity, and that it is only possible to ascertain its solidity by most careful high-voltage tests. The question of the form of high-voltage insulator as yet is in high dispute, operating engineers being inclined to a design where the petticoats are very long and comparatively close together, so that great creeping distance be given over the surface of the insulator between line and line and between line and pin, comparatively little importance being placed on the flashing distance. Engineers of the manufacturing companies, however, incline toward one of a much more open type of large diameter and with few petticoats.

This latter form undoubtedly gives the greatest sparking distance, has the least dark spaces within it, and is more readily cleaned by rain storms. It is also important that such an insulator may be constructed to operate at high voltage without noise, and, as there is a definite loss of energy whenever the insulators on a line are noisy, it may be safely predicted that the open type of insulator is to be the one that will be in the future considered as the standard.

While, for a particular voltage, insulator size may be largely determined by the form, at the same time we may in general note that up to 10,000 volts insulators, whether of glass or porcelain, have a minimum diameter of about 5 ins. A 7-in. insulator can successfully be used on voltages as high as 25,000, a 13-in. insulator is sufficient up to 40,000 volts, while at 60,000 volts it does not seem safe to install insulators having less diameter at the top than 14 ins. A greater size would unquestionably invariably be used for these high voltages if the problems of the manufacture of porcelain and support of the insulator were altogether solved.

Insulators above eight inches in diameter are generally manufactured in several parts and either glazed together in the porcelain kiln or cemented together in the field. This method of construction allows a more thorough inspection of the constituent parts for solidity of material and also reduces the loss from breakage in transit. It has the disadvantage of introducing into the insulator a variable dielectric which, however, in line insulators has not been proven to be a disadvantage.

Attempts have been made to construct an insulator of two materials, such as glass and porcelain, but all such attempts have been now abandoned and the separable insulator is now constructed entirely of porcelain united with Portland cement.

In supporting the insulators on cross-arms it is necessary to provide that the lowest petticoat be raised above the cross-arm as much as the radius of the insulator, and, as the strain comes on the extreme top of the pin, it is obviously difficult to successfully support the largest size of insulators by means of the common pin and cross-arm construction. By using carefully selected woods, this has been successfully accomplished for insulators up to 11 ins. in diameter, but at 40,000 volts in bad weather such insulators carry enough current over their surface to char a wooden pin. Accordingly practice has settled to the use of iron pins in plants operating above 25,000 volts. At this voltage and below, the wooden pin can be

followed, no apprehension need be felt as to the safety of the line.

The most difficult problem at present encountered in the construction of high-tension transmission lines is that presented by the lightning arresters. For voltages up to 25,000, the non-arcing types of lightning arresters, either with or without series resistances, may be successfully used. Above this voltage and where large amounts of energy are available, these arresters are found to be short-lived, and up to the present time no thoroughly satisfactory arrester has been presented, which does not, when interrupting the ground circuit after a discharge, injure the insulation of the line and transformers. The horn form of lightning arrester developed in Germany has been found to operate with invariable success so far as the lightning arrester itself is concerned, but, as it is interrupting the ground circuit, it draws a large arc, and oscillations are produced on the line, which in many cases have been found to have more serious results than the discharge they were installed to remove. Condensers in parallel with the lightning arresters and ingenious arrangements of condensers and resistances have been used with some success, but none of these plans may be considered to be entirely satisfactory for the highest potentials operated from the largest generating plants.

In the operation of such lines every effort is made toward maintaining continuity of service. Such lines are carefully patrolled, even when it becomes necessary to build a special runway for the patrolman, and it is remarkable with what certainty these experienced men can predict the hours of life of a failing insulator, and provide for voluntary interruption of the service in time to remove the imperfection. Duplicate lines for long-distance work is an invariable necessity, though by far the best protection that can be offered for service is the supply of current from different power stations over lines following different routes. The present tendency is toward the consolidation of plants, not only for the purpose of decreasing the general operating expense, but more particularly for providing continuity in the case of the most serious accidents. No difficulty is experienced in operating in parallel plants widely separated, and where a number of plants are feeding into the same network, to certain plants are assigned the regulation of the entire system, others feeding the circuit being allowed to operate their machinery at full load continuously. The line capacity offers the most serious problem in determining regulation where the loads vary widely, but this quality becomes important

only for great variations of load, which, as the plants increase in size and load, are disappearing. Where proper care has been given to the installations of the lines and where duplicate lines and plants are provided for, care in operation and patrol of the lines has resulted in success both from the engineering and financial standpoint.

## SPARK DISTANCES CORRESPONDING TO DIFFERENT VOLTAGES.

BY H. W. FISHER.

Realizing the advisability of using sparking distances for determining impulsive rises of voltage, the writer commenced a series of experiments about the beginning of the last decade with a view to learning how the sparking distances varied with the voltage and the kind of points. The results obtained then showed that the subject was very complex and that the problem could only be successfully solved by using a great variety of points whose diameters had been carefully measured. Such work the writer undertook and accomplished sufficiently well for his own use. It was his intention, however, to go more fully into the subject and present his researches in the form of a paper. About that time Mr. Steinmetz read his excellent paper entitled "Dielectric Strength of Air" before the American Institute of Electrical Engineers.

After the adoption of the table giving the sparking distances corresponding to different voltages by the American Institute of Electrical Engineers, there has been a tendency to use this table for measurements of high voltage, and in the present paper it is the object of the writer to show the magnitude of the errors that may arise from the use of ordinary needle points.

For these investigations, current from 2,000-volt, 60-cycle generators was furnished by the Allegheny County Light Company. Through the kindness of Mr. W. A. P. Schorman of said company, the voltage and frequency were kept very constant, and while making individual tests the voltage seldom varied more than 1/10 per cent. Considering that our line was taken off of one of the regular lighting circuits this result can be considered remarkable, and such constancy was, of course, invaluable in our investigations.

The apparatus consisted of a water resistance placed in series with an auto-regulating transformer, and the lighting circuit. From the secondary of the auto-transformer, current was supplied to a large high-voltage transformer. By means of the regulator,



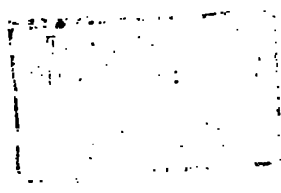



FIG. 1. STARB-GAP APPARATUS.

the high voltage could be varied by steps of 1 per cent, and the water resistance could be changed so as to give absolutely any voltage desired. The high voltage was measured by means of a Weston voltmeter placed in series with non-inductive resistances. The Weston voltmeter was very carefully calibrated by a potentiometer method, and its impedance, as well as those of the resistances used in series with it, were measured and the multiplying factors of the different resistances were calculated.

After all this preliminary work was done voltages could be measured to an accuracy of nearly 1/10 per cent.

Fig. 1 shows the spark-measuring apparatus, which consisted of a heavy base of hard rubber on which was mounted rigidly one needle-holder screw and micrometer, reading to .001". The other needle-holder could be moved forward or backward in a groove and fastened in any desired position to suit the length of needles employed. The actual needle-holders were provided with ball-and-socket joints so that the points of the needles could be placed exactly opposite each other. Concave discs of different diameters could be placed slightly back of the needle points as shown in the cut, where for the purpose of illustration and comparison a 4" and a 10" disc are placed over the holders. The writer found that by the use of said discs, the sparking distances were more uniform. The discs reduce the amount of brush discharges, which without them sometimes suddenly become sufficiently great to start a spark before the right distance is reached. The hard rubber handle is placed to the left of the apparatus. They do not prevent abnormal spark distances due to impulsive rises of voltage. Other advantages of their use will be mentioned later on. The apparatus was designed by the writer and made by The Leeds & Northrup Company of Philadelphia, Pa.

As the e.m.f. wave form of an alternating-current generator changes with the amount and kind of load, it was decided to make a few spark distance measurements at a definite voltage every time any tests were made, and to confine the experiments mostly to times of the day when the generator load would be fairly constant. The definite voltage referred to above was 25,240, which corresponded to a voltmeter reading of 83.5, the voltmeter multiplier being 302.4.

In order to always get a deflection of exactly 83.5 it was necessary to use a water resistance, and hence as a water resistance in the primary of a transformer has a tendency to change the relation

From all of these data, it was found that the spark distances for 25,000 volts mean effective pressure of sine curve should be 1.300". It then became a simple matter to correct all the measurements obtained to the basis of a curve of sines and the curves of Figs. 1 and 2 represent said connected results.

The curve of Fig. 3 gives the result of tests made with No. 12 Thomas Harper's needles. The main curve going up to 50,000 volts was made with the use of 10" discs. The subsidiary curve was obtained from tests made without the use of discs. Below 23,000 volts there is apparently no difference between tests made with and without discs. The discs seem to have a tendency to make the curve more nearly a straight line. The utmost care was taken with this work, and unless the form of the apparatus and surrounding conditions have an effect upon sparking distances, the writer believes the results herewith given are very accurate. The relative results at all events should agree very closely, and if at any time it should be found that the correct sparking distance for 25,000 volts be greater or less than 1.3", the values given by this curve can be modified to a proportionately greater or less degree.

The curve of Fig. 4 is made on a larger scale and with assorted needle points, none of which were blunt. By doing this, there were not many tests to be eliminated. The curve is practically a straight line through the upper range of voltages. Mention will be made later of the dotted line which becomes tangent to the curve and passes through the origin.

Table II gives a comparison between spark distances tests made with and without 10" discs. It will be noticed that the spark distances were more uniform with the use of discs than without them. A great many similar tests were made, all of which confirmed this point.

In most of the following tables, the measured diameter of the needle points is given. The points were measured by means of a microscope and glass grating containing 10,000 lines to the inch. The kind of points were classified into flat, round, and sharp, which are designated respectively by the letters *F*, *R*, and *S*. Each point was measured in two directions 90 deg. apart. Under the column headed "Kind of Points," will be found the measured diameters of both needle points used in the test. It will be noticed that many of the points were both round and flat, depending upon the direction in which they were observed. The "Distance between Discs" is the actual distance between them when the needle points

THE NATIONAL ARCHIVES  
PUBLIC INFORMATION CENTER  
ALSO AVAILABLE AT  
THE NATIONAL ARCHIVES



FIG. 2. LIQUID RHEOSTAT.

were touching, and each disc was placed half this distance back of the points.

Table III gives some very interesting tests made with 1000 volts, a great variety of diameters of points being employed. With this voltage it is at once evident that the sharper the point the longer becomes the sparking distance. It will be noticed that the sharpest needle point gave a spark distance equal .041", while with electrolytically prepared points spark distances of .048" and .052" were observed. On one occasion the writer made points which appeared still sharp under a magnifying power of 600 diameters, and with these points the spark distance was .054".

Referring now to Fig. 4 it will be observed that a straight line drawn tangent to the spark distance curve and passing through the origin intersects the 1000-volt line at .054". It is the writer's opinion that this straight line would represent the spark distance curve if infinitely sharp points were employed; other tests and curves which the writer obtained many years ago all tend to confirm this opinion. With polished pin heads the sparking distance was as low as .0025". The points of large diameters were made by rubbing the ends of the needles across a fine carborundum stone. It will moreover be noted that the sparking distance is controlled by the sharp point and not by the blunt one.

Table IV gives a great variety of experiments made with about 6200 volts. Section A of this table gives tests made with points of various diameters. A glance here will show at once that a maximum spark distance is no longer produced by sharp points, but by points which have a diameter approximating .0014"; this rather startling fact the writer discovered over 10 years ago, but did not then have the means of determining the diameter of the point which gives the maximum spark distance. The same results are in general true without the use of discs, but, of course, it may be possible that the diameter of points giving a maximum spark distance is different when discs are not employed.

The writer next tried to determine whether the blunt or sharp point was the controlling factor in determining the sparking distance. In doing this the astonishing fact was discovered that the sparking distances were always greatest when the large point was placed in the holder at the handle side of the apparatus when 10" discs were employed. When no discs were employed the exact reverse of the above occurred, the spark distance being the greatest when the small points were at the handle side of the apparatus.

Section C of Table IV shows that when 4" discs were employed the position of the small or large point had no effect upon the result, the sparking distance varying with the diameter of the point and being practically the same as what was obtained before, when blunt points of the same diameters were used. The 10" discs were not symmetrical, having been considerably warped in transportation, whereas the 4" discs were very symmetrical. Whether this was the cause of the peculiar phenomenon or whether it was due to the diameter of the discs, the writer did not have time to discover. It will be noted in section B that when 10" discs were employed the sparking distance depended entirely upon the kind of point which was placed at the handle side of the apparatus, whereas, when no discs were employed, the kind of point at the other side of the apparatus was the controlling factor.

Section D of this table gives tests made with different sides of the apparatus grounded, and the results were so uniform that for all practical purposes the grounding of either side of the circuit does not affect the sparking distance.

Section E shows tests which were made with a view to determining whether different diameters of discs had any effect upon the sparking distance. Considering that all these tests were made with current obtained from an ordinary lighting circuit, these results can be considered close enough to indicate that the size of the discs does not have any practical effect when 6000 volts are employed. This table shows us that by the use of points having a diameter of about .0014", the spark distance can be increased over 20 per cent more than what will be obtained by the use of sharp points. The measurement of several packages of needles shows that nearly every package had needles which measured as much or more than the above. Hence, while several tests would probably give quite close results, yet one or two tests cannot thoroughly be relied upon to give the correct sparking distance.

Table V gives the result of a number of tests made with 10,100 volts. Section A gives the tests which were made to determine the diameter of the point which would give the longest spark distance, and from careful examination it will appear that the maximum distance is obtained from points measuring about .0018". The distance does not seem always to depend upon the diameter of the points, because the seventh line of figures shows a comparatively small distance compared with the twelfth line,



where the points measured about the same. In the latter case, however, the points were round, and this may have been the cause of the difference. Here the maximum sparking distance is about 20 per cent greater than the minimum, and by making only one or two tests at this voltage without the use of measured points, an error of 10 or 20 per cent might have occurred.

Section B shows that when a large point is used on the handle side and a small point on the other side, that the spark distance is slightly greater than when the reverse is true. The difference, however, is not nearly so great as was the case when 6,000 volts were employed.

Section C verifies the tests made at 6,000 volts, namely, that when 4" discs were employed, the position of the large or small points in the holders does not have any effect on the results. The sparking distances for sections B and C do not seem to be quite so great for large points as was the case in section A, where both large points were used.

In section D no discs were used, and when the small point was on the handle side of the apparatus, maximum results were obtained which corresponded quite closely to those in section A. When the large points were on the handle side of the apparatus, the sparking distance is considerably less, and this corresponds with the results obtained with 6000 volts with this exception, that the difference is not quite so great.

Section E shows tests made with different sides of the circuit grounded, and the connection to earth does not appear to change the sparking distance. A close examination of section A will show that the sparking distances are proportionately longer for rounded points than for flat points of the same diameter.

Table VI gives a number of spark distance determinations made with 20,000 volts. Section A of the table gives a series of tests to determine the effect of points of different diameters. It will at once become apparent that at this voltage the spark distance varies but little with the diameter of the points. The maximum spark distance was obtained with points measuring .003", and was only about 3 per cent greater than the spark distance with sharp points.

Section B shows that when blunt and sharp points are used, the position of the point in the apparatus makes but little difference in the sparking distance. It will also be seen that at this voltage

the grounding of either side of the circuit does not affect the sparking distance.

Section C shows that when no discs are employed, the sparking distance is slightly increased by grounding the handle side of the apparatus.

The first test of section D shows that the sparking distance was about 0.005" greater with discs than without them. The rest of section D demonstrates that when 4" discs are used, and when different sides of the apparatus are grounded, the spark distances are probably slightly greater than those made with the apparatus not connected to earth. The results are apparently not so regular as those obtained by the use of 10" discs. Experiments demonstrated the fact that with high voltages better results were obtained by the use of large discs.

Table VII gives a number of tests made with 30,200 volts. In sections A and B will be found a comparison between spark distance tests made with and without the use of discs. The results were much more uniform when discs were employed, and the average spark distance is about .020" greater in section D where no discs were used than in section A where 10" discs were employed.

Section C gives the result of tests made to determine the effect of points of different diameters upon the sparking distance. A careful examination will show that there is nothing at all regular in this part of the table. The blunt points seem to be instrumental in starting discharges which were followed by an actual spark. In many cases there appeared to be a kind of resonant action. When the heterogeneous results given in section C are compared with the tests of A and B, the importance of using sharp points becomes very apparent. Of course, in many cases when number 12 needles were employed, the spark distances were abnormal, due either to an impulsive rise of voltage, or to the needle points being blunt. Such irregular results are not given.

Table VIII gives the result of experiments made with 40,000 volts. In section A an attempt was made to determine the effect of placing the discs at different distances apart, and as mentioned heretofore, the distances given are those at which the discs were separated when the needle points were touching. The sparking distance seems to be slightly increased as the distance between the discs is increased, but the probable difference is small.

Section B shows that the sparking distance was about .1" greater when no discs were used than was the case with 10" discs separated by a distance of  $1\frac{1}{2}$ ".

Section C shows that when blunt points are employed the sparking distances may vary through very wide limits. In both sections C and D the results are so irregular that no attempt at classification could be made. A number of other tests were made along this same line with similar results.

Section E illustrates the effect of grounding either side of the circuit. The results here are so irregular that it is impossible to tell whether a ground increases or decreases the sparking distances. This irregularity may be partly brought about by static discharges in the transformer. A great deal of time was spent in making tests at the higher voltages, and the results obtained were often very confusing, but the absolute necessity of using very sharp points was thoroughly demonstrated. About 2,000 needles were used in these experiments.

The e.m.f. wave curve of the generator furnishing current for these tests was probably very close to that of a curve of sines. On some occasions the sparking distance for 25,000 volts was 1.300", but generally it was slightly in excess of this.

Table IX gives a comparison between the sparking distances of the A. I. E. E. table, and those of the writer. Both show an exact agreement at 25,000 volts; above this point the institute distances are greater and below they are less. It is an interesting fact that the tables agree at 25,000 volts, which was the reference voltage used by the writer. The institute sparking distance table was based on Mr. Steinmetz's researches, and if he used large needle points in his investigations, his sparking distances above 25,000 volts should be greater than those of the writer; this may be the cause of the difference there, but it does not account for the shorter distances below 30,000 volts. At 45,000 volts the difference between the institute sparking distance and that of the writer is about 14 per cent, which means a difference of over 5,000 volts. In the case of voltage tests where the sparking distance is relied upon as an indicator of the voltage, this difference might become a very serious matter.

In order to prevent short-circuits when spark distance tests are being made, the writer designed the water resistance shown in Fig. 2, which is placed in series with the spark distance apparatus.

This apparatus was not used in these particular investigations. The tube is of glass, 4" diameter of hole and 20" long. It is filled with distilled water and has a resistance of about 25,000 ohms when the plunger is at the top. The plunger rod can be clamped in any desired position by a nut operating over a split-taper thread. Experiments made with 25,000 volts through 16,000 ohms resistance showed no appreciable difference in the spark distance with and without the resistance in circuit.

The writer believes that under the right conditions accurate results can be obtained with a properly designed apparatus. A number of the points shown on the curve of Fig. 1 were made months after others, and the close agreement is an indication of the accuracy obtainable.

If this paper will stimulate investigations in connection with this very fascinating subject, the writer believes that the spark distance method may become as reliable as it is easy to apply. Before this condition is reached, however, many tests will have to be made with widely different generating and transforming apparatus, both open-circuited and connected to cables, etc.

These experiments show that the best results are obtained by the use of very sharp points; that large concave discs make the spark distances more uniform; that with infinitely sharp points the spark distance curve up to at least 10,000 volts would probably be a straight line passing through the origin and having an equation.

Spark distance in inches = .000,054  $\times$  volts.

In conclusion, the writer wishes to acknowledge his thanks to Mr. Shakarian for much valuable assistance rendered in these researches. Also to the Westinghouse Electric & Mfg. Company, and finally to the Standard Underground Cable Company for the use of instruments and construction of special apparatus employed in the tests.

TABLE I.

Water resistance setting.	Water resistance in ohms.	Increase of sparking distance multiplying factor.
5	17	1.000
10	25	1.000
15	33	1.000
20	41	1.001
25	49	1.001
30	57	1.002
35	65	1.004
40	73	1.007
45	81	1.011
50	89	1.017
55	97	1.025
60	105	1.040

TABLE II.—DISTANCE BETWEEN DISCS, 1 INCH.

Sparking distance in inches.	Mean effective voltage.	Diameter of points in .0001 inches.	Discs used.
1.809	25,200	No. 12 T.H.P.B.	"A"
1.811	"	"	10 inch.
1.811	"	"	10 "
1.809	"	"	10 "
1.841	"	"	10 "
1.835	"	"	Nona.
1.818	"	"	"
1.821	"	"	"

TABLE III.—DISTANCE BETWEEN DISCS, 1/2 INCH.

Sparking distance in inches.	Mean effective voltage.	Diameter points in .0001 inches.	Discs used.
.025	1001	5 F. 4 R. 4 F. 5 R.	10 inch.
.0125	"	15.16 F. 15.16 F.	"
.025	"	4.3 R. 4.3 R.	"
.012	"	7.9 R. 8.8 R.	"
.041	"	2.2 S. 2.2 S.	"
.040	"	2 F. 2 S. 2.2 S.	"
.0115	"	20 F. 15 R. 20 F. 15 R.	"
.025	"	3.3 R. 3.3 R.	"
.014	"	5.5 R. 6.6 R.	"
.0225	"	5.5 F. 6.6 F.	"
.012	"	50.50 F. 50.50 F.	"
.025	"	Pin heads.	"
.024	"	Pin head. 2.2 S.	"
.0275	"	20.20 F. 20.20 F.	"
.0225	1023	Pin heads.	"
.0515	1000	Very sharp points.	"
.043	"	" " "	"

FISHER: SPARK DISTANCES.

TABLE VI.—DISTANCE BETWEEN DISCS, 1 INCH.

Sparking distance in inches.	Mean effective voltage.	Diameter of points in .0001 inches.	Discs used.
1.047	90,200	3.3 R. 3.4 R.	A.
1.044	"	6 F. 7 R. 7 F. 6 R.	10 inch.
1.048	"	16 F. 18 R. 16.16 R.	"
1.075	"	30.29 F. 30.29 F.	"
1.067	"	24.26 F. 24.26 F.	"
1.055	"	22.23 R. 23.23 R.	"
1.052	"	22.23 F. 22.23 F.	"
1.061	"	20.22 F. 20.20 R.	"
1.059	"	25.25 F. 23.23 F.	"
1.051	"	22.20 F. 22.20 F.	"
1.053	"	4.6 F. 26.25 F.	B.
1.079	"	4 F. 5 R. 26.25 F.	10 inch.
1.045	"	4.4 R. 5.5 R.	"
1.048	"	6 F. 4 R. 6 F. 7 R.	"
1.047	"	No. 12 T.H.B.P.	C.
1.052	"	"	10 inch.
1.071	"	"	None.
1.061	"	"	"
1.054	"	"	"
1.060	"	"	"
1.053	"	No. 12 T.H.P.B.	D.
1.048	"	"	None.
1.060	"	"	4 inch.
1.055	"	"	"
1.056	"	"	"
1.047	"	"	"
1.060	"	"	"
1.048	"	"	"

1. Large point near handle.
2. Small point near handle.
3. Handle side grounded.
4. Other side grounded.
5. No grounding.

TABLE VII.—DISTANCE BETWEEN DISCS, 1 INCH.

Sparking distance in inches.	Mean effective voltage.	Diameter of points in .0001 inches.	Discs used.
1.585	80,200	No. 12 T.H.P.B.	A.
1.580	"	"	10 inch.
1.593	"	"	10 "
1.580	"	"	10 "
1.591	"	"	B.
1.603	"	"	None.
1.607	"	"	"
1.599	"	"	"
1.601	"	"	"
1.608	"	3 R. 2 S. 2 2 S.	"
1.918	"	27.27 F. 27.26 F.	C.
2.000	"	25.24 F. 25.26 F.	10 inch.
2.092	"	23.28 F. 26.25 F.	10 "
2.145	"	20.20 F. 21.20 F.	10 "
2.183	"	19.20 F. 20.23 F.	10 "
2.220	"	17.17 F. 18.16 F.	10 "
2.170	"	22.25 F. 23.23 R.	10 "
2.236	"	16.20 F. 15.15 R.	10 "
2.401	"	22.24 F. 22.21 F.	4 "
2.322	"	18 F. 18 R. 13 F. 18 R.	None.
2.280	"	17.17 F. 19.17 F.	"
2.280	"	26.27 F. 26.27 F.	"

TABLE VIII.—MEAN EFFECTIVE VOLTAGE, 40,000.

Sparking distance in inches.	Diameter of points in .0001 inches.	Discs used.	Distance between discs.
2.121	4.6 F. 4.5 F.	A. 10 inch.	1½ inches.
2.125	No. 12 T.H.P.B.	10 "	2 "
2.150	" "	10 "	2 "
2.145	5 F. 2 S. 2 F. 2 S.	10 "	2 "
2.120	3.3 R. 3.3 R.	10 "	1½ "
2.181	3.3 R. 4.3 R.	10 "	3 "
2.211	No. 12 T.H.P.B.	B. None.	
2.241	" "	" "	
2.226	" "	" "	
2.195	17.18 F. 17.18 F.	C. None.	
2.160	23.25 F. 25.27 F.	" "	
2.169	17.18 F. 17.18 F.	10 inch.	2 "
2.263	17.17 F. 17.17 F.	None.	
2.022	22.25 F. 5.3 R.	D. 10 inch.	2 "
2.272	19.19 F. 3.4 F.	10 "	2 "
2.026	7 F. 6 R. 7 F. 6 R.	E. 10 inch.	2 "
2.022	6 F. 7 R. 6 F. 7 R.	10 "	2 "
2.117	5.7 R. 5.6 R.	1 "	2 "
2.150	4.5 R. 5.6 R.	10 "	2 "

1. Large point near handle.
2. Small point near handle.
3. Handle side grounded.
4. Other side grounded.

TABLE IX.

Volts.	SPARKING DISTANCES, IN INCHES.		
	A. I. E. E.	FISHER'S.	
		Discs.	No discs.
10,000	.470	.540	.....
20,000	1.000	1.040	.....
25,000	1.300	1.300	1.314
30,000	1.625	1.580	1.600
40,000	2.450	2.140	2.220
45,000	2.950	2.440	2.580
50,000	3.550	2.770	.....

DISCUSSION.

Dr. LOUIS BELL: The topic of Mr. Fisher's paper is one that is most pertinent in high-voltage work, inasmuch as at the pressures now used the ordinary instrumental methods are subject to considerable errors, and are rather difficult to apply; so that there are many cases of high-pressure transmission work where the power of quantitatively using this sparking-distance method would be very valuable. The interesting feature of the paper seems to me to be the tendency of these points to accumulate in

a straight line. The straight line relation is just what we want if it will kindly hold through over a wide range of voltages.

Mr. C. E. SKINNER: A few years ago the American Institute of Electrical Engineers adopted as a standard for high-voltage measurements the striking distances between needle points, for e.m.f.s up to 150,000 volts, also specifying a definite method of procedure in making insulation tests, using this method for determining the voltage of test. In the use of this method it was found that the sparking distances varied for conditions which, as far as could be determined, were exactly the same, these variations being as much as 10% or even more. Consequently, the tests were not reliable, and when very high voltages were used, this amount of variation might lead to considerable trouble. It is only through such careful methods as those described by Mr. Fisher and by the use of some of the devices he has described, that any reliability is assured in the use of a spark-gap for measuring the voltage of a testing circuit. The speaker has known something of Mr. Fisher's work during its progress, and wishes to express his appreciation of the painstaking care which Mr. Fisher has exercised in the carrying out of this work. It is no easy thing to secure needles that are still sharp under a magnification of 600 diameters, to line them up, and to measure the distances between their points, but Mr. Fisher's results show that he has successfully accomplished this work. Another difficulty encountered in the use of spark-gaps for insulation testing purposes, was the rush of current and consequent rise of potential on the outer turns of the testing transformer and in some cases on the turns of the apparatus tested. The use of a resistance in series with the spark-gap obviates this difficulty, and it is very gratifying to know from Mr. Fisher's work that the use of such a resistance is allowable.

Dr. BELL: I would like to ask Mr. Fisher two things with respect to the curves given. First, using the regular commercial needle of such type as he gave there, what is the error introduced into the curve? What percentage of error is introduced by the use of a supply of commercially sharp needles rather than by those which are carefully sharpened for the purpose in making tests? And, second, whether he detected any error due to condenser action on the discs as a possible disturbing cause in the sparking distances? At the high voltages I particularly noted that the difference between sharp and blunt points seemed to disappear or reverse or change in various ways, and it at once occurred that with these large discs at thirty, forty, fifty, sixty thousand volts, the condenser action might cut a very considerable figure in modifying the conditions of strain or even the effective voltage at the discharge points.

Mr. FISHER: Answering Doctor Bell's first question I will say that the error introduced by this kind of points varies with different voltages. If you are making tests at about 1000 volts, the error may be very great indeed, because it is possible to have needle points, taken from an ordinary pack of needles, which will give spark distances varying from .012 inch to .040 inch. With 10,000 volts, the points can vary from .000,2 inch to .000,8 inch without effecting the sparking distance to any appreciable degree; above .000,8 inch the sparking distance increases until a maximum



is reached near .002 inch. Now there seems to be a kind of law which is true in most instances and which may be stated as follows: Given two kind of points, a spark distance will correspond to that point which when tested with a similar point gives the maximum spark distance. To illustrate, at 1000 volts, a maximum spark length is produced with sharp points. If a test is made with one sharp point and one blunt point, the spark length will correspond to that obtained with sharp point. While with 10,000 volts a maximum sparking distance is obtained with points about .002 inch in diameter, and if a sharp point is used with another point measuring about .002 inch in diameter, the spark length will correspond to that of the blunt point which in this case gives a maximum distance. On account of this fact and because a pack of needles may contain both sharp and dull points, one spark length test can not be relied upon where accuracy is desired. But as I said before if you will examine the brush discharge at the points and get familiar with its appearance under normal conditions, you can at once tell, at the time of the discharge, whether the condition is regular or abnormal. If it is a regular condition, as you advance the needle points you will get a gradually increasing brush which, near the normal sparking distance, becomes much more pronounced, and under normal conditions, by observing said brush discharge, it is possible to tell when the spark will occur within a few thousandths of an inch, with pressures above 6,000 volts. Now, if you happen to have a dull point, which will give a longer sparking distance than is obtained with sharp points, you will not get the normal brush discharge, a spark occurring before the points are close enough to produce the normal effect. In like manner by observing the brush discharges, you can tell if the spark is produced by an impulsive rise of voltage due to resonance, etc. As stated in the paper it is possible to get large errors when the points are not measured. But if you make several tests and you eliminate the erratic ones good results can be obtained.

Dr. BELL: Take a paper of No. 12 sharp needles and use them, we will say, for experiment, at 10,000 volts and upwards; how large an average deviation would you get from your curve as you substitute one of these needles from the same paper for another? In general, how large an error are you likely to introduce, if you work with your standard commercial needles without calibrating their points?

Mr. FISHER: I will speak of 25,000 volts first because this was the reference voltage and there were tests made every time at this voltage. At 25,000 volts we found that the distances should agree within 3 or 4 thousandths of an inch when the operating conditions were normal, and that is practically true also at 10,000 volts. But as I said in making these tests, you may get abnormal spark distances due to the points not being sharp or to causes connected with the operation of the generator.

Dr. BELL: You are answering the theoretical part of the question most efficiently; but what I am trying to get at is this: If I take a paper of needles, lining them up carefully and going to work, we will say, at twenty or twenty-five thousand volts, and so on, up to forty or fifty or sixty thousand volts, how great casual errors am I likely to introduce — how

33924A

much departure from your curve — by the different sharpness of the needles as they commercially exist, as you take them out of the paper?

Mr. FISHER: I might say offhand that in two or three tests you are not apt to get much more variation than 2 or 3% and often the agreement is very much closer than this.

Dr. BELL: That is very satisfactory. Could you trace any effect of the condenser action of these guard plates, when it came to those higher voltages?

Mr. FISHER: Only in this way, that the sparking distance is less when the guard plates are used for voltages above 23,000 volts; but if the plates are set within one-fourth of an inch of the same distance back of the needle points every time, the results are consistent, and agree better with plates, than without them.

Chairman SCOTT: In electrical work we have been restricted to the use of a few definite materials. The three general classes are iron, copper and insulation. There is nothing which can take the place of iron; there has, until recently, been nothing which takes the place of copper, but aluminum has been a formidable rival of copper in transmission work during the last few years. Copper has had many years of evolution. The ways of drawing the wire, its physical characteristics, adapting it both electrically and mechanically to its purposes, have been worked out by years of experience. Aluminum has come into the field within a few years, and it is quite an important matter to have its physical characteristics and mechanical constants. These are being developed by experience and each year brings to us new data.

## THE USE OF ALUMINUM AS AN ELECTRICAL CONDUCTOR.

BY H. W. BUCK.

About the year 1898, the price of aluminum had been so reduced by the commercial application of the Hall process, that this metal began to come into prominence as a competitor of copper for use as an electrical conductor. In physical characteristics, aluminum differs materially from copper. Its properties give it some advantages, and some disadvantages. Some of its physical constants as it is now manufactured commercially for electrical purposes are as follows: Melting point, 1157 deg. Fahr.; elastic limit, 14,000 lbs. per sq. in.; ultimate strength, 26,000 lbs. per sq. in.; modulus of elasticity, 9,000,000; electrical conductivity, 62 per cent; specific gravity, 2.68; co-efficient of linear expansion, .000,012,8.

On account of its properties, aluminum is not applicable to all the purposes for which copper is used electrically. At present its electrical utility is confined to (a) bus-bars, (b) high-tension overhead uninsulated conductors, (c) low-voltage feeders, usually insulated with weatherproof braid only.

Aluminum is barred from use in a number of cases on account of the practical impossibility of applying the ordinary methods of soldering. Its surface seems to have a coating of oxide on it at all times, which prevents the adhesion of the soldering metal.

At the present relative cost of the two metals, aluminum is about 10 per cent, or 15 per cent, cheaper than copper of the same resistance. The weight of a unit length of aluminum wire is only 47 per cent of a copper wire of the same length and resistance. Consequently aluminum can cost  $\frac{1.0}{0.47} = 2.13$  times as much as copper per pound and still cost the same as copper per unit length from the standpoint of electrical resistance. As a matter of fact, however, the price of aluminum at present is less than 2.13 times that of copper per pound, so that it is actually cheaper to use aluminum as an electrical conductor than copper, where other considerations do not enter.

*Use for Insulated Cable.*

For all forms of wire and cable which have to be insulated with expensive materials, such as rubber, aluminum is at a decided disadvantage. Its lower conductivity necessitates a greater diameter than a copper conductor of the same resistance, and the extra cost of insulation required to cover the aluminum prevents it from competing with copper for this particular purpose on the basis of the present relative costs of the two metals.

*Interior Wiring.*

The difficulty in soldering aluminum wire conveniently, and the greater cost of covering it with insulation, renders its use for interior wiring practically out of the question.

*Telephone Wires.*

The high co-efficient of expansion of aluminum wire, and its comparatively low tensile strength, causes a greater sag at high temperatures than with copper in overhead line work. In telephone construction, where the wires, by necessity, are strung close together on the crossarms, this greater sag of aluminum would probably result in contact between wires at the deflections which would occur at summer temperatures. For this reason, together with the soldering difficulty, where lateral connections are made, aluminum is practically shut out of competition with copper for this particular use. There is also some objection to the use of aluminum wire as small as that required for telephone purposes, on account of the necessity of stranding it. There is no reason, however, why aluminum should not be used as a conductor for isolated aerial telephone lines, if a large enough wire can be used. In cases known to the writer where it has been used for such telephone circuits, it seems to have operated as a particularly good carrier of the voice. This may possibly be due to the particular balance which exists in an aluminum wire between resistance, inductance and capacity, aluminum having somewhat less self-induction, and more capacity, than a copper wire of the same resistance.

*Bus-Bars.*

Aluminum is particularly well suited for bus-bar constructions. Here no insulation is usually required over the bus-bar metal, while the great saving in weight, and the lower cost, are decided advan-

tages in favor of aluminum. Care should be taken, however, in using aluminum for such purposes, to provide for expansion and contraction with changes in temperature, which is greater in aluminum than in copper. The increased section of an aluminum bar over a copper bar of the same resistance, affords greater radiating surface and allows a given current to be carried with a lower rise in temperature. Consequently, for a given temperature rise, which is usually the limitation in a bus-bar installation, and not "drop," an aluminum bar will weigh only about 38 per cent of a copper bar for the same heating. This is an obvious advantage for aluminum. Such bars are being used extensively for carrying currents of very large volume, such as are required in low-voltage electrolytic plants.

#### *Low-Voltage Feeders.*

A very wide application of aluminum has developed for low-voltage direct-current feeders, especially for railway work. Sizes up to 2,000,000 cm are in use for railway feeders, the cables being usually covered with weatherproof braid. Aluminum has many especial advantages for this purpose. The quality of the poles and crossarms frequently installed for the support of railway feeders is not of the best, and the 53 per cent reduction in weight in the use of aluminum saves in maintenance and in line breakdowns. The cost again enters as a 10 per cent or 15 per cent advantage. Furthermore, the increased radiating surface of the aluminum feeder allows a greater overload to be carried by it than with copper, without melting out the compound of the weatherproof braid, which happens so frequently in copper feeders from overheating, when cars become bunched on the line.

#### *High-Voltage Overhead Lines.*

The most prominent use of aluminum, electrically, and the one over which there has been the greatest amount of discussion, is that for overhead high-voltage transmission circuits. When aluminum was first introduced for overhead conductors, it was furnished in the solid form. Considerable trouble was experienced with this kind of wire from breakage resulting from flaws in the metal, and from "crystallizing" of the wire from swaying in the wind. About the year 1900, the stranded form was substituted for even the smallest sizes (No. 4 B. & S.), and the original trouble from breakage has been entirely eliminated.

by the projected area of the cable in square feet, gave directly the wind pressure per square foot on the cable. Fig. 1 shows the results of these observations to date. The highest wind velocity experienced so far has been 40 miles per hour indicated ( $33\frac{1}{2}$  miles per hour actual). The curve drawn represents about the average of all the observations and it is expressed by the formula

$$P = .0025 V^2$$

where  $P$  = pressure per square foot of projected cable area, and  $V$  = actual velocity of wind (not indicated velocity) in miles per

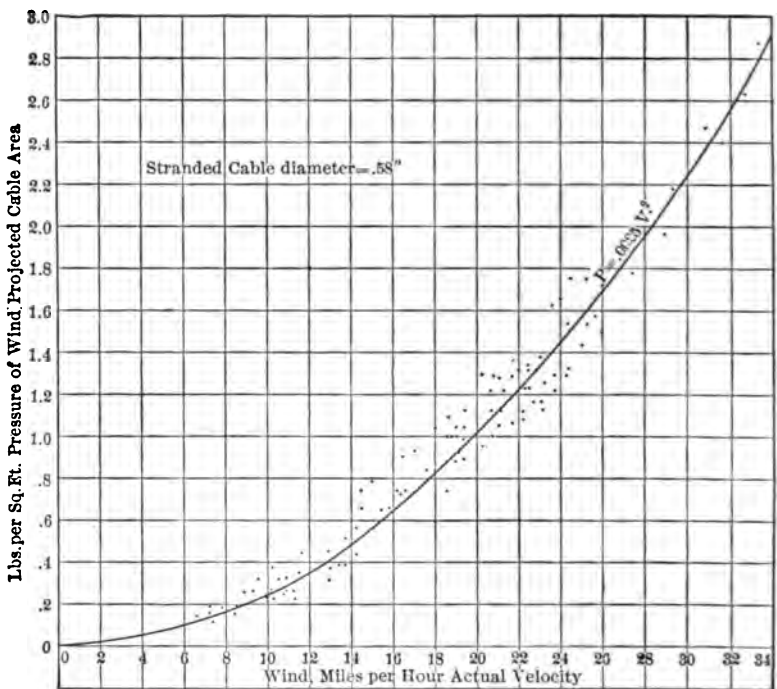

FIG. 1. WIND PRESSURE CURVE.

hour. The reason for variance in the observations is due to the fact that the wind-pull on the wire observed was proportional to the average wind velocity throughout the whole span, whereas the wind velocity observed by the anemometer, in connection with the pull, was merely that at the center of the span. The average of the observations, however, is believed to be close to the correct figure. The observations will be continued during the coming

winter, and it is hoped that the curve can be extended by some records at higher wind velocities.

The equation  $P = .002 V^2$  has been established by some other experimenters on wind pressures for cylindrical surfaces. The fact that the constant in the writer's observations has been higher than this is believed to be due to the fact that a stranded cable offers greater resistance to the wind than a pure cylinder of the same diameter.

In the curves and tables given in this paper showing the relation between span-length, deflection, temperature, etc., the equation  $P = 0.0025 V^2$  is taken as a basis for wind pressure.

Having determined the value of wind pressure for a given velocity, it is next of equal importance to determine the maximum velocity to which a transmission line is likely to be exposed. A study of the records of the United States Weather Bureau brings out the following points:

1). The wind velocities reported by the United States weather stations are *indicated* velocities, not *actual* velocities, the correction factors being shown in the following table:

Indicated velocity, miles per hour.	Actual velocity, miles per hour.
0	0
10	9.6
20	17.8
30	25.7
40	33.3
50	40.8
60	48.0
70	55.2
80	62.2
90	69.2
100	76.2

2). Maximum wind velocities do not occur at very low temperatures.

3). The highest regular winds occur on the actual sea-coast, the exception being tornadoes of very narrow path, which usually occur inland and which blow at unknown velocities, probably 200 miles per hour, or more.

4). With the exception of tornadoes, and gales which blow on the tops of high peaks, Point Reyes, Calif., and other places which

might be considered as freak localities, the highest winds recorded do not exceed 100 miles per hour indicated, or about 76 miles per hour actual velocity. Winds of even this velocity occur only on the sea-coast and are seldom, if ever, experienced inland. The following figures show the highest winds on record for the past ten years at some of the cities in this country (tornadoes excepted, which are not on record):

Place.	Wind velocity, indicated, miles per hour.	Wind velocity, actual, miles per hour.
Bismark, N. D. ....	72	56.6
Eastport, Me. ....	78	60.8
Buffalo, N. Y. ....	90	69.2
New York City . ....	78	60.8
Galveston, Tex. ....	84	65
Savannah, Ga. ....	76	59.4
Salt Lake City . ....	60	48

None of the above winds blew at very low temperatures.

5). The records of the Weather Bureau are all taken at high points, such as at the tops of high buildings, etc., which are 100 feet or more above the ground. The wind velocity decreases rapidly as the ground level is approached, and at the level of an ordinary transmission line, the velocity is about 30 per cent less than at a point 100 feet or more above the ground.

Assuming then that 100-miles-per-hour indicated velocity is the maximum likely to be experienced at the elevation of a weather station, this would be only 76-miles-per-hour actual velocity, and 30 per cent less for the level of a transmission line, or about 55 miles per hour actual. According to probabilities, even this would not occur at minimum temperatures.

In the curves which are given in this paper, 65 miles per hour actual velocity at minimum temperature is taken as a basis for maximum wind-pressure, and it is believed that this is high enough to meet any probable wind stress except that due to a tornado. The speed of 65 miles per hour at minimum temperature corresponds to about 80 miles at maximum temperature in the stress which it produces on a wire. In regard to tornadoes, their velocity is so high that it is commercially impossible to build all lines strong enough to withstand them. It must be remembered that even if the wind should exceed the velocity assumed in this paper



as a safe commercial maximum, the worst that could happen would be a stretching of the wire up to a new deflection corresponding to the higher wind-tension. The reduction in area of the wire

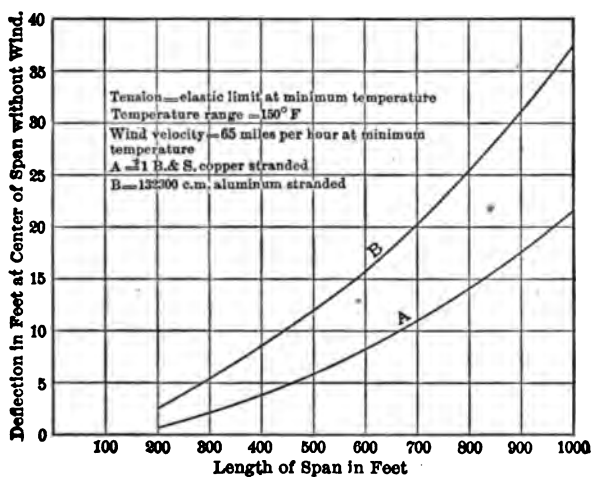

FIG. 2. DEFLECTION CURVE AT MAXIMUM TEMPERATURE.

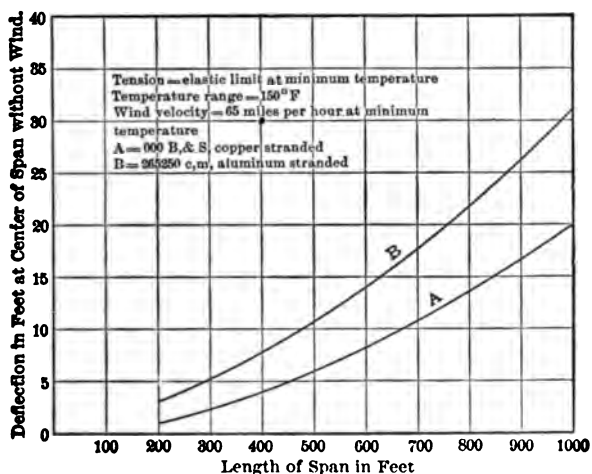

FIG. 3. DEFLECTION CURVE AT MAXIMUM TEMPERATURE.

would be only a small fraction of one per cent, and the slack could be taken up in a few hours' work after the wind had passed.

Figs. 2, 3 and 4 show the comparative deflections between aluminum and copper for various sizes of conductor, for span-lengths from 200 ft. to 1,000 ft. The deflection shown is that which would result at 150 deg. F. above the minimum temperature without wind, if the line was strung so that at minimum temperature, and 65-miles-per-hour actual wind velocity directly at right angles

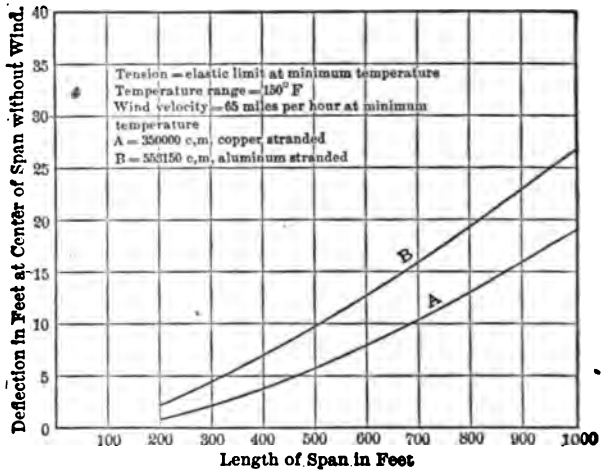

FIG. 4. DEFLECTION CURVE AT MAXIMUM TEMPERATURE.

to the line, the wires would be stressed to their elastic limit. The following data are assumed in all the calculations:

	Aluminum.	Copper.
Elastic limit per sq. inch.....	14,000 lbs.	40,000 lbs.
Coefficient of expansion per deg.	0.000,012,8	0.000,009,6
Modulus of elasticity.....	9,000,000	16,000,000
Temperature range.....	150° F.	150° F.
Wind velocity at min. temp., per hr.	65 miles	65 miles
Wind pressure per square foot.....	10.5 lbs.	10.5 lbs.

It will be noticed from the curves that the deflection is larger with small wires than with large ones. This results from the fact that the strength to resist wind pressure increases in proportion to the square of the diameter of the wire; whereas the wind pressure increases only directly as the diameter. Fig. 5 shows the deflections which would exist if there were no wind stresses.

Aluminum in this case closely approaches copper in deflection. This curve in comparison with curves 2, 3 and 4 illustrates the importance of taking wind pressure into consideration in all calculations for long-span constructions.

This question of deflection at maximum temperature without wind is of vital importance for it determines the height of the supports necessary to keep the conductor at a safe distance from the ground under extreme temperature conditions. This height of support establishes to a considerable extent the cost of the transmission line, and it is an especially important matter in long-span constructions.

An inspection of the curves shows that aluminum is at a disadvantage compared with copper in this matter of deflection where long spans are considered. For example, supports for 400-foot

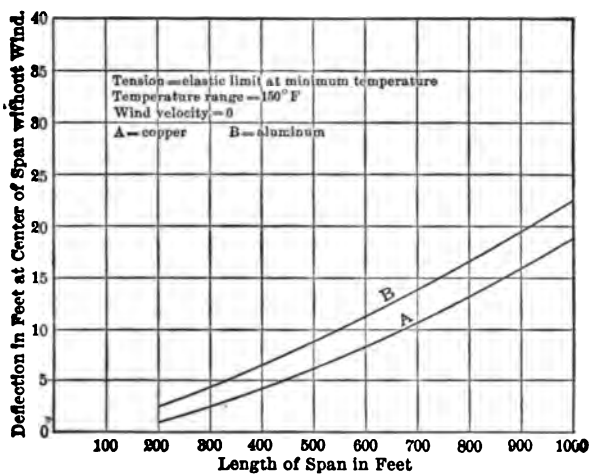

FIG. 5. DEFLECTION CURVE AT MAXIMUM TEMPERATURE.

spans of aluminum of 265,000 cm section will have to be 3.4 ft. higher than the supports for equivalent copper. For spans of 300 feet or less the matter of deflection is unimportant, for it makes little difference whether the deflection is two feet or three feet, more or less. But in very long spans where the difference may be 20 feet in the case of copper and 30 feet in aluminum, the question of deflection is of considerable moment, and the advantages are in favor

TABLE II.—DIMENSIONS AND RESISTANCES OF ALUMINUM STRANDED CABLES EQUIVALENT IN RESISTANCE TO STANDARD SIZES COPPER. RESISTANCE AT 75° F. RESISTANCE PER MIL-FOOT, 68 CONDUCTIVITY AT 75° F. = 16.949 OHMS.

SIZE COPPER.	Aluminum equivalent, Circular mils.	Diameter, Aluminum, Stranded inches.	Area, Aluminum, Square inches.	Ohms per 1000 feet, Aluminum.	Ohms per mile, Aluminum.	Pounds per 1000 feet, Aluminum.	Pounds per mile, Aluminum.	Feet per pound, Aluminum.	Elastic limit, Aluminum.	Ultimate strength, Aluminum.
1,000,000 CM..	1,580,700	1.45	1.2415	.01072	.05660	1454	7678	.6878	17380	32280
950,000 CM..	1,501,700	1.41	1.1794	.01129	.05961	1381	7291	.7242	16510	30660
900,000 CM..	1,422,600	1.38	1.1172	.01191	.06288	1309	6912	.7640	15640	29350
850,000 CM..	1,343,500	1.34	1.0552	.01261	.06658	1236	6526	.8085	14770	27430
800,000 CM..	1,264,400	1.29	.9924	.01340	.07075	1163	6141	.8600	13900	25820
750,000 CM..	1,185,300	1.25	.9310	.01430	.07550	1091	5761	.9166	13130	24210
700,000 CM..	1,106,300	1.21	.8690	.01533	.08094	1018	5375	.9824	12160	22560
650,000 CM..	1,027,300	1.17	.8076	.01650	.08712	945.0	4989	1.0582	11300	20980
600,000 CM..	948,400	1.12	.7448	.01787	.09495	872.5	4554	1.1460	10430	19370
550,000 CM..	869,400	1.07	.6828	.01884	.09947	799.8	4233	1.2551	9560	17750
500,000 CM..	790,400	1.02	.6208	.02144	.11320	727.2	3839	1.3733	8690	16140
450,000 CM..	711,150	.97	.5586	.02383	.12580	654.4	3457	1.5282	7820	14520
400,000 CM..	632,300	.92	.4966	.02680	.14150	581.7	3071	1.7192	6950	12910
350,000 CM..	553,150	.86	.4345	.03064	.16180	509.0	2687	1.9648	6080	11300
300,000 CM..	474,200	.79	.3724	.03574	.18870	436.2	2303	2.2927	5210	9680
250,000 CM..	395,150	.72	.3103	.04289	.22650	363.5	1919	2.7511	4340	8070
000 B&S.	334,450	.66	.2627	.05068	.26760	307.7	1625	3.2500	3680	6830
000 B&S.	285,250	.59	.2083	.06390	.33740	244.0	1288	4.0985	2920	5420
210 B&S.	210,300	.53	.1652	.08090	.42550	193.5	1022	5.1680	2310	4290
0 B&S.	166,850	.47	.1310	.10170	.53700	153.5	810.5	6.5150	1880	3410
1 B&S.	132,300	.42	.1039	.12810	.67640	121.7	642.6	8.2170	1450	2700
2 B&S.	101,900	.37	.0824	.16160	.85320	96.5	509.5	10.3633	1150	2143
3 B&S.	83,190	.33	.0653	.20370	1.0763	76.5	403.9	13.0730	914	1700
4 B&S.	65,980	.30	.0518	.25690	1.3563	60.7	320.5	16.477	726	1350
5 B&S.	52,320	.26	.0411	.32390	1.7103	48.2	254.5	20.750	575	1070
6 B&S.	41,490	.23	.0326	.40850	2.1570	38.2	201.7	26.180	456	850

Conductivity copper calculated for 98, Matthiessen standard scale.  
 Elastic limit aluminum = 14,000 lbs. per square inch.  
 Ultimate strength aluminum = 26,000 lbs. per square inch.

TABLE III.—DEFLECTIONS IN FEET WITHOUT WIND. ALUMINUM CABLE.

Rise above minimum temperature F°.	200 FOOT SPAN.			400 FOOT SPAN.			600 FOOT SPAN.			800 FOOT SPAN.			1,000 FOOT SPAN.		
	533,150 CM.	295,400 CM.	182,300 CM.	533,150 CM.	295,400 CM.	182,300 CM.	533,150 CM.	295,400 CM.	182,300 CM.	533,150 CM.	295,400 CM.	182,300 CM.	533,150 CM.	295,400 CM.	182,300 CM.
0°	.42	.45	.46	1.80	1.95	2.20	4.3	5.1	6.2	8.3	10.3	14.0	13.9	18.6	26.0
20°	.51	.52	.55	2.20	2.42	2.75	5.1	6.1	7.2	9.5	11.7	15.4	15.6	20.3	27.6
40°	.65	.65	.69	2.70	2.90	3.40	6.0	7.1	8.4	10.8	13.2	16.9	17.3	22.0	29.0
60°	.83	.85	.92	3.35	3.70	4.20	7.0	8.2	9.7	12.3	14.7	18.3	19.1	23.8	30.5
80°	1.07	1.13	1.30	4.15	4.50	5.10	8.2	9.5	11.0	13.8	16.4	19.6	20.8	25.5	31.8
100°	1.57	1.65	1.82	5.05	5.45	6.00	9.5	10.8	12.2	15.4	17.7	20.9	22.5	27.1	33.1
120°	2.20	2.27	2.45	6.00	6.40	7.00	10.8	12.0	13.3	16.9	19.1	22.2	24.2	28.6	34.4
140°	2.75	2.80	2.95	6.90	7.35	7.85	11.9	13.1	14.4	18.3	20.4	23.4	25.9	30.0	35.8
150°	2.97	3.03	3.10	7.20	7.78	8.50	12.5	13.6	15.7	19.0	21.5	25.5	26.7	31.5	37.5

Wire stressed to elastic limit at minimum temperature with 65 miles per hour actual wind velocity.

Next assume the temperature to rise 150 deg. F. The wire will then expand an amount shown in equation (5)—

$$L_m = 999.432 (1 + .000,012,8 \times 150) = 1.92 \text{ ft.}$$

Length unstressed then at maximum temperature will be  $999.432 + 1.92 = 1,001.352$  ft., which corresponds to a deflection [from equation (3)] of 22.5 ft.

Next assume, hypothetically, that the wire has its normal weight restored. It will then sag down from the above deflection until such a new deflection is reached that the tendency to elongate due to gravity stress is just balanced by the elastic tendency to contract. This will be the deflection sought for in this problem. It can be found graphically as follows:

Starting with the deflection at maximum temperature and zero tension (22.5 ft.) assume certain increasing tensions in the wire and find the corresponding deflections by applying equation (4), to get the increased length and equation (3) which will give the corresponding deflection. Plot these tensions and deflections (Fig.

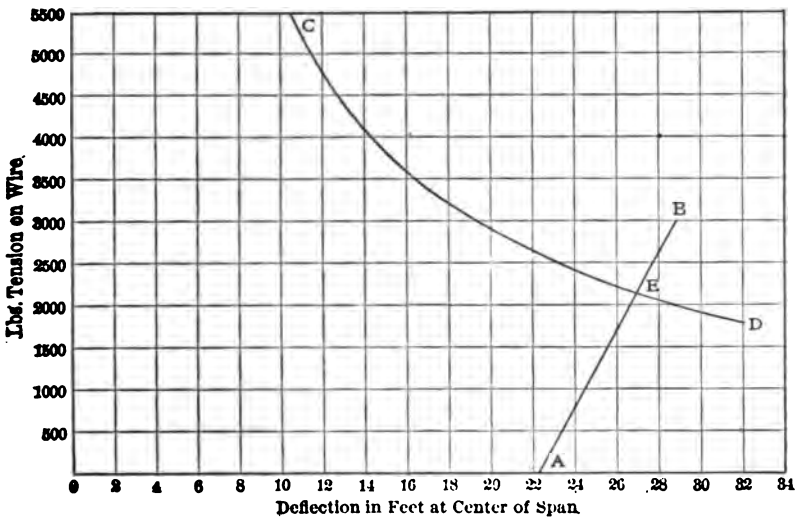

FIG. 6.

6) which gives the curve AB. This curve represents the relation between tension and resulting deflection in the wire as the wire sags down under gravity stress from its hypothetical position of zero tension. Next plot a curve CD (Fig. 6) by substituting vari-

ous values for  $T$  in equation (1) where  $W$  = the weight of the wire per foot.

This curve shows the relation between tension and deflection in the wires at various tensions when it is assumed to have its normal weight per foot.

The point of intersection  $E$  of these two curves is the point of equilibrium and the deflection corresponding to this point (27 ft.) is the deflection in question. It is the point where the force of elastic contraction is balanced by the gravity stress.

This problem can be solved analytically by a number of methods but the process leads to complex cubic equations, and a graphical method brings out more clearly the physical relations in the proposition. For this reason it is given here in detail.

## CONDUCTORS FOR LONG SPANS.

---

BY FRANCIS O. BLACKWELL

---

As electric power is transmitted over greater distances and transmission plants grow in size, more attention must be given to the importance of improving the construction of transmission lines.

A very large number of transmissions of from 50 to 150 miles are now in operation, many of them with several main circuits radiating from a common power center, with other lines in turn branching from these main circuits. The territory covered by such plants is so great, and the transmission system so complex, as to call for a departure from the earlier methods developed from telegraph and telephone practice.

It is obvious that the longer the line the more reliable and substantial it must be. A plant transmitting power five miles might be shut down three or four times a year by line troubles without seriously interfering with its service. If, however, there were 500 miles of circuits instead of five, and the same number of accidents per mile occurred, the plant would be shut down every day and the power would be absolutely valueless. Moreover, the longer the transmission line the more difficult it is to locate and correct a fault. On a five-mile line repairs might be made in an hour or two while on a 500-mile system it would probably take a day to find the place and get the plant in operation again.

Existing wooden pole lines have given good results and electric power has proved successful even under adverse conditions and justified the investment of greater capital in larger plants and longer power transmissions.

The same reasons which have led the railroads to replace their wooden bridges with steel structures will ultimately cause power transmission engineers to substitute steel for wood in all important transmission enterprises. The advantages of a steel-tower construction are that it is fireproof, durable and readily admits of structures of a size and strength impracticable with wood. With

higher and stronger supports for the power circuits longer spans can be employed and the number of points of support correspondingly reduced. This fewer number of parts much simplifies the transmission system, both in construction and in operation, and permits of more expensive and reliable designs being used. The wires may be placed much farther apart thus obviating the principal cause of trouble — short-circuits. The insulators may also be larger and better, both electrically and mechanically, and every part of the system can be laid out in advance, the strains calculated and the structures designed with ample factors of safety.

The length of span to use is the most difficult question and the one into which the most factors enter. The calculation of long spans is primarily a suspension-bridge problem in which all the mechanical stresses must be fully investigated.

The strength of the conductor is at least as important as its conductivity and the purpose of this paper is to give the results of investigations, made under the direction of the writer, to determine the characteristics of conductors so as to secure some definite basis upon which to figure long spans. To this has been added other data which must be assumed and the method of calculation followed.

The materials available as conductors are copper, aluminum, iron and steel. The alloys of copper and aluminum have strength but low conductivity and have not been considered in this paper.

#### COPPER WIRE.

Copper wire varies widely in its characteristics depending on the methods used in its manufacture. The copper is received at the wire mill in the form of cast-wire bars weighing 200 to 300 lbs. It is then rolled into rods and the rods are drawn into wire of the required size. The temperature at which the metal is rolled, the reduction of area both in rolling and drawing, and the amount of annealing which the wire is given, all have an important bearing on its characteristics. As the size of the original wire bar is limited, the smaller the wire, the more it is worked and in general the better the result.

Fig. 1 shows stress and strain curves of different kinds of copper wire, made in a Richlé tension machine, which are plotted in terms of pounds per sq. in. and per cent elongation in 60 ins., so that the different wires, although of various sizes, can be directly compared.



*A* is soft annealed wire of .165" diameter; *B* is ordinary half hard wire of .363" diameter; *C* is hardrolley wire of .363" diameter; and *D* is hard-drawn telephone wire of .1646" diameter.

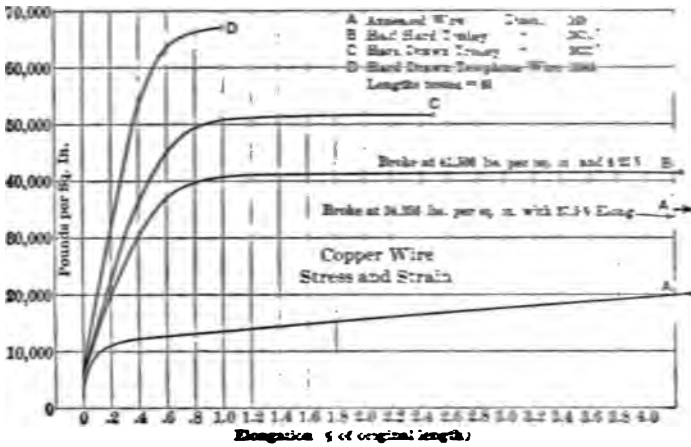

FIG. 1.

It will be noted that the ultimate resistance of these wires varies from 34,350 lbs. to 67,000 lbs. per sq. in., and the elastic limit, which is assumed to be at the point where the stress and strain cease

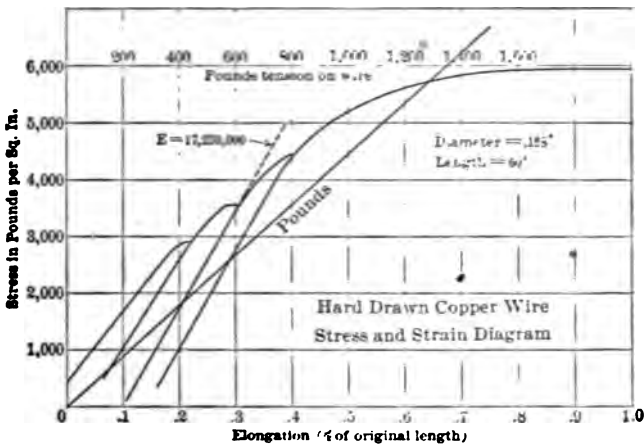

FIG. 2.

to be proportional (the tangent point of the curve), varies from 7000 lbs. to 40,000 lbs. per sq. in. In these curves the read-

ings were made as quickly as possible to prevent the wire taking a set.

In Fig. 2 is shown a diagram of .168" diameter hard-drawn copper wire in which the wire is given time to take a set at certain points. The curve is repeated several times by running up from zero to a higher stress than before, and it will be noted that the wire takes a permanent set at each stress to which it is subjected, and the longer the time the greater the set.

Fig. 3 shows the curve of the same .168" diameter wire given on Fig. 2 that had already been broken in the testing machine at

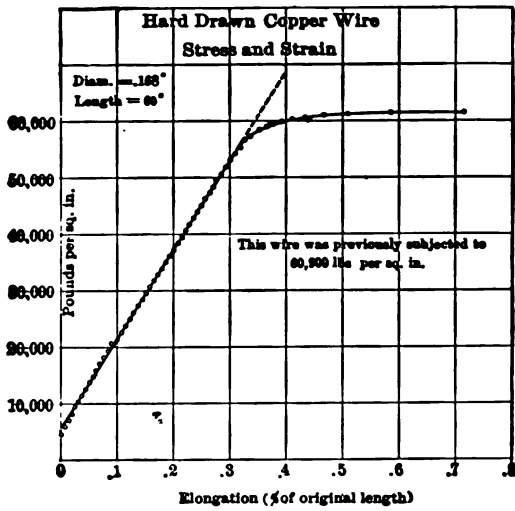

FIG. 3.

60,900 lbs. per sq. in. and consequently had taken the maximum set. In this case the elastic limit, taken at the tangent point of the curve, would be 55,000 lbs. per sq. in., instead of the 35,000 lbs. it had originally, as shown in Curve *D* in Fig. 1. It is evident, therefore, that the actual elastic limit can be made nearer the ultimate resistance by stretching the wire either in drawing it or afterward.

In order to study the effect of time upon the elongation of wire, and to determine whether the wire would continue to stretch and ultimately break at points below the elastic limit, the arrangement shown in Fig. 4 was devised. This consists of jaws to clamp the

ends of the wire so that a weight can be suspended by it. In order to measure the elongation, the copper wire is passed through a

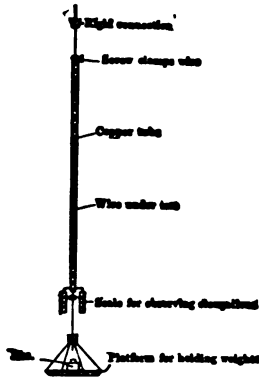

FIG. 4.

copper tube which is clamped to the wire at the upper end. As the tube and wire are of the same material the elongation can be

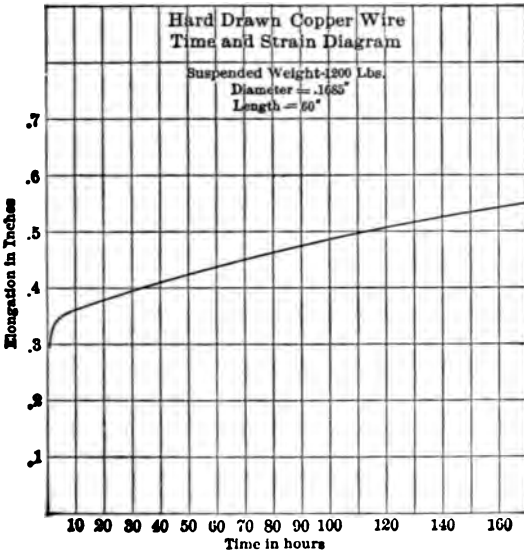

FIG. 5.

measured independently of the changes in the temperature of the room. The wire was then subjected to a stress and the elongation measured at different times.

Fig. 5 is a curve of strain and time upon a 5-ft. piece of the .168" diameter copper wire which was subjected to a stress of 1200 lbs. or 54,000 lbs. per sq. in. for seven days, eight hours, until it broke. This shows that a wire will not stand continuously 90 per cent of its ultimate resistance as pieces of this wire broke again in the testing machine at 61,000 lbs. per sq. in. The elongation shown by the weight test was not materially different from that given by the testing machine in Fig. 5. So far as these suspension tests have gone they indicate that hard-drawn copper wire, which has an elastic limit of 40,000 lbs. per square inch as ordinarily

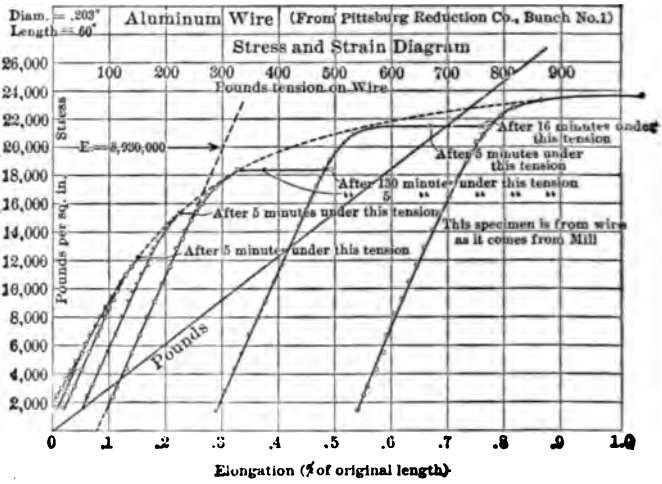

FIG. 6.

tested, will stand continuously about 50,000 lbs. per sq. in., or 80 per cent of its ultimate strength.

ALUMINUM WIRE.

The conditions of manufacture have the same effect upon the characteristics of aluminum as in the case of copper wire. The elongation of hard-drawn aluminum averages about the same as that of hard-drawn copper in the samples tested and the aluminum wire takes a set in the same way as already mentioned in copper.

Fig. 6 is a curve upon aluminum wire of .2037" diameter taken with time intervals to allow the wire to set. The ultimate resistance of the aluminum wire tested averaged about 24,000 lbs. per sq. in., and the elastic limit from 12,000 to 14,000 lbs. This aluminum wire gave 60 per cent of the conductivity of hard-drawn copper

of equal cross-section. The cross-section for equal conductivity must, therefore, be 60 per cent greater than that of copper and the diameter 27 per cent greater. The weight, on the other hand, is about one-half that of copper for equal conductivity.

#### IRON AND STEEL WIRE.

Fig. 7 shows the stress and strain diagram of common soft .1638" diameter galvanized iron telegraph wire. Its resistance was 7.4 times that of copper. The ultimate resistance and elastic limit of this wire are less than that of hard-drawn copper wire.

The elongation (11 per cent), however, is much greater, showing that the iron wire gets its strength from the material rather than from the method of manufacture. It probably was stronger before

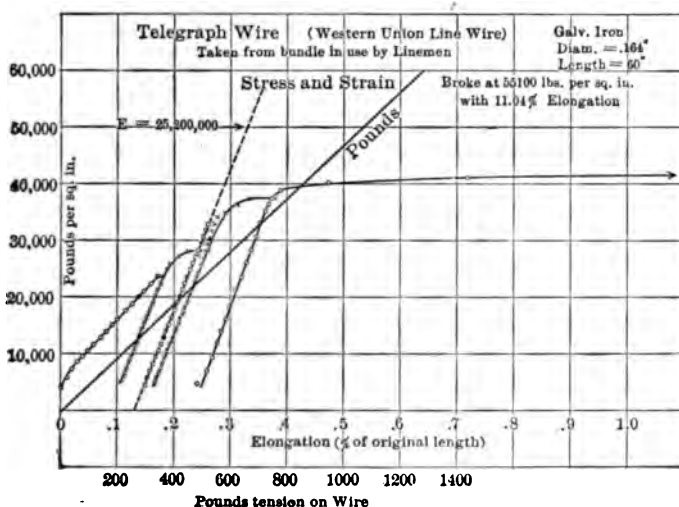

FIG. 7.

it was galvanized which, undoubtedly, drew the temper and reduced the strength.

Tests upon samples of steel wire, made before and after galvanizing, showed that the ultimate resistance was 43 per cent higher before being galvanized and the elongation one-tenth. Iron and steel take a set under stress the same as the copper and aluminum samples.

Figs. 8 and 9 show curves of galvanized crucible steel .109" diameter wire made by the American Steel & Wire Company, which had an ultimate resistance of nearly 230,000 lbs. per sq. in.,

and an elastic limit of about 125,000 lbs. per sq. in. The wire takes a set similar to that shown by other materials. The

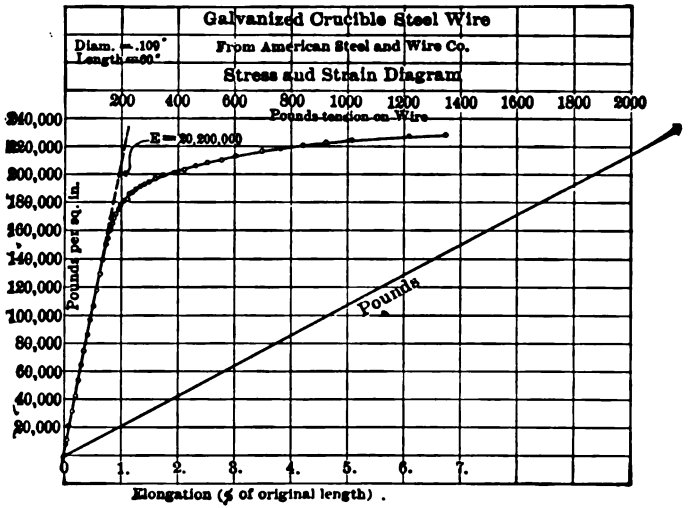

FIG. 8.

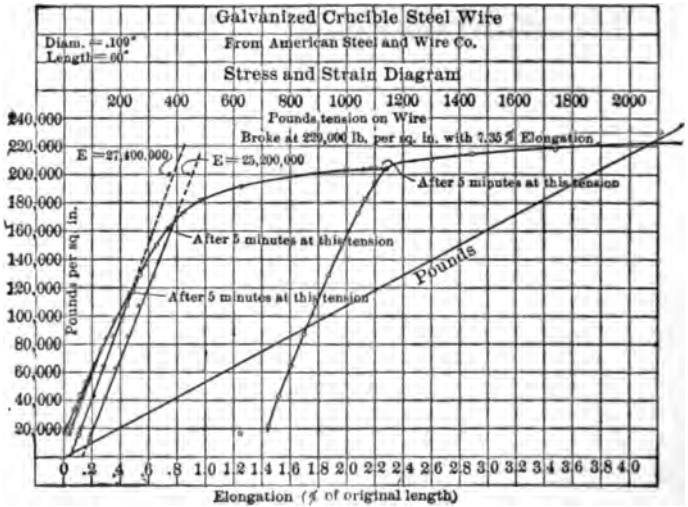

FIG. 9.

elongation is noticeably greater than that of copper. The resistance of this wire was 11.6 times that of copper of equal cross-section

The diameters of these iron and steel wires would, therefore, be from 2.7 to 3.4 times those of copper of equal conductivity.

### CABLES.

Copper cable made up of several strands has the advantage of using smaller wires than a solid conductor and also permits of longer lengths of conductor without splices. Assuming a 300-lb. wire bar, a 19-strand cable for example can be made up weighing 5700 lbs. while if solid wire were used the weight of one piece would be 300 lbs. In other words, there would be 19 times as many joints with the solid wire as with the 19-strand cable. The smaller

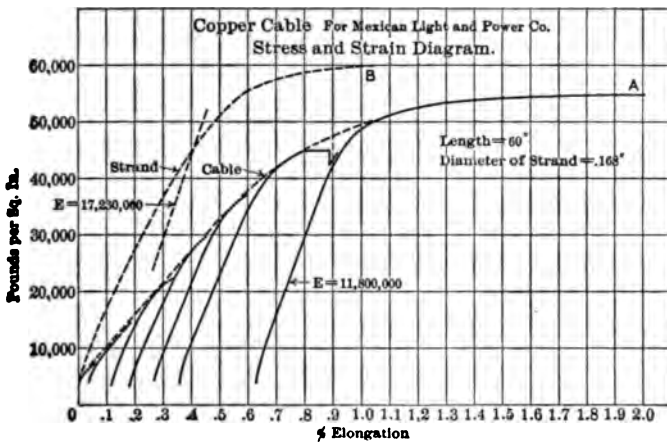

FIG. 10.

the wire and the greater the strength the more brittle it becomes. This is partially compensated for by the greater flexibility of a cable and the fact that a strand can break without the whole conductor parting.

Each strand should be a continuous wire without joints. Joints in the cable should be as few as possible and made by means of twisted sleeves, as brazing or soldering anneals the wire and much reduces its strength.

In Fig. 10, *A* is the curve of a copper cable made up of 6-strand .168-in. diameter wire on a hemp center with three and one-half twists per foot. *B* on the same sheet is the diagram of one of the strands of which this cable is composed. It will be noted that the

cable had but 90 per cent of the strength of the strand but a much higher elasticity and elongation.

The center wire of seven strand cables broke before the outer strands showing that it takes the strain before the other strands on account of its less elasticity. The outer strands are longer and to a limited extent may be considered as spiral springs. It will be noted that the cable is more elastic than the solid strand which is a desirable characteristic in long spans, as will be shown later.

Fig. 11 shows the curve of a galvanized seven-strand crucible steel cable similar to the strands shown in Figs. 9 and 10.

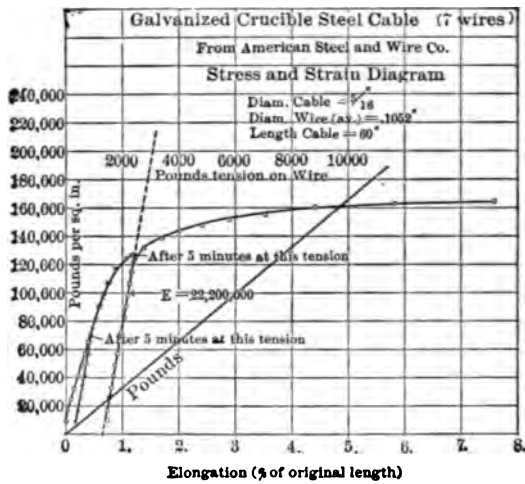

FIG. 11.

It will be noted that the strength of the cable is but three-quarters of that of the strands.

The most serious objection to the use of iron or steel wire is that the galvanizing only protects the wire for a few years and it is, therefore, less permanent than copper.

#### ELASTICITY.

The elasticity of the conductor is of considerable value in reducing the sag when the stress is removed. The elongation of the wire under stress is less after it has once been stretched. The elasticity of cable is greater than that of solid wire, but both wire and



cable take a set under any stress to which they may be subjected. In the following table is given the average modulus of elasticity found for copper, aluminum, iron and steel wire and cable:

Copper hard-drawn wire .....	16,000,000
Copper hard-drawn cable .....	12,000,000
Aluminum hard-drawn wire .....	10,000,000
Aluminum hard-drawn cable .....	7,500,000
Iron galvanized wire .....	24,000,000
Steel galvanized wire .....	27,000,000
Iron and steel cable .....	22,000,000

Each sample was stretched to a point somewhat below its elastic limit before testing. It will be noted that cable is considerably more elastic than the solid wire. The stress and strain diagrams show this. Aluminum is considerably more elastic and has a decided advantage over copper in this respect. Iron and steel are less elastic than either copper or aluminum.

#### COEFFICIENTS OF EXPANSION.

The coefficients of expansion for Fahrenheit degrees are as follows:

Copper .....	0.000,009,6
Aluminum .....	0.000,012,8
Steel .....	0.000,006,4

As the worst condition, so far as sag is concerned, is reached when the conductor is hot, a low temperature expansion is most desirable for long spans, and steel is in this respect better than either copper or aluminum.

#### WEIGHT OF CONDUCTORS.

The relative weight of conductors of different metals for equal conductivity of course depends upon their conductivity for equal cross-section and their specific gravity.

Iron and steel weigh about 86 per cent and aluminum 30 per cent as much as copper of equal cross-section.

The electrical resistance of iron and steel varies from 7 to 12 times, and that of aluminum is 60 per cent more than that of copper. In order to obtain any given conductivity it is necessary to pur-

chase from 6 to 11 times as much iron or steel and but one-half as much aluminum. At present prices of wire, copper is cheaper than iron or steel. If other things besides weight were equal, aluminum would be the best conductor for long spans, as its tensile strength for equal weight is greater than that of copper or iron wire, but less than that of steel. In addition to carrying its own weight, a conductor must also in a cold climate be able to bear the ice which may accumulate upon it in sleet storms.

The writer has assumed that from 1/2 to 1 in. of ice may cover the surface of the wire. In addition, the effect of wind must be considered, not only upon the conductor alone but also on the ice which may be on the wire. Where a large amount of power is being transmitted considerable energy is dissipated in the conductor and the temperature of the wire will be kept above that of the atmosphere and sleet will not form on the conductor.

#### WIND PRESSURE.

The greatest stress in the wire is caused by wind pressure. This is generally assumed in engineering structures to be 40 lbs. to 50 lbs. per sq. ft. or flat surface with a wind velocity of 100 miles per hour. Forty pounds is undoubtedly ample to allow for, as higher pressures are only obtained on limited areas and the average pressure on a long span would be much less than the maximum. It is also improbable that the highest wind would be exactly at right angles to the line. Ice on the wire will also break off more or less with high winds. Small conductors suffer more from wind and sleet than larger ones, as the exposed surface varies directly as the diameter, while the cross-section and, consequently, the strength increases as the square of the diameter. A given thickness of ice on a wire is evidently a heavier load on a small than on a large wire. It is, therefore, most undesirable to employ small conductors for power transmission. On a cylindrical surface a given wind velocity only causes half the pressure that it does on a flat surface, so that the maximum pressure on a conductor can be taken at 20 lbs. per sq. ft. The less the diameter of a conductor for a given conductivity the better, so far as wind strains are concerned.

As aluminum wire must be 27 per cent greater in diameter and iron and steel from 2.5 to 3.5 times the diameter of copper, they compare unfavorably with the latter in this respect.

SPAN AND SAG.

In calculating the sag in a conductor for any span, the maximum stress which can be permitted in the wire must first be assumed. This should be the elastic limit of the wire with a factor of safety. The maximum side strain per foot of conductor is the resultant of the weight and wind pressure which are at right angles to each other. If there is sleet, the weight of the ice and the wind effect upon the increased diameter of wire due to ice must be allowed for.

The maximum sag may be due to the conductor being loaded with sleet or to heating of the wire in a hot sun. The latter will generally be found to give the greater sag. Owing to the conductor being elastic, it is not necessary to consider the greatest deflection

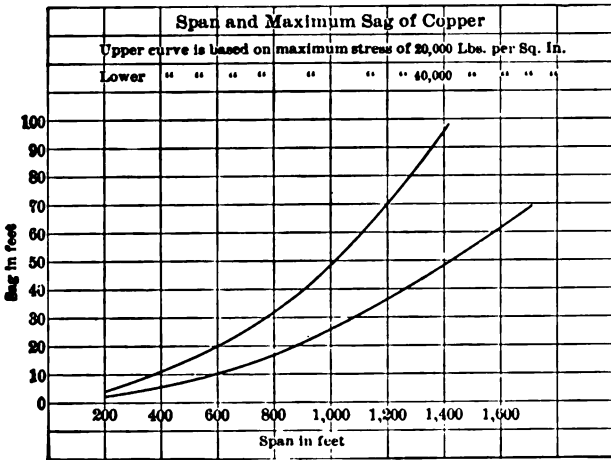

FIG. 12.

from a horizontal line between supports as the vertical sag of the wire. The wind pressure causes the wire to swing to one side, and it is elongated by the combined strain of wind and weight; but as soon as it is relieved of the wind pressure it swings back to a vertical position and contracts to the length required to carry its weight alone. The sag due to heating of the wire is also somewhat less than it otherwise would be, because when expanded the strain is less and the wire contracts.

The extreme variation of temperature of the air in cold climates is about 150 deg. F., while further south it does not exceed 100 deg. F. To this must be added something for a conductor exposed

to a hot sun. There is no data upon this, but a total variation in the temperature of the conductor of 175 deg. F. should be sufficient in any country.

CURVES OF SPAN AND SAG.

The attached curves of span and sag are taken from a paper presented by the writer before the American Institute of Electrical Engineers on June 22, 1904, as are also the following calculations:

The curves in Figs. 12 and 13 show the span and maximum sag of copper and aluminum cables at the elastic limit and also at one-half the elastic limit. They do not allow for ice on the wires

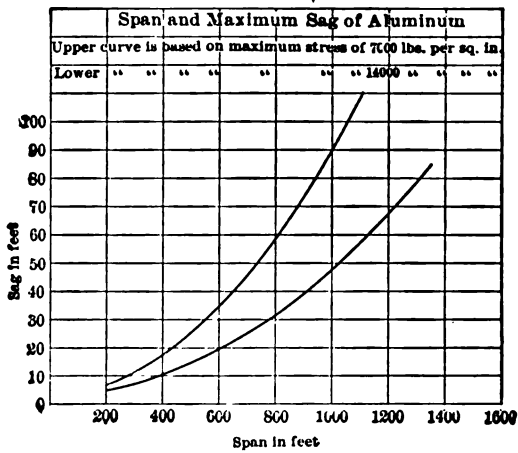

FIG. 13.

and are of value only for the particular diameter of conductor, and under the conditions and data assumed which are as follows:

	Aluminum.	Copper.
Area 6-strand cable . . . . .	0.21 sq. in.	0.132 sq. in.
Diameter 6-strand cable . . . . .	0.59 in.	0.51 in.
Weight per foot . . . . .	0.240 lb.	0.509 lb.
Elastic limit . . . . .	14,000 lb.	40,000 lb.
Stress at 1/2 elastic limit . . . . .	1470 lb.	2640 lb.
Stress at elastic limit . . . . .	2940 lb.	5280 lb.
Wind pressure per sq. ft. . . . .	40 lb.	40 lb.
Wind pressure per ft. cable . . . . .	0.98 lb.	0.84 lb.

Coefficient of expansion .....	0.000,013	0.000,009,6
Variation in temperature .....	150° F.	150° F.
Modulus of elasticity .....	8,000,000	16,000,000

The equations from which the curves were calculated are given below and alongside of them is an example of a 1000-ft. copper span.

$$D = \frac{S^3 \times W}{8 T} = \frac{1000^2 \times 0.98}{8 \times 2640} = 46.4 \text{ ft.}$$

In which  $D$  = deflection in ft.

$S$  = span in ft.

$W$  = resultant of weight and wind in lb. per ft. of cable.

and  $T$  = stress allowed in cable in lbs.

$$L = S + \frac{8 D^2}{3 S} = 1000 + \frac{8 \times 46.4^2}{3 \times 1000} = 1005.74 \text{ ft.}$$

In which  $L$  = length of cable, cold.

$$L_0 = \frac{L}{1 + \frac{F}{E}} = \frac{1005.74}{1 + \frac{20,000}{16,000,000}} = 1004.38 \text{ ft.}$$

In which  $L_0$  = length of cable without stress,

$F$  = lb. per sq. in. permitted in cable,

and  $E$  = modulus of elasticity.

$$L_H = L_0(1 + C B) = 1004.38(1 + 0.000,000,9 \times 150) = 1005.81 \text{ ft.}$$

In which  $L_H$  = length of cable, hot (150 deg. F. rise in temperature),

$C$  = coefficient of expansion,

and  $B$  = maximum degrees F. rise in temperature.

$$D^2 + \frac{3 S}{8} (S - L_H) D = \frac{3 S^3 L_H W}{64 E A}$$

$$D^2 + \frac{3 \times 1000}{8} (1000 - 1005.81) D = \frac{3 \times 1000^3 \times 1005.81 W}{64 \times 16,000,000 \times 0.132}$$

$$D^2 - 2178.7 D = 22,323 W.$$

In which  $A$  = area of cable.

From this equation any deflection of the cable can be assumed and the corresponding weight calculated. For instance, in the example if  $D = 48.8$  ft.,  $W = 0.51$  lb.; that is the sag hot, without wind, is 48.8 ft., which is the maximum vertical deflection under the conditions assumed.

If  $D = 51.1$  ft.,  $W = 0.98$  lb. which is the maximum deflection with wind but this is at an angle of 31 deg. from the horizontal and the vertical sag is only 26.6 ft.

## DISCUSSION.

Chairman SCOTT: We are fortunate in having with us Mr. Robert Kaye Gray, President of the British Institution of Electrical Engineers, and as I believe this is in his professional line, we will be very pleased to have him open the discussion.

President GRAY: Well, gentlemen, in talking about the conductors and the use of aluminum, we have, as you are all aware, not very much experience in England, but after hearing what Mr. Buck has said, I think that there is one point of very considerable interest and that is with respect to the joint. I understood he is employing the stranded cable, but I did not catch very clearly the manner in which the two ends were lined and joined together. Is the strand a 7-strand or a 19-strand? And do you make a long splice? I do not want to ask anything that you do not feel at liberty to tell us.

Mr. BUCK: It is a 19-strand. Each strand is wound around the core separately.

President GRAY: I am very much obliged to Mr. Buck for this information. Your description has been exceedingly clear, and I cannot add anything to the discussion.

Chairman SCOTT: Mr. Buck's paper is valuable for two points. One is the comprehensive statement he has given regarding the characteristics and use of aluminum conductors; the second is the valuable data which he has given from the beautiful and extensive tests which he has made. I regard his contribution as one of very considerable engineering value. He has set an excellent example in taking this problem, which has been so much discussed, and evolving a very simple and direct way of getting the very valuable data which are required. We have with us this morning, in addition, gentlemen who are connected with the manufacture of aluminum and aluminum wire, and engineers who have been using aluminum conductors in their work in the West; also other engineers who have given the matter general consideration.

Mr. P. N. NUNN: It seems to be generally understood that the deflections of aluminum conductors are greater than those of copper. This is not usually true. While the coefficient of expansion of aluminum is greater than that of copper, so also is its elasticity, and these two factors of deflection work oppositely. Moreover, the difference in elasticity is greater than that in expansion. If the commercial aluminum wire now used, and medium drawn copper, be erected sufficiently tight so that at minimum temperature the respective tensions slightly exceed the elastic limits, then the conductors will slightly "draw" without apparent injury, and minimum feasible deflections will at all times be secured. A range of temperature greater than 120° or 130°F. is seldom found at more than a few successive spans. Under these conditions, the deflections of aluminum in even short spans, at moderate temperatures, will be less than those of copper, while in spans of over 200 feet, they will be less at all temperatures.

Mr. BUCK: In regard to the question of taking into consideration the modulus of elasticity and the coefficient of expansion, I want to say that they were both included in these calculations, and if we have any confidence in mathematics, there is no reason to doubt that the deflection of aluminum will be greater than for copper at the hypothetical high tem-

perature of 150° Fahrenheit. If you do not include wind pressure, aluminum starts with a very much lower initial deflection at minimum temperatures; but as the temperature rises, the aluminum overtakes the copper and passes it; so that at the highest temperature the deflection is considerably more.

Mr. P. M. LINCOLN: I think possibly there is one element which has not been taken into consideration in either Mr. Nunn's discussion or Mr. Buck's, and that is that the supports in any transmission line are not absolutely rigid; they are flexible to a considerable extent; and as the tension decreases by elevation of temperature, this elasticity of the supports will come in and take up a considerable portion of the sag which would otherwise occur. That possibly may be the reason for Mr. Nunn having noted a smaller sag with aluminum than with copper. There is one question which I would like to ask in regard to Mr. Buck's paper, and that is what causes this difference between indicated wind velocities and actual wind velocities? I did not realize that such a large difference obtained.

Mr. BUCK: The Government anemometer, as you know, is made of a series of cups. One side of each cup is convex and the other concave. The concave side offers more resistance than the convex; so that the anemometer rotates in that direction. At low wind velocities the relation between those two resistances has a certain value. As the wind velocity increases, that relation changes; so that the anemometer rotates faster, relatively, at high wind velocities than it does at low velocities and the correction factor increases. Why it does is a physical matter, that I will not venture to explain.

Mr. R. S. HURTON: About everything that Mr. Buck has brought out we find quite true out on the Coast. Of late we have been going to the long-span proposition. Most of our transmission lines run through a mountainous country and we cross some very deep gulleys. These have given us excellent opportunities to try long spans, and we have some, of aluminum wire, as great as 1800 feet. At first it was thought that we would have to give the wires very great separation. We started in, however, with a medium spread of wires, and found that during the wind storms, owing to the great weight of these spans, and the low periodicity of the natural vibration, they all swing together, so that they are practically parallel at all times. It therefore appears that there is very little possibility of their ever crossing in a wind storm, and we have yet to experience a single case where any of our long spans have ever crossed in a wind storm, and we have had some as high as 72 miles an hour, according to the records of the Weather Bureau.

Chairman SCOTT: The element in a transmission line which is next in importance to the conductor, is the insulator. There is probably no element in the general branch of high-tension transmission upon which more is involved, and upon which more depends and, on the other hand, to which more attention has been given and a greater variety of product has been produced than in high-tension insulators. One of the men who has had to do with high-tension work in some of the earliest and most important high-tension plants and has made a special study of the insulator, is Mr. Converse, who will now present a paper on that subject.

## HIGH-TENSION INSULATORS.

BY V. G. CONVERSE.

It is only 14 years since 3,000 volts was considered a very high tension, and the success of a transmission at this tension was looked upon with far more skepticism than we attach to one of 80,000 volts at the present time. As the steps in high tension have been made with the increasing use of alternating currents, and as alternating-current power transmission dates back but the 14 years mentioned, the province of this paper may then be considered to be within these limits.

It is a little difficult to trace the early stages in the development of the high-tension insulator. Undoubtedly the first forms were copied from insulators used for telegraph and telephone work. Certain it is that the same styles of insulators were proposed, and the same theories were advanced. As the tension or voltage increased, the insulators were made larger and had various petticoats in order to prevent the leakage of current. Since it was found in telegraph work that if the surface of the material of the insulators was hygroscopic there was difficulty in transmitting the message, the materials of high-tension insulators were very carefully considered, in order that this dangerous hygroscopic condition might not so reduce the effectiveness of the insulator that vital quantities of current would leak over the surface. The same constructions for cross-arms, pins, and the securing of insulators, adopted by the telegraph and telephone companies, were appropriated for power transmissions, and until a few years ago the aim has been to use such details of construction as had become standard and thus could be easily obtained.

Glass and porcelain are the only materials which have been used extensively for high-tension insulators, although many other materials and compositions have been proposed and tried. At times it has seemed as if one possessed qualities of decided advantage over the other, but a better understanding of the requirements, or an improvement in the method of manufacture, has brought



**the other to an apparently equal basis, so that from the first we have had glass insulators and porcelain insulators, and even combinations of glass and porcelain.**

The commercial success of high-tension transmissions having been until late years in doubt, developments of insulators have been in the improvement in form and materials, no radical changes in construction being ventured, yet every engineer has had his own ideas regarding the details of construction. It would seem as if almost every engineer who has had the opportunity of exploiting his ideas has done so. As a result, we have had at various times insulators with gutters and spouts, insulators in the form of helmets, some with drip points, and others with every conceivable form and combination of petticoats. The situation has been further complicated by a variety of ties for securing the line to the insulator, pins of wood and of iron, various threads for securing the insulator to the pin, and even by a wide range of colors of material. It is little wonder that the manufacturer of porcelain or glass who was skilled in the art of making table-ware and various other utensils, and perhaps telegraph insulators, has hesitated when confronted by the requirements of the up-to-date high-tension engineer.

Now it should be stated to the credit of the manufacturer that the arts of making porcelain and glass, which have descended to us from periods antedating the Christian era, had reached a certain stage of perfection. Strong and beautiful and satisfactory wares were made, but here was a new requirement. The material of the insulators must be strong to withstand mechanical strains, and it must also withstand the unseen and unknown electrical forces which tend to break it and render the insulators useless. The improvements which have been made in glass have been in the direction of strengthening the quality in order to protect against mechanical breakage, the structure of glass already suiting electrical conditions very well. The improvements in porcelain, which have been in the direction of strengthening the body of the material to resist electrical puncture, have been interesting and are noteworthy. From porcelains, which were first furnished for insulators and would stand but a few thousand volts—perhaps these few thousand volts going farther through the body of the porcelain than if no material whatever were interposed—the advance has been in the line of obtaining a more homogeneous, refractory and vitreous grade of material which is strong in resisting electrical breakage. Of recent years the combining

of layers of this high-grade electrical porcelain has further strengthened the body of the insulator.

But let us trace directly the forms of insulators which have been used. In 1890, the first alternating-current power transmission in the United States used for 3,000 volts a glass insulator of the form shown in Fig. 1. This is an insulator such as is



FIG. 1. TELEGRAPH INSULATOR.

commonly used by the telegraph companies, and is only about 3 in. in diameter. In spite of the predictions that the insulator would not suffice, the plant continued in operation for six years without insulator troubles.

For the famous Frankfort-Lauffen transmission experiments in Germany in 1891, a porcelain insulator with an oil cup was used. No definite information as to the exact shape of this insulator is at hand, but the principle was probably not unlike that of the insulator shown in Fig. 2. Voltages as high as 28,000 to 30,000

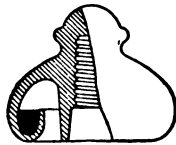

FIG. 2. OIL CUP INSULATOR.

were used in these experiments for a limited time. Insulators with oil cups of various forms appeared very shortly afterwards in England and the United States. If the insulator was of glass, the outer petticoat was usually curved inward and up, so as to form an internal groove which would hold oil. A common form for porcelain insulators was to bring down a petticoat from the body of the insulator which would dip into a cup of oil, the cup being made in a circular form and held in place around the pin by a support on the pin. Insulators with detachable oil cups were supplied for the 10,000-volt transmission at Pomona and San Bernardino, Calif., started in 1892. The oil cups were not used, however, as they were found to be unnecessary.

Insulators without oil cups being equally effective as those with oil cups, a form similar to that shown in Fig. 3, made of either

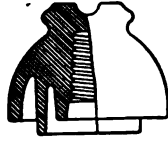

FIG. 3. TRIPLE-PETTICOAT INSULATOR.

glass or porcelain came into use. Here the idea was to impede the leakage of current over the surface by introducing petticoats which gave a very long surface between the conductor and the pin. Some insulators had as many as four or five such petticoats.

No further increase in voltage is noted until 1895, when we find the Hochfelden-Oerlikon transmission in Switzerland at 13,000 volts. In 1897 we had transmissions in the United States at 16,000 volts.

About this time it was found that porcelain insulators which had been formed and pressed in iron moulds had not a sufficiently compact or homogeneous structure and were apt to be punctured in service. A study of the matter showed that really the only effective dielectric insulation of the porcelain was contained in the glaze over the surface of the porcelain. In some cases it was found that the interior body of the porcelain insulator would actually absorb and hold a considerable quantity of water. The manufacture of porcelain was then studied with a view to overcoming these difficulties. The method was resorted to of making the insulator in several thin shells which were glazed separately

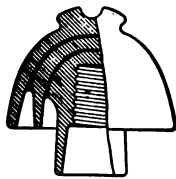

FIG. 4. "GLAZE-FILLED" INSULATOR.

and then glazed and fired together, the potter's wheel being reverted to in order to make the shells of sufficient compactness. This construction is shown in Fig. 4. It will be noted that a petticoat is here extended down for a distance over the pin for the purpose of further insulating from the pin. Attempts had

problem for voltages as high as 40,000 has been satisfactorily solved.

We are now to the point of considering the very highest-voltage insulators—those which are in use for voltages from

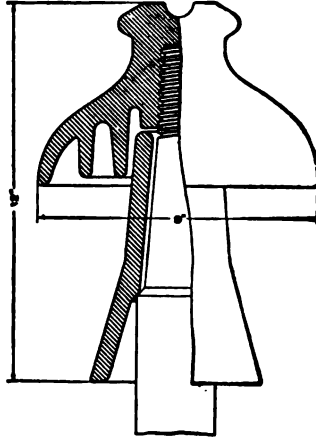

FIG. 8. MISSOURI-RIVER INSULATOR.

50,000 to 60,000. Fig. 8 shows a glass insulator used by the Missouri River Power Company in Montana, for 55,000 volts. This insulator has been in service since 1901. The insu-

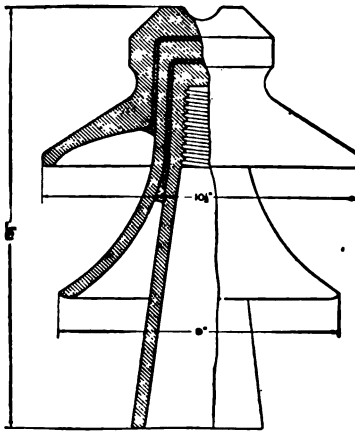

FIG. 9. SHAWINIGAN-FALLS INSULATOR.

lator is in two parts, one a hood 9 in. in diameter, and the other a sleeve set over the pin. The sleeve, which is open at

the top, adds nothing to the dielectric strength of the insulator, its purpose being to protect the wooden pin. Obviously the sleeve would be of little value if a metal pin were used. This type of insulator possesses the advantage of being in two parts which are separable, either of which can be replaced if broken.

The insulator used for the 50,000-volt transmission at Shawinigan Falls, Que., is shown in Fig. 9. This is of porcelain and made in sections. Each section has a closed top and adds to the dielectric strength of the insulator. Two petticoats, one 9 in. and the other 10 in. in diameter, extend outward and give the effect of one insulator over another. One section extends down around the wooden pin and serves to protect the pin. The sections are held together with Portland cement. This insulator

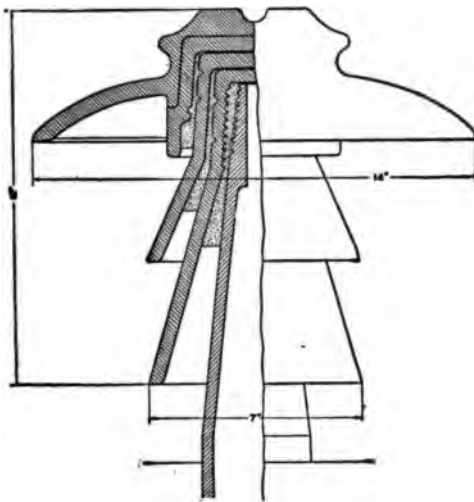

FIG. 10. GUANAJUATO INSULATOR.

shows the combination of the sleeve around the pin, outwardly extending petticoats and of sections, as first indicated in Figs. 4 and 5.

Fig. 10 shows a very large and extended form of the mushroom type, which has recently been put into use on the 60,000-volt transmission at Guanajuato, Mexico. The top section is 14 in. in diameter. The sections are secured together with Portland cement, and the whole is cemented to a hollow metal pin.

For several transmissions under construction for voltages between 50,000 and 60,000, the insulator shown in Fig. 11 has been adopted. Some of these insulators exceed 14 in. in diameter and weigh as much as 25 pounds.

Actual insulators are used which are similar to those used in this country. It is probable, however, that they have not been made in such large sizes, also that corresponding sizes are used for lower voltages.

The present highest-voltage insulators, then, of which the writer knows, and which may be considered as representing the most

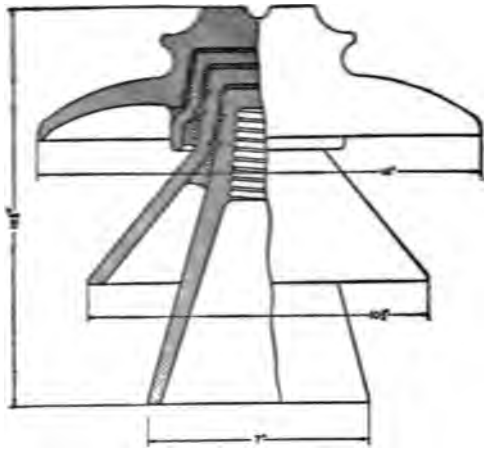

FIG. 11. TYPE ADOPTED FOR SEVERAL TRANSMISSIONS UNDER CONSTRUCTION.

advanced state of the art in insulator design and construction are represented by Figs. 8, 9, 10 and 11. Whatever advantage one may possess over the others will doubtless be shown in course of time.

Compare now the telegraph insulator, which was used as the first high-tension insulator, with these large ones. Our high-tension insulator has grown with increasing voltages from one weighing a pound or two to one weighing 25 pounds, and from 3 in. to 14 in. in diameter, and in cost from a few cents to several dollars.

We naturally begin to wonder what the future development in insulators will be. Will they continue to increase in size and in weight? If so, we can easily imagine that when an insulator

which is 14 in. in diameter and weighing 25 lbs. is required for 60,000 volts, 80,000 volts might require an insulator 20 in. in diameter and weighing 50 pounds. Further development along this line brings to our imagination insulators which will look not unlike Chinese pagodas and weigh perhaps several hundred pounds, as has been predicted.

This development appears ridiculous when we consider such structures made out of fragile materials like glass or porcelain, yet it is believed that much higher voltages are to be used in the future. Even now we find one company in the United States equipped in every way, except the insulators, to transmit at 80,000 volts. We note also that the largest power development in progress of construction is providing to receive apparatus for 80,000 volts, the amount of power in this case being so large, it has not been considered that it could be always marketed within the range of territory to which it may be economically transmitted at less than 80,000 volts.

Another factor which is tending to make insulators heavier is the steel tower construction for supporting the lines. This construction means longer spans and hence heavier and stronger insulators. Some relief may be given the insulators on these towers by housing them over to protect them from the elements. Some slight advantage may also be gained by securing the wire to the under portion of the insulator, rather than on top of the insulator, as is now done.

It would seem, however, that the trend of development in high-tension transmission would continue along the lines which have become established. In favor of the further increase in voltage, it must be remembered that there is always the possibility of the discovery of some new insulating material which is superior to glass and porcelain; and even much improvement may be expected in glass and porcelain themselves. While a remarkable improvement has been made in the dielectric strength of porcelain, it is only at the present day that its possibilities are beginning to be realized. Likewise with glass we may expect a complete revolution in the method of manufacture, the art of making glass insulators having been given less thought, and is probably much less advanced than the art of making porcelain insulators.

The requirements for a high-tension insulator may be enumerated as follows:

1). The material must have a high dielectric strength; in other words, it must be strong to resist puncture by the current. In order to fulfill this condition, the material must be continuous, compact and homogeneous, even the most minute crack or fracture being a weakness.

2). There must be sufficient resistance over the surface of the insulator so that there will be no considerable conduction or leakage of current.

3). The distance around the insulator between the wire and the pin or support must be sufficient to prevent the current from arcing.

4). The second and third requirements are dependent upon the shape of the insulator. Its contour must be such that there will be unexposed surfaces which will not get wet or accumulate dirt, salt, etc., as these materials are conducive to leakage and tend to lessen the arcing distance. Evidently the requirements which are dependent upon climatic conditions vary with the locality in which the insulators are to be used. If in a country which is not subjected to heavy rains, sleet or dust storms, the insulator may perhaps be smaller than an insulator required in a locality where the climatic conditions are severe. Usually a larger type of insulator is required for the same voltage in a cold country than in a warmer climate. This may explain why some insulators which have been very satisfactory under a given voltage in one locality have utterly failed when tried at the same voltage in another place. In some localities, particularly on the Pacific coast, the accumulation of salt is so great from the so-called salt fogs that it has been found necessary to have the unexposed surfaces rather shallow and with few petticoats in order that the surfaces be readily accessible for periodical cleaning.

5). The shape and arrangement of the petticoats should be such that the electrostatic capacity of the insulator will be small.

6). The internal heat losses from conduction and hysteresis should not be such as to appreciably heat the insulator.

7). Mechanical requirements, such as strength, mounting, method of fastening the wire, color, etc., are in general, dependent upon the conditions to be met.

It does not seem as if details like gutters, spouts, drip points and the like can be considered of much value. They are features which may look well in theory, but can cut little figure in practice. Certainly the insulation of our high-voltage lines is more



dependent upon a good, strong insulator with liberal margins of safety, than upon such refinements.

The following tests are advised in order to determine whether insulators will meet the requirements:

1). In order to determine dielectric strength, porcelain insulators should be inverted, with their heads dipping into salt water, the solution extending well over the head of the insulator. The hole for the pin should also be filled with salt water. The predetermined voltage for testing may then be applied to the two salt solutions. Usually a voltage test of several minutes is made. The defective insulators will be punctured in this manner. If the porcelain insulators are made in several sections, the purpose of the sections being to obtain greater dielectric strength, then the sections should be tested individually in the same way. When the sections are cemented or assembled to complete the insulator, it is advised to again test, using the same method, in order to be certain that the sections have not been broken. Every porcelain insulator of a lot should be tested in this manner.

If the insulators are of glass it is best to have every insulator tested in the manner described for porcelain insulators, but as the defects in glass are easily visible it may be necessary to test only a few of a lot in order to determine the strength of the glass, the remainder passing the rigid examination of an inspector who will discard such insulators as have cracks, air bubbles, or less than the required thickness.

2). The measurement of leakage over the surface of an insulator is an extremely difficult thing to accomplish, and the refined methods which are required are not applicable to factory tests of a large number of insulators. Any leakage of account will be observed in the test for dielectric strength, either by the visible creepage of the current over the surface, or by the heating of the insulator.

3). A lot of insulators having passed a preliminary inspection, it is necessary to test only a few in order to meet the third requirement. These may be set up as in service and the predetermined voltage applied. It is customary to apply the voltage to the line and pin. It is further advised that a voltage be applied across two insulators mounted in the same way, in order to duplicate as near as possible normal running conditions.

4). In order to test for the effectiveness of the contour of an insulator, it is necessary to imitate as nearly as possible the most

severe climatic conditions under which the insulator is to operate. Tests of this kind have not been extended farther than to obtain the effect of a heavy driving rain. An insulator mounted as for use should have a broken spray of water thrown upon it at an angle but slightly above the horizontal. The results with this combination may then be noted with a predetermined voltage applied between line and pin, or between two insulators similarly treated.

The value of tests should not be overestimated, for it will be recognized, especially as to dielectric resistance, that no laboratory or factory test of the dielectric strength of insulators can approach the time test of insulators in actual service. Consequently it is well to allow a wide margin of safety over the actual requirements. Wide margins of safety in every particular is also good practice in order to compensate for the abnormal voltages which are characteristic of high-tension transmissions. It is questioned whether there is any other element of a high-tension power transmission which operates on such narrow margins as the insulator. Especially is this true in America.

Unfortunately with very high tensions, we are apparently nearing the point where the question is whether there is any margin possible, rather than how much. For a better understanding of the situation, the writer will review the conditions as he has found them.

The electrical requirements of a high-tension insulator are at variance with the requirements for mechanical strength in the following respects:

- 1). In order to increase the dielectric strength, reduce the capacity and lessen the brush discharges, it is necessary to increase the thickness of the head of the insulator. As the thickness is increased, the pin or support in the insulator is removed farther from the strains of the wire and mechanical stresses are brought upon the insulating material which it is incapable of withstanding. Especially is this true if the wire is tied or supported on the top of the insulator.

- 2). If the point of support of the wire is lowered to the side of the insulator, it is necessary that the insulator be of large diameter at the point of support in order to have the required dielectric thickness. Also with the wire on the side of the insulator, the surface distance is decreased and the length of the adjacent petticoat must be correspondingly increased.

- 3). No logical or safe arrangement has ever been proposed

THE NEW YORK  
PUBLIC LIBRARY  
ASTOR, LENOX  
TILDEN FOUNDATIONS



FIG. 13.— EXPERIMENTAL INSULATOR UNDER TEST AT 198 KILOVOLTS.

whereby all the lines of a circuit can be supported otherwise than on the tops of the insulators. In this position the surface of the insulator is exposed to the elements, at least as far as the edge of the extending petticoat adjacent to the line, and the effect is to aggravate the cause for leakage for a certain distance, where it must be checked.

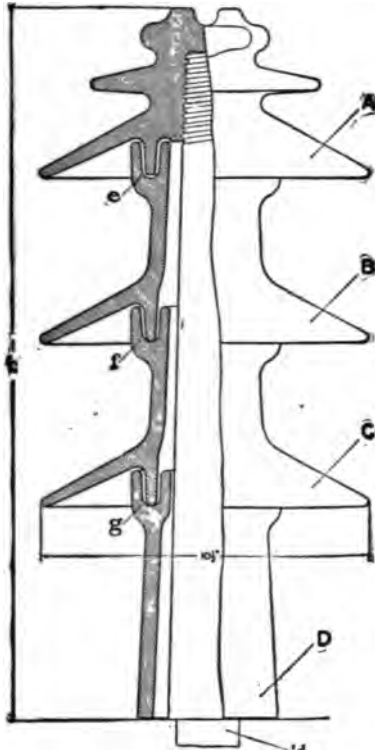

FIG. 12. EXPERIMENTAL HIGH-TENSION INSULATOR.

4). The requirement for a larger insulator means one which is more breakable—if of glass, one apparently beyond the present knowledge of how to mould, or how to anneal.

The electrical requirements are also contradictory in this respect—a larger insulator for increasing the arcing distance adds but little resistance to leakage and probably increases the capacity.

The writer early foresaw the objections to making insulators of constantly increasing diameters for increasing voltages, and proposed the making of insulators in parts and with outwardly extending petticoats. Such construction is shown in Fig. 12. Other

# THE CONSTRUCTION AND INSULATION OF HIGH-TENSION TRANSMISSION LINES.

BY M. H. GERRY, JR.

There are in America at the present time, about ten systems operating regularly at tensions of not less than 40,000 volts, and transmitting energy from sixty to one hundred and fifty miles. Two of these transmissions employ pressures of between 50,000 and 60,000 volts. The above mentioned systems have all been constructed within the past decade, and while they represent commercial enterprises of considerable magnitude their chief interest lies in the possibilities which they suggest for future developments. The following paper briefly discusses the problems connected with the construction and insulation of transmission lines without touching upon the generation of the high-tension current or its manipulation within the generating or receiving stations. The methods of construction and details of design described are drawn entirely from American practice. The term "high tension" where used refers to electrical pressures such as mentioned above.

## GENERAL DESIGN.

In the construction of high tension transmission lines wooden poles have been used for supporting the conductors almost exclusively, but there is a tendency at the present time to substitute metal, and the more permanent material will doubtless be employed in the future wherever the undertakings are of sufficient magnitude to justify the larger investment. Excellent results have been obtained, however, from the lines now in operation, and the current practice may be followed with a certainty of satisfactory performance and reasonable cost of construction.

Many of the transmission systems are located in a mountainous country difficult of access, and the obstacles overcome have been numerous and varied. Whenever the nature of the service is im-

portant a private right-of-way has usually been secured and two lines of poles erected.

Cedar poles are used in the majority of cases, but redwood, pine and other woods are also employed to some extent. Cedar has an advantage over the other common woods in that it will last longer in moist ground. The pole tops and butts are frequently treated with coal-tar, or some preservative compound, but this practice is not universal. Poles for important transmission lines are usually selected with care, and are heavier and of better timber than those for other classes of service. They are of lengths varying from thirty-five to seventy-five feet, with diameters at the tops of from eight to fourteen inches.

For conductors both copper and aluminum are employed. Copper is used as a solid wire in the smaller sizes, and as a stranded cable when of considerable dimensions. Aluminum is now always employed as a stranded cable. With either metal the flexibility, elasticity and strength are improved when in the form of a cable. Copper may be obtained either soft or hard-drawn. The hard-drawn material has greater tensile strength than the soft or annealed, and for that reason is often preferred. Copper conductors should not, however, be subjected to a greater strain in service than the limit of safety of the soft metal, for the reason that the hard-drawn material may be annealed locally, either during erection while making connections, or while in service by the heating of a joint, or from a short circuit. Aluminum is much the lighter metal for equal conductivity, and this is of some advantage during construction. On account of the greater coefficient of expansion of aluminum, more attention is necessary to temperature conditions at the time of erection, so as to limit the sag and resulting stress developed. Equally good results may be obtained, however, with either metal if properly installed.

The cross-arms in use on most transmission lines are either of fir, or of long-leaf yellow pine. Selected timber is usually employed, and the cross-arms are of special dimensions for this service. In the future structural steel will probably be used to a considerable extent for this purpose.

The pins supporting the insulators are made either of wood or of metal. Of the various kinds of wood, locust, oak and eucalyptus are most in use. Mountain locust from old trees is perhaps the most satisfactory, but is difficult to obtain. Oak if well seasoned

gives good results, and eucalyptus has some excellent qualities. Metal pins are made of steel or cast iron. Steel pins are the most reliable, as they are not subject to flaws, and do not fail from internal strains.

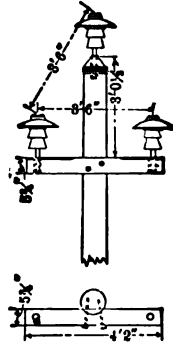

FIG. 1.— POLE TOP FOR HIGH-TENSION TRANSMISSION LINE, WASHINGTON WATER POWER COMPANY.

For fastening together the poles, cross-arms, braces and pins, through bolts are now usually employed.

Various details of construction from current practice are shown in the examples to follow.

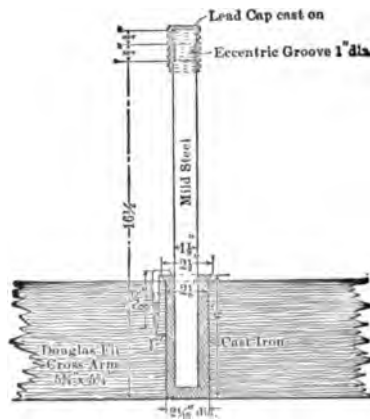

FIG. 2.— STEEL PIN, WASHINGTON WATER POWER COMPANY.

The standard pole construction of the Washington Water Power Company is shown in Fig. 1. This company has recently completed an important transmission, one hundred miles in length, designed



for an ultimate tension of 60,000 volts, although now operating at 40,000 volts. The conductors are of No. 2, B. & S. gauge, medium

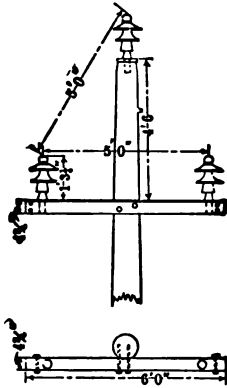

FIG. 3.—POLE TOP FOR HIGH-TENSION TRANSMISSION PLANT, SHAWINIGAN WATER & POWER COMPANY.

hard-drawn, solid copper wire. The insulators are of porcelain and are brown glazed. The distinctive features of this construction are the short distance of forty-two inches between conductors, and

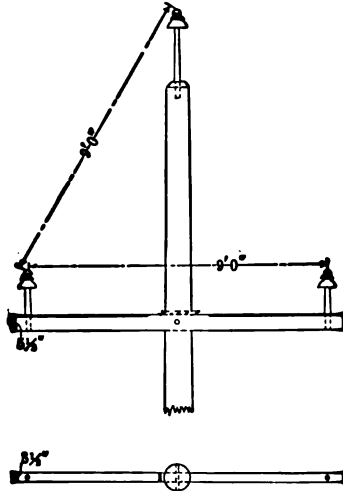

FIG. 4.—POLE TOP FOR TRANSMISSION LINE, MADISON RIVER TRANSMISSION.

the special form of steel pin employed to support the insulators. This pin is illustrated in Fig. 2 and is worthy of notice. It was

designed by Mr. D. L. Huntington, general manager of the company.

Another interesting illustration from current practice is shown in Fig. 3, which is the pole top made use of by the Shawinigan Water and Power Company for their Montreal transmission. The length of this line is about eighty-four miles, and it is now operating at 53,000 volts. The conductors are aluminum cable, each made up of seven strands of No. 7 wire. The insulators are of porcelain, made in three parts, and are supported on wooden pins. They were

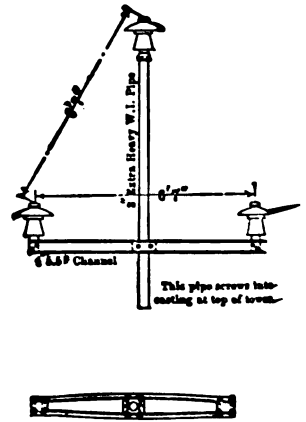
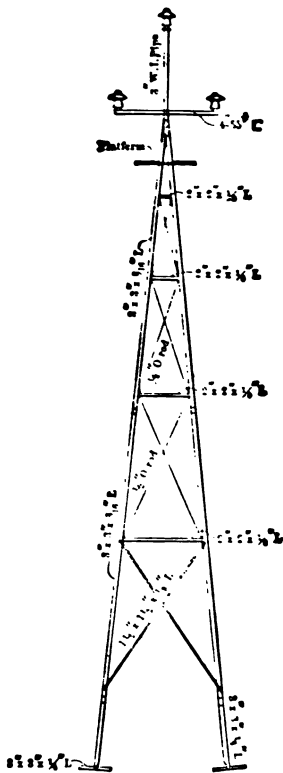

FIG. 5.—SPECIAL FOUR-POST LINE TOWER, GUANAJUATO POWER & ELECTRIC COMPANY.

FIG. 6.—POLE TOP FOR HIGH-TENSION TRANSMISSION LINE, GUANAJUATO POWER & ELECTRIC COMPANY.

especially designed for this installation by Mr. Ralph D. Mershon, the consulting engineer of the company.

A novel construction is shown in Fig. 4. This is the arrangement used by the Madison River Transmission operating into Butte, Mon-

THE NEW YORK  
PUBLIC LIBRARY  
ASTOR, LENOX  
TILDEN FOUNDATIONS



FIGS. 27 AND 28.—MISSOURI RIVER POWER COMPANY'S TRANSMISSION LINES.

tana. It is remarkable for the entire absence of metal, with the exception of the conductors. The cross-arm extends through the pole, and is held in place by wooden wedges and a wooden pin. This line is about seventy miles in length and operates at 40,000 volts. It employs glass insulators supported by wooden pins, and the conductors are of aluminum cable. It was built under the direction of Mr. P. N. Nunn.

A transmission which employs steel towers for supporting the conductors, has just been completed in Mexico by the Guanajuato Power and Electric Company. Fig. 5 shows a standard tower, and Fig. 6 the arrangement of cross-arms, pins and insulators. The towers are of a type used for supporting windmills, and are of very light construction, the various parts being fastened together by means of special bolted fittings. All the metal parts are galvanized. The towers are supported by anchors held in place by concrete foundations located at the four corners of the structure. A length of extra heavy 3-inch pipe, supporting the cross-arm and the top pin, extends above the tower. The pins are of cast iron, and the insulators of porcelain. The spans are said to average five hundred feet, while the sag of the conductors is about eighteen feet. The conductors are of hard-drawn copper cable. This transmission is intended ultimately to operate at 60,000 volts.

As a further illustration of current practice, the high tension lines of the Missouri River Power Company, built under the direction of the writer, are here briefly described.

This transmission has been in service for over three years, operating at 57,000 volts, delivering power at a distance of over sixty-five miles in a satisfactory manner. The country through which it passes is very rough as shown in Fig. 27.

The lines leave the generating station at an elevation of about 3,700 feet, pass over three distinct summits, including the Continental Divide, at which point they reach an elevation of 7,300 feet above sea level. There are two parallel lines extending from the generating station on the Missouri River to the Butte substation. They are located in the main on a private right of way 200 feet in width, from which all timber was removed. Each of the lines carries three copper cables arranged in a triangular position, seventy-eight inches apart. The cables are composed of seven strands and have an area of 106,000 circular mils. Fig. 7 illustrates the upper part of a standard pole. Fig. 8 is a section of the insulator, sleeve, pin and pole-top.

The poles are of Idaho cedar, the cross-arms of Oregon fir, the braces and pins of white oak, and the insulators and sleeves of glass. The cross-arms, braces and pins are held in place by means of through bolts. The pins in the top of the poles are of larger size and of greater length than those in the cross-arms, to provide for the greater strains there present. The pins were prepared by being first dried and then treated in paraffine, until all moisture was removed, and were then tested to 60,000 volts. The glass sleeves are not fastened to the insulators and merely rest on a shoulder of the pins, as shown in Fig. 8.

The circuits are transposed five times, making two complete turns between the generating station and the substation. The switching arrangements are such that the circuits may be operated

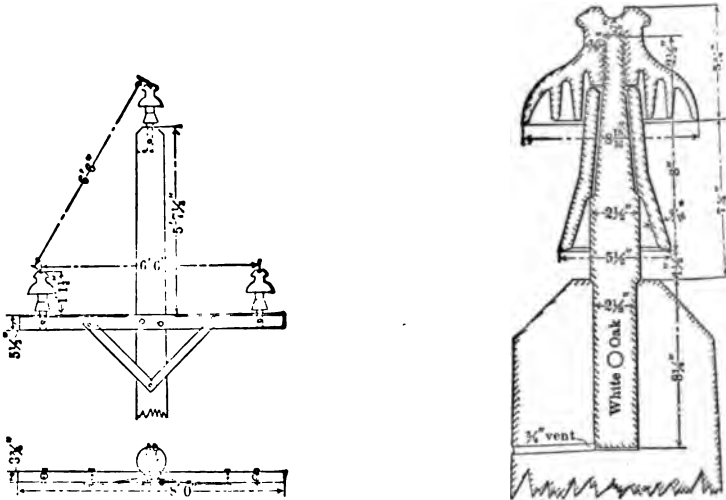

FIG. 7.—POLE TOP, HIGH-TENSION TRANSMISSION LINE, MISSOURI RIVER POWER COMPANY.

FIG. 8.—HIGH-TENSION INSULATOR, SLEEVE, PIN AND POLE TOP, MISSOURI RIVER POWER COMPANY.

either singly or in multiple. A telephone circuit is located on one of the lines and gives good results in service. The poles are from thirty-five to seventy-five feet in length, and the pole-tops are from nine to twelve inches in diameter. The poles are set from six to eight feet in the ground, according to height, and the standard spacing is one hundred and ten feet, with a maximum spacing of one hundred and fifty feet, when required by the nature of the ground. Fig. 28 shows the lines through timbered country.

The constructions just described were selected as typical examples of what has been accomplished in the building of high tension transmissions. Several of the lines mentioned have been in regular operation for periods varying from one to three years, and are in no sense experiments, but rather represent successful commercial undertakings. Other interesting and well-known systems might have been described had the limits of this paper permitted a further expansion of the subject.

#### LINE INSULATION.

The design of insulation for high pressure should involve a consideration of all the effects of electrical tension on the dielectric in the vicinity of the conductors. In the case of a line insulator, air is always a dielectric in combination with glass, porcelain, wood or other materials. Wherever there is a difference of electrical potential there exists in the surrounding media a certain state of strain called an electro-static field. This state of strain is the result of electrical stress applied to the insulating material. Dielectrics possess a sort of atomic elasticity, and electrical tensions produce a displacement in the molecular structure which, if carried beyond a certain limit, result in disruptive breakdown of the material. Before a difference of potential can exist current must flow into the dielectric, thus producing a state of strain equal to the electrical stress applied. If the material be not strained beyond its limits of molecular elasticity, current will flow from the material whenever the tension is removed or reduced, and a path provided. All dielectrics possess the quality of receiving strain before rupture, but not to the same degree. Solids and liquids generally possess it in a higher degree than gases. Whenever the limit of strain of a particular material is exceeded it fails structurally, resulting with a solid in a mechanical rupture, and with a gas in a change of molecular state which reduces its electrical resistance and renders it semi-conducting. It frequently happens when several dielectric materials are subjected to the same electro-static field, that one or more of the materials will be strained beyond the limit and will fail, although the others may withstand the electrical tension. Air adjacent to powerful dielectrics frequently fails in this manner, thus giving rise to the common brush discharge.

The structural failure of air, from an engineering standpoint, has been studied by a number of investigators, including Mr. C. P.

Steinmetz and Prof. Harris J. Ryan. It is well known that air at ordinary pressures and temperatures has a much lower dielectric strength than the common solid insulating materials. Air in thin films adjacent to solid bodies has greater strength than in bulk, but is still inferior to such substances as glass, porcelain, mica, treated paper, etc. The dielectric strength of air is affected by its physical condition, and varies directly as the pressure and inversely as the absolute temperature. Under uniform conditions all dielectrics rupture at definite applied tensions. Prof. Ryan has shown that there exists also for each dielectric material a certain strength of electro-static field which will cause rupture. When several materials in series form the dielectric, the one rupturing at the lowest value of electro-static field will fail first although individually it may possess superior qualities.

Line insulators are usually made of glass or porcelain, fashioned into a variety of shapes, all approximating certain elementary forms. Consider that alternating electrical tension be applied to a solid

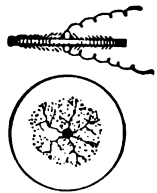

FIG. 9.—TENSION APPLIED TO DISC.

insulating disc, as shown in Fig. 9. If the pressure be low, only charging current will flow, but if the tension be increased sufficiently the air under and about the electrodes will be ruptured, producing brush discharge. This results in the formation around the electrodes of a zone of ionized air, of comparatively low resistance. This enveloping zone of conducting air has the effect of increasing the size of the electrodes, and thus the area to which the full tension is applied. If the tension be further increased, the zone of ionized air continues to spread over the surface of the disc, thereby increasing its capacity and the resulting charging current. Streamers will now form on the surface of the plate, and thus afford a path of still lower resistance whereby the current for charging the dielectric and ionizing the air is conducted to the outer portions of the ruptured zone. When the surfaces of the solid dielectric are parallel, as in this case, the streamers and ruptured air zone when once



started, would apparently continue to spread indefinitely, were it not for the cooling effect of the adjacent material, the appreciable resistance of the path through the ionized air, and the time element introduced by the alternating pressure.

Under the conditions as shown in Fig. 9, the streamers may unite over the edge of the plate, thus forming a short circuit, the distance travelled being several times as great as the breakdown distance through air for the same pressure. This result is not due to surface leakage, as frequently assumed, but is a phenomena of electrostatic capacity and local structural failure of the air as a dielectric. If instead of the pressure being applied to a small area, as

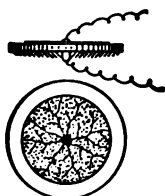

FIG. 10.—TENSION APPLIED TO DISC BY MEANS OF ENLARGED ELECTRODE.

in Fig. 9, the electrode be enlarged to a plate, as shown in Fig. 10, the same results will follow, but the spreading out of the ruptured air zone will take place on one side only and at a considerably lower tension. If pressure be applied to an insulating tube, by means of



FIG. 11.—TENSION APPLIED TO INSULATING TUBE.

a conductor inside and outside, as shown in Fig. 11, the air will fail at a certain tension, and the results will be similar to those obtained with the plate, in Fig. 10. The streamers will start from the conductor on the outside at *A*, and will run along the tube from the center toward the ends, the tendency being to cover the outer surface with an enveloping coating of ruptured air.

In this, as in all other cases, the streamers are drawn out in such a direction as to increase the electro-static capacity. If a still greater tension be applied, the streamers from *A* will finally draw sufficiently near to *B* to cause rupture of the air in bulk between *B*

and the ends of the streamers extending from *A*. If, under these conditions, the internal conductor be now removed from the tube, as shown in Fig. 12, the air about the point *A* will no longer be ruptured, and the streamers will cease, although the distance between *A* and *B*, and also the conditions for surface leakage remain as in Fig. 11. It will now require a material increase of tension

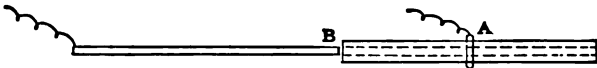

FIG. 12.—TENSION APPLIED TO INSULATING TUBE, INTERNAL CONDUCTOR WITHDRAWN.

to cause a breakdown between the electrodes, and this will occur essentially as if the tube were not present.

After initial rupture of the air, the spreading of the streamers

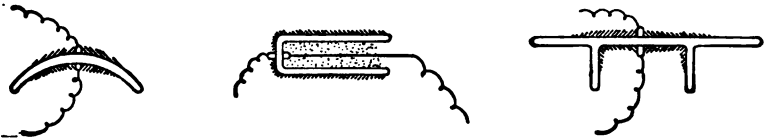

FIG. 13.—TENSION APPLIED TO INSULATING DISH.

FIG. 14.—TENSION APPLIED TO INSULATING RECEPTACLE.

FIG. 15.—TENSION APPLIED TO SPECIAL FORM OF INSULATOR.

is affected to a degree, by the form of the solid dielectric. Fig. 13 indicates tension as applied to a dish of uniform thickness, Fig. 14 to a deep receptacle, and Fig. 15 to a special form. The results obtained from the arrangement shown in Fig. 13 will not differ materially from those obtained from the arrangement shown in Fig. 9, or if one surface be made conducting, from those obtained from Fig. 10. In the case of Fig. 14, however, the air in the interior of the receptacle about the entering conductor becomes ionized at sufficient tension, and the conditions then existing are the same as if the receptacle were filled with a conducting substance. With the arrangement in Fig. 15 the streamers start as in Fig. 9, but upon reaching the downward projection they are forced along its surface and away from the streamers on the upper face of the plate, until a point is reached where the electro-static field is no longer sufficient to rupture the air, when the streamers die out and further spreading of the ruptured air zone ceases.

All line insulators are made from variations of the forms just

discussed. Surface insulation has little to do with their performance, and excepting the faces be made conducting by a coating of water or other foreign material, the surface leakage may be neglected altogether from an engineering standpoint. A wet surface, however, is practically equivalent to the metallic coating illustrated in Fig. 10. For high tensions wet surfaces should be considered as conductors, but dry surfaces need be treated only in relation to the electro-static phenomena already described.

A first consideration in connection with the design of a line insulator is its ability to maintain dry surfaces under all weather conditions. It has been frequently assumed that rain descends at an angle not exceeding  $45^\circ$  from the vertical, but this is not a safe basis for design. When rain is accompanied by wind at high velocity, and especially if the air currents be unsteady and in "gusts", and subject to deflection on account of the irregular contour of the country, it will then be found that at times the rain travels practically in a horizontal plane. As the rain-drops are often moving at high velocity, there will be also considerable splashing of the water where it meets obstructions, and this must be considered in predetermining the dry surfaces. With insulators of the "umbrella" type, there frequently results a wetting of a portion of the under side of the main petticoat, from water splashed from other parts. The shape of the insulator may also result in deflecting the air currents, thus carrying the rain to surfaces that otherwise would remain dry. Insulators of the "Italian" and "Double-Story" types are frequently affected in this way. Those of the vertical petticoat type are especially free from this defect, as the spaces between the petticoats are efficient in preventing eddying air currents from carrying moisture to the under side of the insulators.

After determining the extent of the possible wet surfaces, consideration should be given to the distribution of potential on the various parts of the insulator. The tension is applied between the point where the conductor is attached and some other point, depending upon the construction employed. During rains the entire upper surface of the insulator is at the potential of the conductor, and the ground potential is at the least directly under the insulator at the cross-arm. This condition holds with wooden construction as well as with metal. If a conducting pin be employed, the ground pressure will be carried still higher, and the tension will be applied across the comparatively thin material of the upper part of the insulator. The dielectric will then consist of the porcelain or

glass at this point, and the air adjacent to the conductor and pin. The tension will be that to ground, and for a three-phase circuit under normal conditions, will be less than the pressure between conductors, but as there are many operating conditions where full tension may be applied to the insulators, it is better practice, for the purpose of design, to assume that this is the case at all times. The form of the pressure curve also has an effect, as it is the maximum tension at the peak of the curve that causes initial failure of the dielectric.

If the tension as applied sets up through the material an electrostatic field sufficiently powerful, the air in series with the solid insulating material will be ruptured, and brush discharge and streamers will form, which unless checked, may extend over the entire insulating surface, causing short circuit. The spreading of the conducting zone of air may be prevented as previously explained, by the use of very large surfaces, or by employing deflecting projections, or petticoats, so arranged as to reduce locally the strength of the electro-static field to a point at which the air will not be ionized. These methods, however, serve only to stop the spreading of the ruptured air zone, and require considerable dimensions for even low factors of safety. All brush discharges are wasteful of energy, and are destructive of organic materials. It is brush discharge combined with capacity charging current that has caused the burning of pins on high tension lines. Common wooden pins are practically conductors for high tensions, and the ground pressure is carried up within the insulator. When the pins possess dielectric qualities comparable with the material of the insulators, the tension may be said to be applied between the top and base of the insulator, resulting in a greatly increased thickness of the dielectric material. This usually overcomes brush discharge and materially increases the reliability of the insulator. For the best results insulators for high tensions should be so designed that under no operating conditions would the electro-static field of force ever be sufficient to rupture the air adjacent to the insulating surfaces. This can be accomplished by properly proportioning the thickness of the material exposed to the electric stress.

The general dimensions of the insulator should, of course, be such that the direct air path from the conductor to the cross-arm will be sufficient to avoid failure through the rupture of the air in bulk. This is a matter of simple determination, involving only the length of the air path and the dielectric strength of the air in bulk at the

extremes of pressure and temperature, as found in service. When insulators are made of several parts cemented together, the dielectric material is no longer homogeneous, and the distribution of the electro-static strain may be materially altered. The cements commonly used, such as sulphur, litharge and glycerine, Portland cement, etc., possess entirely different and inferior electro-static qualities to the glass or porcelain of which the insulators are made. The cement between the sections is in series with the dielectric material of the insulator, and is exposed to the same electro-static field of force. The strata of cement in some cases redistributes the electro-static charge. Under other conditions, the pressure is conducted directly to the cement through the ruptured air. In this case the semi-conducting cement becomes charged with practically the full terminal pressure, and excessive tension may thus be applied to a section of the insulator not designed to withstand it. This frequently results in sectional breakdowns, and the insulator fails in detail. The irregular distribution of surface potential also affects the outside air path, and in some types of insulators reduces the tension required to rupture the air between the points of applied tension. When insulators are made up of several parts, the cement employed should possess dielectric qualities comparable with that of the component parts, and every effort should be made to render the dielectric material homogeneous so that there may be a uniform fall of potential between the points at which the tension is applied.

The resistance to disruptive breakdown or puncture of the solid dielectric is also of importance. Good porcelain or glass has, however, such great strength in resisting puncture that if the insulator be designed so as to entirely avoid rupture of the air near the points of applied tension, it will be impossible to puncture the insulator under operating conditions. One-piece insulators of glass or porcelain seldom fail from puncture, even if thin at the top, but two or three-part insulators sometimes fail by puncturing one or more of the sections, probably due to unequal distribution of potential, as previously discussed.

Of the various substances available, glass and porcelain have been used almost exclusively for high-tension insulators. Glass has excellent dielectric qualities, and can readily be obtained in desirable shapes, at reasonable cost. Its greatest defect is its mechanical weakness, which is due almost entirely to internal strains developed during manufacture. Consistent design of the surfaces so as to obviate as far as possible shrinkage strains, and careful annealing

have improved the conditions of many glass insulators so as to render them reliable for service, but they still do not possess the mechanical strength of the best porcelain. Glass, however, is a more reliable dielectric material, and from an electrical standpoint gives better and more uniform results. The best porcelain has great mechanical strength and good dielectric qualities. It is, however, difficult of manufacture in considerable thickness, and is very apt to develop flaws and surface cracks. Common grades of porcelain are unreliable and should not be used for high tension work.

While the insulator has been considered chiefly as an electrical device, it is still essential that it be treated as a mechanical support for the conductors, which function it chiefly serves. Practically all the mechanical strains on the insulators and pins are transmitted from the conductor. When the line is level and without angles, and when the spans are equal, the strains are due only to the wind and weight of the conductor. When angles in the line occur, a transverse strain is developed. If the line be not level or the spans not equal, strains having vertical and horizontal components are produced. All the necessary calculations for the forces acting and the resulting strains can be readily made by the ordinary rules of mechanics, and do not here require consideration.

The following described high-tension insulators were selected as representing American practice:

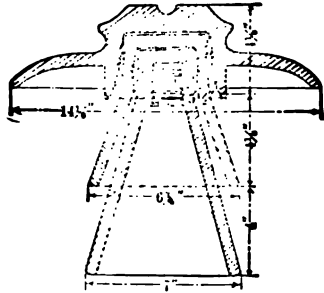

FIG. 16.—SECTION OF HIGH-TENSION INSULATOR.

Fig. 16 shows a brown glazed porcelain insulator, of the "umbrella" type. It is made in three parts cemented together, and weighs about 20 lbs. This insulator is in use by the Washington Water Power Company already referred to in this paper.

THE NEW YORK  
PUBLIC LIBRARY  
ASTOR LENOX  
TILDEN FOUNDATIONS



FIG. 21.



FIG. 22.



FIG. 24.



FIG. 23.



FIG. 25.



FIG. 26.

FIGS. 21 TO 26.—HIGH TENSION INSULATORS.



Fig. 17 is a section of a glass insulator also of the "umbrella" type. It is made of two parts cemented together, and weighs 13 lbs.

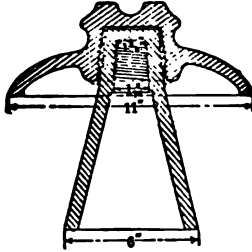

FIG. 17.—SECTION OF HIGH-TENSION INSULATOR.

Fig. 18 shows the insulator in use by the Shawinigan Water and Power Company, now operating at 53,000 volts. It is of white

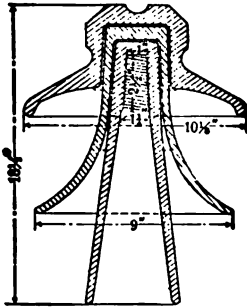

FIG. 18.—SECTION OF HIGH-TENSION INSULATOR.

glazed porcelain, in three parts. Its dimensions are given in the section. This insulator also weighs 13 lbs.



FIG. 19.—SECTION OF HIGH-TENSION INSULATOR.

Fig. 19 is a single-piece insulator of the "Italian" type. It is made of fine porcelain, brown glazed, and weighs  $7\frac{3}{4}$  lbs.

Fig. 20 shows a porcelain insulator of late design. It is brown glazed and made in three parts. Its weight is 26 lbs.

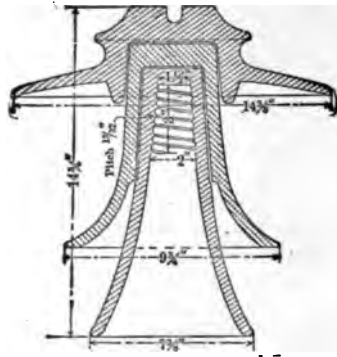

FIG. 20.—SECTION OF HIGH-TENSION INSULATOR.

The insulator shown in section in Fig. 8 is the standard insulator of the Missouri River Power Company and is in regular service at 57,000 volts. It is of glass made in two parts, and its weight is  $12\frac{1}{2}$  lbs.

Figs. 21 to 26 inclusive are reproductions from photographs of the insulators shown by the section drawings above referred to.

The developments in the construction and insulation of high tension lines have now reached a point where no doubt exists regarding the practicability of transmitting energy at tensions approximating 60,000 volts. From this time on it will be rather a question of expediency and engineering detail to determine the best methods of obtaining the desired commercial results. For pressures above 60,000 volts the field as yet is unexplored, but those who have followed this subject carefully agree that much higher tensions will ultimately be employed. The practices discussed in this paper, both for the general construction and for the insulation of high tensions, cover what has already been accomplished, but seem also to point the direction of future development in this branch of engineering.

#### DISCUSSION.

Mr. GERRY: In opening the discussion on Mr. Converse's paper, I wish to call attention to one or two points in connection with insulator design which I believe have been overlooked. This has resulted, among other things, in the discussion of the relative merits of iron and wooden pins. There is little ground for discussion on this point; both iron and wooden

pins have their respective values in particular cases. When properly applied, either will answer the purpose. Furthermore, because of these certain points having been overlooked, the great differences have arisen in high-tension insulator designs. I have recently examined an insulator weighing 50 pounds, having petticoats 36 inches in diameter, but it did not possess proportionate strength for withstanding the ordinary conditions of line operation. Mr. Converse has stated that surface leakage has an important bearing on insulator design. My experience has been that leakage, as it is ordinarily understood, plays little or no part from an engineering standpoint. Unless the surfaces be covered with water, salt, or some conductive powder, there is no appreciable leakage of current. However, a somewhat similar effect on the surfaces may be produced by a film of ruptured or semi-conducting air, resulting from the application of too great electro-static strain. The electrical tension is applied to the opposite sides of the solid dielectric, but in an insulator the dielectric includes, in addition to the glass or porcelain, the air immediately surrounding the electrodes. Under these conditions, when pressure up to a certain point is applied, very little current flows into the dielectric — only the small amount required to charge the material immediately adjacent to the conductors. If the tension be now increased, a point is finally reached at which the air near the electrodes is ruptured. This results in what is commonly known as brush discharge. The air becomes semi-conductive, and the electrode in effect expands, causing the charging current also to increase. This seeming expansion of the electrode, when once started, would go on indefinitely were it not for certain conditions tending slightly to retard it; such as the cooling effect, shape, and nature of the surface of the solid dielectric, and the time limit introduced by the current wave.

What actually happens, after the air is ruptured, is that the brush discharge finally extends over a certain limited area on both sides of the insulator. A comparatively slight increase in the potential applied will now greatly increase this area. In nearly all insulators recently designed, the solid dielectric is thin at the top where the tension is ordinarily applied. It follows that the air at this point is easily ruptured, and the brush discharge spreads from the electrodes over the surface of the insulator. Once started, it requires only a moderate increase in the tension to cause this brush discharge and its accompanying zone of ruptured air, to extend such a distance that an arc starts and a breakdown of the insulator results. Metal pins or wires inside the insulator, cause the tension to be applied directly across the thinnest part of the insulator, while insulating pins if of proper quality, form a part of the main dielectric, resulting in the tension being applied at more widely separated points. With most insulators in common use, conducting or semi-conducting pins have been employed, and this accounts for the very narrow margin of safety mentioned by Mr. Converse in his paper. This factor of safety may be increased, however, by consistent designing of the insulator, or by the use of an insulating pin. It is thus possible to increase many times the thickness of the solid dielectric to which tension is applied,

thereby enormously increasing the factor of safety under given conditions. If an insulator such as shown by Mr. Converse in Fig. 8 be supported on an insulating pin, it will be impossible to break it down, except through the main air path, and brush discharge will not start until the air in bulk is about to fail between the points at which the tension is applied — the tie wire and the cross-arm. This result is due to the fact that the solid dielectric is then of sufficient thickness to prevent the formation of a sufficiently strong electrostatic field to rupture the air prior to the point of rupture being reached through the direct air path. This is one of the points to which I wish to call attention, and it is of the greatest importance in connection with insulator design. If high potentials are to be applied to very strong and comparatively thin dielectrics, the air is bound to rupture, and it will be necessary to resort to extreme sizes of petticoats to prevent the spreading of the brush discharge thus formed. If, on the other hand, a more logical design be followed, and the insulator so proportioned, that brush discharge will not result, then the insulator may be strained practically to the point of failure of the air between the points where the tension is applied.

Chairman SCOTT: If we consider both high-tension commercial service and time, I believe we must accord to Mr. Gerry the honor of having operated at the highest voltage over the longest time. He has been operating nominally at 50,000 volts but actually at 55,000 volts, in continuous commercial service for two years and a half. His line is about sixty-five miles from the power house of the Missouri Power Company, near Helena, to Butte, Montana. Other plants have operated at a little higher voltage, others have operated at longer distances, but taking all together — high voltage, length of time, continuity of service, amount of power — his plant may be taken as one of the foremost if not the foremost example of high-tension transmission at this time. I believe he told me that he had not lost an insulator through break-down on the line due to electrical causes.

Mr. CONVERSE: Mr. Gerry prefaced his remarks by the statement that his ideas of the essential features in the design of an insulator were somewhat at variance with those expressed in my paper. On the contrary, I think we closely agree as to one of the most serious defects in the design of high-tension insulators, which is the lack of a sufficient thickness of material around the head. Mr. Gerry mentions the brush discharges which occur around an insulator, and I believe made certain experiments with dielectrics of different shapes in order to show the character of the brush discharges. He then applies the experiments in the design of an insulator and, I infer, finds the proportions of the insulator. Mr. Gerry's analysis discloses nothing new, and its results are rather doubtful. It would seem to be desirable to devise some way of measuring the potential differences between the various parts, in order to determine the rational design. I am inclined to agree with Mr. Gerry that wooden pins have been burned by the brush discharges and not by surface leakage of current. As to whether an iron pin will become a detriment in a very high-voltage insulator, I am in doubt; but incline

to the belief that it may be found to be the means of securing the proper distribution of potential.

Dr. F. A. C. PERRINE: In these two papers, two essential elements in insulator design are stated, namely, that the potential gradient from wire to ground, whether the ground be pin or whatever it be, shall be as gradual as possible, and that all surfaces exposed shall allow as complete a distribution of potential as is possible. These two principles, I think, are the absolutely essential elements of insulator design, and it is fortunate that in the midst of a lot of floundering, the men who have been actually building high-potential insulators have at last arrived at a correct scientific theory of the design of an insulator. Mr. Gerry has, fortunately for me, expressed very clearly the first principle. If we have two surfaces charged, then the tendency to break down the air is proportioned to what we may call the potential gradient from one surface to the other. As we narrow their distance, the potential gradient becomes steeper and there is more tendency to discharge around their edges. The other point is simply the question of discharge between surfaces. We all know that if we have two points presented to each other, there is a greater tendency to discharge than if we have two planes. We have at the petticoat edge of every insulator what is essentially a line of discharge. Now, to reduce the tendency to discharge from a line to any surface, we have to present to that line a semi-cylindrical surface. If we have in equivalent position a plane surface, there is more tendency to discharge to the nearest line in the plane than if an equipotential semi-cylindrical surface was presented at a distance equal to the minimum distance of the plane. In consequence, in all insulator designs, we will have the least tendency to discharge from the circular line formed by the bottom of a petticoat which is a conducting line, as Mr. Gerry has explained, in every rain storm, if the next surface to which it can discharge is an equipotential surface. That insulator is the best which has the lowest gradient of potential from the wire to ground and which has from its conducting points relatively dry surfaces in the next step to earth, which are described as circles around those conducting points. It is very nice to say that this is all theory which we have known for years. That may be true. At the same time we have not been applying it for years, and we have not understood its application to insulator design, and it is only through the work of such men as Mr. Gerry and Mr. Converse that we have been brought back to what Maxwell actually taught us about insulators. The most successful insulator design that I know has been carried out on these lines, and that insulator is one which has obtained a higher value of its breaking-down strength than any other that I have known tested, for its weight and inches. This insulator, which I think weighs about twenty pounds and is fourteen inches in diameter at the top, has its end of petticoats curved on the radius drawn from the line of discharge, the beginning of the circle being the horizontal distance where we may be sure that it is dry. This form of insulator is perfectly quiet in operation at 120,000 volts, in ordinary weather. In a severe shower from a hose it discharges over at about 107,000 volts. This particular insulator (referring to another design in Mr. Converse's paper) is an insulator which weighs over forty pounds, has

three inner petticoats, and discharges over at about 2000 volts less than the insulator (last described), although there is less than half the material in the latter. The arcing distance of any insulator can generally be calculated correctly by the nearest distance between these points which are wet and the next neighboring petticoat; simply add those distances together and look at your table of sparking distances, and you will generally find very closely the potentials at which the insulator would discharge under severe water conditions.

Dr. LOUIS BELL: One thing which should be brought vigorously to attention in these questions of insulator design is the possibility of getting practicable porcelain or glass for the work. By some strange fatuousness in the last few years each insulator designer has striven to outdo the others in size. Now, where you are attempting to stop leakage, it does not seem to be very advantageous to increase largely the surface over which leakage is possible. One would say that the less area and the greater linear distance along the line of potential gradient that can be obtained, the better off you would be. The consequence is we have had insulators rising from five, six, seven, ten inches in diameter up to that bath-tub of which Mr. Gerry spoke, which could be guaranteed off-hand to fail simply on account of the impossibility of getting porcelain of that size that is worth the power to blow it up. You cannot take a mass of cheap porcelain that you are trying to produce at the minimum figure, and get any valuable insulating qualities. By correct design not only is it possible to get longer distances so far as the striking is concerned, but it is possible to reduce the size and weight of the whole thing so that at least there is a possible chance of getting good porcelain. That, I think, is the line along which future design has to advance — to design scientifically, get all out of your material you can in the way of distances. The dielectric strength will generally take care of itself. I have seen so many bad porcelain turned out for these insulators, porcelains that you really wouldn't want in a baking dish, the cheapest kind of porcelain, shabby, with holes in the glaze and with the biscuit of the porcelain porous enough to take up water like a sponge. Those bad porcelains come with an attempt to make these enormous structures which really have not as great efficiency as the smaller structures. And as regards the question of wooden and iron pins, as Dr. Perrine has stated, it comes right down to a question of potential gradient. If you think the insulator will sustain the potential gradient, very well. Design your insulator so that it will sustain it and you will have no trouble with iron pins. I think there is no question in the mind of anybody who considers an insulator from the standpoint of potential gradient, that if you had a porcelain pole you need not worry about your insulators very much. Well, wood is a great deal worse than the porcelain, but at the same time a well treated pin, such as Mr. Gerry has referred to, is a great deal better as an insulator than soft steel. And if you are on the ragged edge of practicability with your insulator, you want all the insulating strength near it that you can possibly get. The question between wood and steel seems to be the question of fact as to whether we can get, under practical conditions, an insulator that will give

an adequate factor of safety while still carrying the earth's potential right up into its interior. It is not a question of theory at all; it is simply a question of fact. If you can get an adequate factor of safety in that way, all very well.

Mr. E. KILBURN SCOTT: I would like to ask the author whether he has any experience as between the relative values of brown and white porcelain? We find in England that the brown is not such an attractive mark for the small boys' catapult; but there is a feeling that the brown is not so good an insulator. Of course, the main thing in high-tension insulators is to get a vitrified material, which, when it is broken, shows a bright surface right through and which is not spongy or absorbent. What method is adopted for fastening or cementing the iron pins to the porcelain? If the iron is simply screwed into a thread, the porcelain is liable to crack off. I believe it has been suggested that a worm of lead should be placed between the threads of the iron and the porcelain. If such has been tried, I would like to know whether it has been successful. If I might criticise the author's design of a composite insulator, I think that a side-stress would cause the edge of the porcelain to chip badly where they come together. At the same time I consider it is a good thing to cover up the pin with porcelain. This was done with the Ganz insulators on the Valtellina Railway; but the pins in this case were of iron. With wooden pins, it might prevent sparking to the wood. I understand that these sparks gradually make tiny pin-holes, and it is only a question of time when sufficient pin-holes will cause the pin to collapse.

Mr. CONVERSE: The last speaker evidently has not understood that the purpose of the insulator shown in Fig. 12 was for an experiment, and not introduced as a commercial type. The results with the insulator, however, are along the same lines as Dr. Perrine has shown, except that I think Dr. Perrine furnishes a possible improvement in the shape of the outwardly extending petticoats.

Mr. R. S. HUTTON: Fig. 11 is about the form of insulator that we are using on the coast. The paper shows one that has a little trough around the edge with a drip-point on it. Those are the ones we formerly used, and what we call the eleven-inch insulator. Some of the types shown have given us trouble down near the ocean in the salt-air district, as we call it. Those insulators have all been tested on the rack and stand the test; but after they are put on the line, we find that after a time the wooden pins burn off. After taking one of these apparently defective insulators from the line, thoroughly cleaning it off, and putting it back on the test rack, it stands the test of 120,000 volts perfectly. The separate parts of the first ones used, were put together with sulphur, and we had some field fires that we were not able to account for. We afterwards found out that it was due to the fact that the leakage heated the insulator to such an extent that the sulphur was set on fire, and as it dropped down, set the grass on fire around the poles. We have now adopted a metal pin, made of the ordinary gas pipe; we are using 1¼-inch pipe, which is drawn down at one end and slightly roughened, so that a lead sleeve with threads can be cast on. These we find have given very satisfactory results. We find this particularly true for the reason that

having such a tall insulator, when we used wooden pins, they did not have sufficient strength, particularly for corner work. The iron pins stand up perfectly straight, keep their position, providing the balance of pole-top is properly constructed. We have recently adopted a new corner

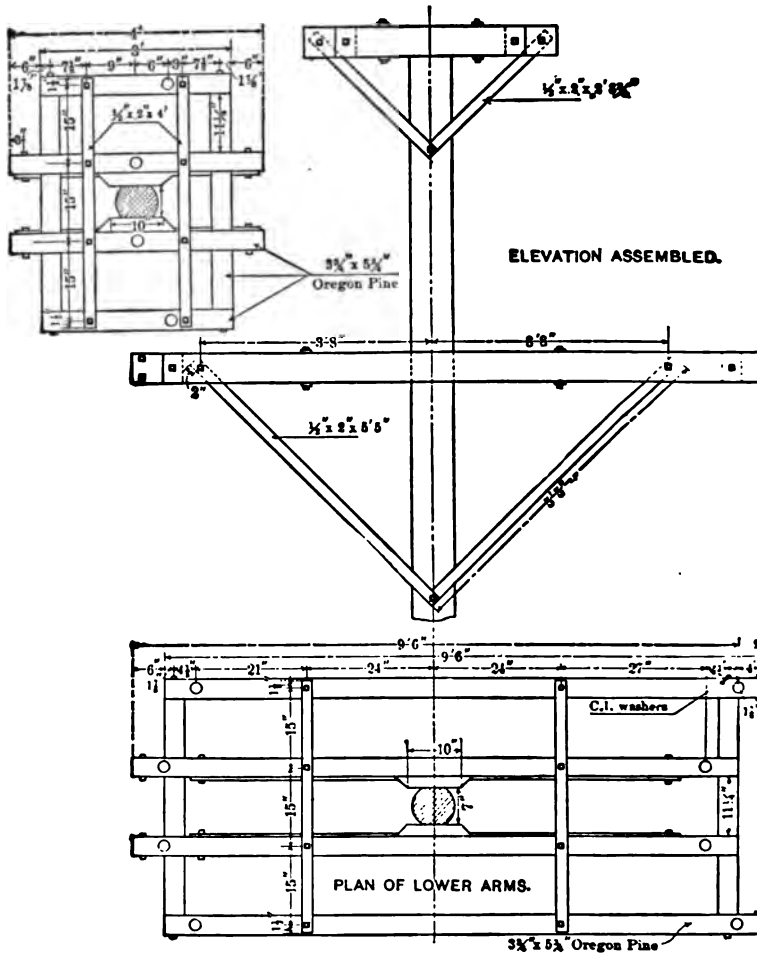

**pole-top.** (See accompanying illustration.) This is a form we use when we have a heavy angle, even as high as a 90-degree angle in a line. Instead of setting two poles for a corner, we now use but one, for we very often find, particularly in running through a city, that it makes the construction look rather unsightly, to put two poles on a corner; and in giving the proper distances, between the poles, it brings one of them around on the street directly in front, in such a way that it interferes with people's



property. We find that if we put one pole on a corner we can get along much more agreeably. It will be noticed by examining the illustration that these pin-holes are spaced in such a way that on a 90-degree angle there are  $22\frac{1}{2}$  degrees deflection on each insulator. With this arrangement, the corners stand up very prettily. The insulators have no tip to them at all. The cross-arms are made long enough in these cases so that the spread of the wires is exactly the same as it is in other parts of the line. I would like to ask Mr. Gerry if this type of insulator has even been tested with a metal pin or with a metallic sheeting around it, with metal in the top, or metal pin?

MR. GERRY: It was tested until the potential went clear around. When the potential was applied below it did not break through. This applies to an insulating pin, the dielectric qualities of which compare favorably with those of the glass. Such a pin may be of wood. Of course, wood is not an ideal material for an insulator because it is unreliable in some respects, but by proper treatment, especially with the vacuum process, it becomes an excellent dielectric. With such a pin supporting the insulator the results will be as I have stated.

MR. HURTON: That is on the assumption this pin is absolutely dry. It seems to me that where we have trouble with the fog, the under part of the insulator gets just as wet as any other part. Sometimes we have the land fogs without any wind whatever. This is due to the steaming of the land, from the fact we have the under-flowing water in the gravel beds and the coldness of the atmosphere above makes the ground steam and the fog simply rises and practically steams the insulators. The reason I asked Mr. Gerry about that particular test is because on this other insulator we usually test by raising the potential until the arc goes clear around the insulator, and if there be any weak points we find that the spark strikes at some point to shorten the distance, and I was wondering how that air gap would stand if you used a metal pin. What I want to get at is whether that particular form would be of any use with a metal pin. Mr. Converse spoke about the method of testing insulators, which was to use a salt-water solution. I would like to ask him if there are any reasons why, after an insulator is tested until the arc goes clear around, and is held there for a few seconds and there is no breakdown, that is not as good a test as putting it in salt water?

MR. CONVERSE: The salt water being a conductor, it serves to make connection all around the head of the insulator, and all around in the thread where the pin goes, thus giving a much better contact than could be obtained with metal. Also, in the case of a porcelain insulator, if there are any cracks or flaws, or if there is any tendency to absorb moisture, the salt water will percolate through and expose the defects.

Sig. F. CARINI: In answer to question of Mr. E. Kilburn Scott about the brown glaze insulators, there is a difference between brown glaze and white glaze insulators, namely, the brown-glaze insulators are usually made of common stoneware, and only have a very thin layer of glaze composed of silicate of soda, produced by the decomposition of salt, whilst the white porcelain has a very thick layer of silicate of alumina and lime. Concerning the wooden or iron pin, we have always used iron pins

in Italy, having never had any occasion to use, or to ask for, wooden pins, and are quite satisfied with our iron pins. As to attaching the iron and the porcelain, we have tried the lead cap; we cement a thin copper cap inside of the insulator, and this system has been lately patented throughout the world. I want to ask of Mr. Gerry, what is the coefficient of safety he would suggest for insulators? I mean, for instance, at what voltage should an insulator, meant to withstand 20,000 volts on the line, be tested?

MR. GERRY: That is always a matter of engineering judgment. The higher the better. At the present time insulators may be obtained having a factor of safety of from two to three, but as the art advances it will undoubtedly be desirable to use a much higher factor.

MR. T. J. CREGHEAD: In answer to Mr. Kilburn Scott in regard to the fastening of iron pins to insulators, I would say that I have had some little experience in that connection, from one point of view only — not in the operation, but in the design and manufacture of the pins. In that experience we have used two methods, one of which is very common and the other not so common. In the case of a malleable iron pin attached to the cross-arm by means of a steel stud, we have put a little enlargement on the head of the malleable iron, and fastened this malleable pin into the insulator by means of a lead compound, or by means of cement. In the other case, which is a little less frequent and one we look upon with a little more favor, there is a malleable iron pin, which has a specially designed wooden head. The particular size I have in mind runs about 8½ inches above the top of the cross-arm. The malleable casting is made about 9/16-inch in diameter and it has an enlargement on the head with a thread cut upon it. We screw upon that a wooden thumb in some cases treated with oil or paraffine. It is screwed down on the enlarged head, and that acts as a cushion for the portion of the glass insulator. As to mechanical tests, we find that this insulator will bear with about 1000 pounds of side stress, which we look upon as very satisfactory. A side stress of a thousand pounds per wire is as much as the ordinary pole-line, properly guyed, will stand.

Secretary BELL: The hour of adjournment is now slightly overdue, so that we will hold any further discussion that there may be on this paper Friday morning, at which time will be taken up the paper by Messrs Kelly and Bunker. Upon motion, the Section adjourned.

## SOME DIFFICULTIES IN HIGH-TENSION TRANSMISSION AND METHODS MITIGATING THEM.

---

BY J. F. KELLY AND A. C. BUNKER.

---

In discussing the conditions which affect and limit the constants and operation of high-tension lines, pressures of over 30,000 volts and lines of over 50 miles in length only will be considered.

The usual relations between voltage and length of line, namely, "1000 volts per mile," or "the pressure in thousands of volts equals one-third the number of miles," cannot be applied generally until all sources of interruptions are taken into account, so that the length of transmission does not altogether determine the voltage to be used, for a voltage as high as possible will be used and its value be determined from local and climatic conditions.

These will be the principal factors in the design of any line, as all the other constants, except, perhaps, the kind of conductor, are interdependent upon them. Since there is always some doubt as to the successful maximum operating voltage which these conditions will permit, and just how the line will be affected, it is well so to design the step-up and step-down apparatus that, without seriously affecting its capacity, several voltages, say 30, 40, 50, and 60 kilovolts, or even higher, can be obtained at will. This arrangement will permit the power to be transmitted with the highest possible voltage, and the causes which prevent the use of the next higher pressure can be studied and overcome if possible. As a new plant is usually started with a load less than its capacity, there will be no serious decrease in the efficiency by this method of experimenting.

The principal causes of interruption of the supply of power in the past and at the present time are: Open-circuit, grounds, short-circuits, and other circuit changes which produce oscillations.

There are many and various causes of weak insulation depending, however, upon, whether it exists in the ground, or in the air, or in a case where it might be called imperfect structure. All the causes may not be common to one locality, but all may exist in a large extent. It may be said that where the quality and design of the apparatus and accessories for the generating and sub-stations have been selected with regard to their requirements, and where such are afterwards intelligently handled, almost the entire list of troubles which are at the present time affecting the continuity of power service, may be credited to the line.

In designing a transmission line, experience has shown that the most careful study of local and climatic conditions should be made in order that all the facts and data bearing on these and their probable effects may be obtained.

It has been demonstrated that one transmission line for voltage over 20,000 will not give continuous service except when ideal climatic conditions exist. There is one, and possibly two, plants that have given continuous service for more than a year, with two circuits each, and with climatic conditions better than generally exist. It is believed that, in some localities, even with duplicate lines, the best insulators obtainable at present, and with perfect circuit-breakers, the maximum voltage which would permit continuous operation or delivery of power would be 40,000 volts, or possibly 50,000 volts with the utmost care and diligence.

The selection of the line-insulators depends entirely upon the voltage, mechanical strength required, and the localities through which the line passes, more particularly the latter, as lines have been operated at 45,000 volts with two or three types and sizes of insulators in as many different sections. The design of the insulators should be such as to give the smallest amount of still-air space and the greatest accessibility for wiping by hand. Fog occurring at the same time or intermittent with soil, factory, or car-dust is one of the surest causes of trouble, and reduces probably, to the greatest extent, the effective commercial size and value of insulators. Upon examining a large number of insulators which had to be removed, it was found that the dust, with which they were coated, was thickest in the still-air spaces, and was as thick on the vertical as on the horizontal surfaces. It has been found that where insulators were subjected to fogs or dust alone (except sea fog), the same number of troubles did not occur as when both appeared together. Where insulators are covered with dust parts

of each year, it has been necessary to shut down the circuit from one to three times during the dust season to wipe them clean. This can be done while in position and without disturbing them unless they are found to be damaged.

The fact that insulators are successfully tested for high voltage before they are put up does not necessarily prove that they will not cause any trouble when on the line. Insulators which were tested for 120,000 volts water test for one minute have given trouble in less than a month after being placed on a 40,000-volt line. Other types which had stood 40,000 volts water test for five minutes have been known to be unsatisfactory for 13,000-volt city (overhead) service, though this would not hold in every city. The greatest value of electrical test for insulators before being used is to determine whether the various parts are homogeneous and whether they have been properly cemented together.

If an insulator was made up of three separate pieces, each having been tested for say 80,000 volts before cementing, it does not follow that the completed insulator will stand 240,000 volts or even 120,000 volts. The striking distance of the completed insulator, together with the quality and manner of cementing, determines very largely the final test voltage, even though they have sufficient creeping surface for a higher voltage.

In cementing a large number of insulators together, it was noted that the percentage broken down under test could be reduced almost one-half by a little more care in the method of cementing. When insulators are glazed together at the factory, a uniform insulator should be obtained. The conditions for transmission are very good, if, for continuous use, 1 per cent of the insulators does not have to be replaced each year. Taking a circuit having 12,000 insulators installed, there would be at least 120 renewals each year. Each poor insulator is liable to cause a disturbance or interruption, and the system might be subjected to an average of 10 per month.

If some seasons of the year are more severe on insulators than others, there may be more than 30 cases of trouble per month. It has been observed that, where insulators were giving trouble on a line operating at 40,000 volts, reducing the pressure to 30,000 volts did not produce a like or immediate decrease in the number of insulators broken per month. The total number remaining seemed to be in a more or less weakened condition, and would

continue to break down after the line-pressure was reduced, though after a certain period of time, the breakage per month was less.

The difficulties of taking care of lightning discharges increase much more rapidly than the line-pressure, for the reason that any disturbance or change in circuit conditions, produced by getting rid of or dissipating a charge in a circuit having high voltage and high inductive and capacity reactances, may set up oscillations which, if not serious to apparatus, are disastrous to regulation and service. Various combinations and multiples of low-voltage types of arresters have been used, but where these have not had the proper addition of a resistance, they have seldom failed to be completely destroyed when the particular stroke or circuit change occurred. It has been clearly shown that the same arrester could not, without special adjustments, be used on all parts of the circuit, and that arresters performing their function for a lightning stroke, or taking the kick-back from a short-circuit opening, when a given number of generators, length of line, or transformers were in circuit, would not so operate for another number of generators, transformers, or length of line. This may have been due to the increased inductance in circuit obtained from a smaller number of generators or transformers, to a longer length of line, to the nature and duration of the arc in opening the short-circuit, or to any number together of these conditions. Where a resistance is used with any type of arrester, in order to keep the value of current which would flow over the arresters, to a given percentage of the load-current, the amount should be such that five or six times the normal impressed voltage can be taken care of.

A modified form of the Siemens' arrester has been used on circuits up to 50,000 volts with a fair degree of success when they were correctly adjusted for the different positions of the circuit, and, where a resistance was placed in series, the voltmeter cards were not painted badly when lightning or a short-circuit occurred. This design can be greatly improved, and no doubt would give very good results and thoroughly protect connected transformers. Their low cost, ease of construction, and their outdoor serviceability are points in their favor.

Perhaps the most reliable arrester is one consisting of an inductance and condensance in parallel, so that any frequency variation from the normal would cause a certain value of current to flow. This type, immersed in oil, would be rugged, and could easily be adjusted for any position of the circuit.

One of the best means of dissipating an induced charge or stored energy in a line is by having a distributed load along the circuit. If this load has a grounded neutral, the effect of a lightning stroke will be greatly reduced and more easily taken care of by the regular arresters. The star-connected line with grounded neutral has, however, some disadvantages of equal importance, which should be carefully considered before being adopted.

In practice, next to troubles from lightning, short-circuits on long lines of low ohmic and high inductive and condensive reactances produce the most serious consequences. It is, therefore, necessary to use accessory apparatus which will discharge the circuit between wires, as well as between circuit and ground. This point should not be lost sight of in the selection of arresters, and in their connection to the circuit. When a line is short-circuited from any cause, there is a rush of current, the value of which depends upon the impressed voltage and the impedance of the circuit up to the point of the short-circuit. When this current is suddenly interrupted, the voltage induced depends upon the constants of the circuit and increases in value with the length of circuit, distance between wires, the amount of inductance of the connected apparatus, the inductance of the rupturing arc and its duration, the impressed voltage, and the instantaneous value of the current when the short-circuit is opened. This induced voltage will be small or of little importance if the short-circuit is opened at or near the zero value of the current. In operation, induced voltages have been observed when opening a 40,000-volt 100-mile line when short-circuited, of from  $2\frac{1}{2}$  to 6 times the normal voltage, as measured by the length of air-gap broken down by the kick-back. In the more severe cases, some point of the system usually suffers; that is, there will be a discharge or arc across some point of the line or transformer terminals, a puncturing of transformer coils, break-down of insulators, the destruction of lightning-arresters, or some other like effect. In nearly every case the circuit is put out of service unless efficient arresters are used. The fact that there is not more damage done than would seem likely from the voltages observed is, no doubt, due to the property of solid dielectrics of withstanding momentarily very high voltages and which would be punctured in an interval of time. Air having the property of breaking down immediately upon the application of the proper voltage for the gap is the

probable reason why these manifestations more commonly occur in air, from terminals, and around other dielectrics.

The troubles from the charring of wooden pins were due to the continual leakage of current over dust-coated insulators. In some localities, pins would last only from one to three months. This was entirely corrected by placing a metal short-circuit around the pin. Molding at the thread, which is often noticed where the line passes through a marsh, can be prevented only by the use of a metal pin. Several lines have now been equipped with steel pins and no new troubles have developed, but, on the contrary, a decided decrease. It would seem that for large high-pressure lines steel pins should be used exclusively. Their initial cost is from one and a half times to twice the price of wooden pins, though cheaper in the end. Soft lead gives better results for the thread than any composition. The moulds should be made so that enough lead can be used to extend a little way below the bottom of the thread, as this will give a good bearing to the insulator over and above that obtained from the thread. This will greatly add to the mechanical strength of the insulator and of the line, as, with the ordinary pin, the insulator is the weakest element of the line. Precaution should be taken to have the thread portion short enough so as not to come in contact with the top of the insulator. This will prevent the tops being forced off when the insulators are put on the pins, and will allow a firm seat at the other end of the thread.

The service given by wooden pole-line construction is subjected to interruptions from falling and burning poles, due to decay, freshets, forest or grass fires, the large number of insulated points, and from the necessary short length of the poles. The decay of poles can be greatly lessened by continual inspection and care after they are up. The idea that poles of the right kind of wood for the soil can be placed in the ground and last for 10 or 20 years has been the cause of many and costly repairs. One 6-year-old redwood line, with butts treated before raising, had to have 33 per cent stubbs. Another redwood line, untreated, had to have 10 per cent stubbs in three years. Another line of untreated cedar poles required 35 per cent stubbs in six years. In long lines and even in some short ones, soils may be found that have an entirely different effect upon the life of the same wood.

Engineers are many times prevented from buying poles at the proper time to have them cut, on account of the interest charge



on the cost of the poles and erection, from the time the poles are paid for to the time when the wires are strung. The freight and hauling charges on from one-fourth to one-third more weight will offset a large amount of the interest charge. The result is that the poles are put in green and, unless they are afterward treated, decay will begin in a short time. If it is possible to obtain seasoned poles, their life will be much increased by thoroughly treating the butts before raising than by any subsequent single treatment. When green poles are used, no treatment should be given before raising, but the butts should be treated after the first dry season, and retreated every second or third season after, this depending upon the material used and condition in which the pole is found. There are on the market several kinds of treating material which are showing good results. This after-treatment consists in digging away the earth from the pole for about 18 ins. below ground-line and treating this surface, together with that 18 ins. above ground-line, after the decay and earth have been cleaned off. The old ground-line should then be changed by banking earth up around the pole. The cost of this treatment varies from \$0.60 to \$1.00 per pole, depending upon the location of the poles and the kind of material used.

At the same time the butts are treated, the pole-tops, gain cracks, and ends of the arms under the dead circuit should be painted. This is the best-known method whereby wooden construction, as a general thing, can be made to last the so-stated 20 or 25 years.

The burning of the poles at the ground has been the cause of interruptions even where the line was patrolled twice a day, but the remedy is simply a question of persistence and expense in keeping the right of way cleared of all growth. It might be noted here that, even with a generous right of way kept cleared, the wind may carry the heat from a fire toward the line. Two cases are on record where the heat from a forest fire along a pole-line was not great enough to harm in any way the wood arms or poles, but did cause large numbers of glass insulators to crack and fall to the ground. Porcelain is less affected by heat than glass, and probably would not have caused as much breakage.

Some of the unexpected sources of trouble show how detailed must be the design and care of a line, and what insignificant and harmless-looking objects and occurrences may cause the complete shut-down of a circuit. After everything imaginable has been con-

sidered and provided for, there may still be accidents. One case is known where some dried hay was carried up into a 40,000-volt line, with the result that it was set on fire and produced an arc that shut off the power. The burning hay, being carried on by the wind, did considerable damage. On another line, a flock of pelicans flew into the telephone circuit which was strung several feet below the power wires. The span was something over 600 ft., with a sag of 19 ft. The telephone wires were struck so hard as to wrap them around the power-circuit.

Another case was where a long piece of light bark was blown several rods across a 42-in. line, with the usual result. On the same line, during one season, there were three interruptions, in one locality, caused by large birds getting across two of the wires.

The falling out of step of synchronous apparatus, while not frequent, does happen and, unless the breakers operate promptly, other apparatus may add to the trouble and the circuit be opened. On the other hand, with proper attention to field strengths, synchronous motors have several times been known to keep in step during temporary short-circuits on their connected direct-current generators, the direct-current breakers being purposely set at a high current or tied in.

The question as to whether wooden poles or steel towers should be used for a given transmission will be determined by the advantages of one over the other for the conditions to be met.

In countries where wooden poles are plentiful and inexpensive, it is probable that every expedient will be resorted to before steel towers are used.

One of the principal advantages of wooden construction is, that, in case an insulator is broken, allowing the wire to come against the arm or pole, the burning which takes place almost immediately in most cases may continue for several minutes before a blaze is started which will short the circuit. Several times it has been observed that from 20 to 30 minutes elapsed from the time trouble was first noted by the ammeters or telephone until it was necessary to shut off the circuit. In one case a 40,000-volt (grounded neutral) wire lay on a dry cross-arm for several hours before the circuit could be shut off, and at the end of the time the arm was not badly charred. With a duplicate line, ample time would in most cases be given for changing from one circuit to the other, or to cut out the affected circuit, providing the telephone line was operative or the men at both ends recognized the difficulty.

For the past four years, engineers have tried to adopt, where possible, steel towers, instead of wooden poles, as a means of correcting a large number of line troubles.

At first thought, towers would seem to solve all difficulties previously experienced and certainly do eliminate a great many. The spans can be increased, so that as few as eight towers per mile can be used with safety. This would greatly reduce the number of insulators which can be larger, and the means for their attachment to the towers can be quite elaborate without exceeding the cost of the other construction. The height of towers can be greater, which will decrease troubles from wires, branches, and other material being thrown or blown across the circuit and reduce the breakage of insulators from the heat of forest or grass fires. If galvanized, or painted, occasionally, their life would be greater than could be expected of wooden construction.

Towers can be erected in places even more difficult of access, since they can be taken apart in pieces of lighter weight than a wooden pole. They would offer a more or less good lightning path to ground which would help to prevent the injury to connected apparatus, but will no doubt subject each insulator to greater strains. Any leakage around, or puncturing of, an insulator will mean the immediate shut-down of the circuit, and, in order to prevent the shut-down of the entire system, overload and reverse circuit-breakers of the best possible design will have to be used.

Auxiliary insulation of sufficient mechanical strength could be used to reinforce the insulators carrying the conductors, as the towers would be able to carry considerably more weight than wooden poles for the same cost per mile.

The most economical design of a tower is not suitable for a good many places where the line would have to be erected, and could only be universally used on a private right of way. On railroad rights of way, narrow county roads, village streets, etc., the spreading base would not be allowed, and resort would have to be made to steel poles, which for the same strain and height would be more expensive.

The distance between wires is usually determined from the highest voltage which can reasonably be expected as a limit, as determined above. The rule that the distance between wires in inches equals one and one-half times the number of thousands of volts is safe so far as the striking, or repeating, distance is concerned, though to correct for arcs holding on for a time after once

established would be impossible. Where the cost of erected poles is high, or the right of way expensive, two circuits per pole-line should be used, and, with good wooden construction, mechanical difficulties would limit the distance between wires to at most 60 ins., which would allow a line voltage of say 50,000 or 60,000. This distance between wires is for spans not over 150 ft. to 200 ft. The size of wire is determined from the load, voltage, length of line, losses allowable, etc. Five per cent energy loss per 50 miles with 60-cycle frequency gives a line which can be taken care of, but a smaller loss should be obtained where important lighting service is had in connection with a fluctuating load. On account of the distance and pressure, a charging current, at no load, is required of the plant, which at 60 cycles and one line 100 miles long, or 30 cycles and two lines, would require a generator as large as 2000 kilowatts, so that, unless more than this capacity had to be delivered as load, the system would not be economical. In order to be perfectly flexible, this amount of power would have to be carried over one circuit. The wire would, therefore, be large enough for mechanical reasons, and the energy loss per insulator, or per unit length, would be negligible, except, perhaps, for voltages over 60,000.

There is one plant in operation which, if the energy loss per insulator, or unit length, was as much as calculated from experiments, it would not be able to deliver load.

In stringing the conductors, especially if they are of aluminum, attention must be given to the temperature at the time the wires are tied in. This might seem to many to be a useless and tedious process; but a set of curves showing the sags for given spans and temperatures, in the hands of a careful line foreman, will give a line good in appearance, and at all times safe from overstrains. It is not so important to know what the maximum sag for maximum temperature will be, as the maximum strain at lowest temperature, with sleet, if any, taken into account. Aluminum cables are made which are as strong as copper for the same conductivity. When conductors are given the proper sag, a given safe tension, can be maintained for longer spans than would ordinarily be used in transmission work. There are a number of spans over 600 ft. in length, and have been in operation for two or three years. These have been closely watched during wind-storms, to see what deflection would be given to the wires. Three aluminum cables  $7/8$  in. diameter, 600 ft. span, 19 ft. sag, were deflected from 30

degs. to 45 degs. from the vertical by a wind that was estimated to be 70 miles per hour. All three conductors kept their relative position when deflected, and there were no perceptible waves or vibrations in the cables.

It is claimed by some who have had the opportunity to notice, that in longer spans there is less tremor, vibrations, or waves passing over the span when there is a wind than when there is none.

All observations of the writers show that, for spans of 600 ft. at least, there is no tendency of the wires to swing together in ordinary storms. Tornadoes would no doubt twist the wires together, but that would not be the worst damage done.

The height of poles or towers would depend upon the sag and whether or not a telephone circuit was strung underneath. With spans of 660 ft., the sag for aluminum would be about 20 ft., and with a telephone circuit 6 ft. below, a 65-ft. tower would give a clearance below the telephone wires of 29 ft.

A clearance of 35 ft. below the lowest power-wires is little enough for places where a house or derrick is liable to be taken under.

The frequency to be adopted depends upon whether the power is to be supplied to already installed apparatus of a given frequency. For long lines, a frequency of over 60 cycles will give a regulation difficult to allow for. The lower the frequency, the better will be the regulation of a line for a given load, the smaller will be the generator capacity required to charge the line, and the voltage drop will more nearly approach the  $IR$  of the circuit. For a given line, there is only one particular value of current where the condensance of the line will be neutralized by the inductance;

**NOTE.**—It is frequently stated by some engineers that a three-phase circuit should be strung with the base of the equilateral triangle on top in order to prevent more than one-phase being shorted by wires being thrown over the circuit and in order that synchronous motors will continue to operate until they can be thrown on to another circuit.

If a sketch is made of either a star or delta circuit, and a wire shown across two of the circuit wires, it will be seen that two of the phases instead of one will be shorted, and that what remains is a modified single-phase, with varying constants depending upon the resistance and the swing of the shorting wire.

It has been observed, under the conditions, that a synchronous motor will, if carrying load, immediately fall out of step. For mechanical reasons, it would be better to place the apex at the top in order to reduce the pull from the pole top, and for electrical reasons, it would be as well, since the men in charge of the line cannot be present to select the kind and length of wire that is to be thrown over the circuit.

so that this fact also decreases in importance. The swing of the power-factor at the power-house will not be so great and the point of maximum power-factor will be nearer full load. For a new system, or where possible, over 30 cycles should not be used.

With the general use of A. C. railway motors, 15 cycles or less may be advisable.

The power-wires of a single- or double-circuit line should be transposed with reference to the power-taps and talking-points.

Experiment has shown that transpositions at stated distances need not be made and may not give as good results as the first method. With two circuits, one should be transposed in the opposite direction to the other; although there is one double-circuit line operating satisfactorily as far as the telephone is concerned, with one of the circuits run straight through. Experiments made with a power-line without transpositions and a telephone transposed every fifth mile placed 5 ft. below the power-wires, gave a pressure to ground of from 2100 volts to 2800 volts when the line-pressure was 40,000 volts. With 30,000 volts, the telephone voltage to ground was reduced in the same ratio.

By giving the power-wires two-thirds of a rotation between power-taps and talking-points, this voltage was not readable on a Weston or hot-wire 150-volt voltmeter. The induced voltage was due to capacity, and in none of the tests was there any measurable electromagnetically-induced voltage.

The large number of fatal accidents, which have occurred in the past from the telephone circuit being placed on the same poles with and under the power-wires, would warrant a separate pole-line, even if the service were no better.

A telephone is most needed at times of line disturbances, and at such times it is rarely of service. The induced voltage on a telephone circuit, even where power-line transpositions are made, when one or more of the power-wires are out or grounded, is high enough to be dangerous to life and to set fire to adjacent woodwork. The distance between the two circuits should be at least 6 ft., and 8 ft. would be better. In stringing the telephone wires, the same sag should be given as to the power-wires. For lines over 50 miles in length, copper or aluminum should be used instead of the regulation No. 9 BB.

The question of high-tension switches and circuit-breakers is one of the most important in the operation of a system. They should be of the most approved design only, and placed at both

ends of a circuit and at intermediate, or cross-over, points. All poles of a three-phase switch, or breaker, should work together and not singly. A switch which tests satisfactorily in the shop may not operate in service; so that it should be placed in position and opened 10 or more times under the most severe conditions with which it is likely to meet, before it is pronounced safe. All breakers and switches should be provided with cut-out switches on each side, so that they can be taken out of a *live* circuit for repairs.

#### DISCUSSION.

Mr. BUNKER: There was a statement made yesterday in the discussion that there was no ground for argument on the advantages of iron over wooden pins. There are some localities where wooden pins have no doubt been entirely successful; but as a general case, I would like to take exception to that statement, because there are plants now operating where they have a great deal of trouble with pins, and some of the pins only last from one to six months, until they begin to burn or mould, while in some cases they burn entirely off within that time. There was also another statement made that the burning of pins was due to the brush discharge and charging current of the pin. I suppose the charging current was due to the electrostatic capacity of the insulator itself. It was not stated what the brush discharge was due to, but if there was a brush discharge around the insulator it was either due to the fact that the insulator was not large enough for the voltage under normal conditions, or else that the insulator was covered with some dust or dirt. Now, in a given line, the pins are subjected to the same static pressure at all times. Some of them lasted two years and over, and have not been changed yet, being apparently as good as they ever were, while in other localities the pins have been changed as many as three times in one season. These were wooden pins, and I might say were made with as great care as possible. The sap was boiled out of them, and they were then treated in oil at about 100 degrees Centigrade, so that the insulation of the pin, when new, was perfect. You could subject a pin along its length to 60,000 volts without any effect and could leave it there as long as desired. The pins were of eucalyptus wood.

Mr. E. KILBURN SCOTT: When you say "burning," what do you mean?

Mr. BUNKER: When you put an insulator on a line, using wooden pins, and everything is new and clean, there is no discharge or sound from it; but after it stands awhile, in certain sections you begin to hear a discharge, and if you watch the insulator at night, you will see, up in the thread portion underneath the inside petticoat, a discharge taking place. This gradually begins to burn the wood and after a while burns the pin entirely off at the bottom of the thread. Pin holes are at first made but after the char becomes general, it keeps getting deeper and deeper as a regular burn. There is only one remedy for moulding and that is a metal pin. I am not able to state what would take place where a line crosses a fresh-water marsh, but I do know in a salt-water marsh that a pin that



lasts six months is considered to be doing well. That rot or mould has a white appearance and is very soft. When you take the insulator off, you can very easily rub the threads off with your thumb. The treated pin appears to mould as rapidly as the untreated pin. The pins are treated with boiled linseed oil, after the sap is boiled out and drying, then being subjected to the hot oil, but not in a vacuum.

Dr. LOUIS BELL: In this suggestion of treating pins, I asked whether they were treated by vacuum treatment, and I regard that as of fundamental importance. You can boil even a thing so porous as a coil of wire, in insulating material,—for instance, melted paraffine—until you get black in the face and give up in despair, and then take it out and the insulation will not have thoroughly penetrated. Put that same coil of wire, in vacuo, in hot insulating material, and you see the gases rush out of the thing, and the whole surface of it foams for minutes. After that is over, the insulation has a chance to creep in. I therefore should ascribe some troubles to which Mr. Bunker refers, to the fact that although the pins were thoroughly treated, apparently, there was no small amount of material which the insulation did not fully penetrate, so that while it would hold the voltage for a while, the remaining air and moisture would sooner or later get in their work, the air helping the oxidation and the moisture gradually working itself through the structure. I should like to see the thing tried with pins which had been very carefully and thoroughly dried, to see whether the time effect would take place to the same degree.

Mr. BUNKER: On the other hand, you take a metal pin and put it in the same locality and you would not have any trouble at all.

Dr. BELL: Save perhaps in puncturing the insulators. I approve of metal pins from a mechanical standpoint, but when we are fighting the high voltage I think if we can get any insulation strength below the maximum insulator on which we depend, we are so much better off in the desperate fight against creeping due to atmospheric moisture and to dirt accumulating on the insulator. If we could have a porcelain pole, in other words, we wouldn't have very much trouble in protecting insulators. The more insulating material we get in series, the lower potential gradient we have, and the less trouble we are likely to have. So that if it prove to be possible, as I hope it may, to use some absolutely non-metallic material for the pins, we shall be vastly better off than if carrying our ground to within an inch or half or three-quarters of an inch of sixty or eighty thousand volts. When we do that, we pin all our faith on the insulators, and insulators, as we see from this paper, sometimes fail; they do so much oftener than we like to have them.

Mr. E. KILBURN SCOTT: How would you stop the moulding of the pin?

Dr. BELL: I do not believe, with a properly designed insulator, the moulding of the pin, which is due largely to the brush discharge, as far as we have been able to ascertain, is going to take place, and I think in an iron-pin line, particularly with iron towers, you are depending too much on the insulator. Anything that happens to that insulator means just one thing—a complete shut-down, because you have grounded the whole circuit. As very properly noted here, you can have some troubles on a



wooden pole line without causing that. And while eventually we may, and probably will, use both steel pins and steel towers very largely, that being a matter which has to be treated symptomatically, still I do not believe that an attempt to get an insulating pin should be abandoned at the present time, and I do not think that with proper treatment of the pins, and with a properly designed insulator — in other words, an insulator which will hold back, as far as possible, the brush discharge — the matter of burning the pin, which in some places has been very serious, is going to take place to anything like the same extent. At least it is to be hoped so.

Mr. BUNKER: There is one thing I would again like to bring up in that connection, and that is that when the insulator and when the pin are new, when they are both clean, there is no brush discharge that you can detect, either by sight or sound; the brush discharge only occurs later on, as the insulator becomes coated with either fog or dust. And it has been my experience with all high-pressure discharges of a static nature, where they were produced from transformers, that they immediately set fire to combustible material.

Dr. BELL: There is no doubt that treated wood has insulating properties of a fairly good quality. The question is whether they are permanent. With many transmission lines, they have been using pins under conditions which would lead one to expect trouble, and yet the trouble has not occurred. Of course, if the insulators are allowed to get dirty, you will get dynamic discharges anyhow, after a certain point, particularly if subjected to salt fog or anything of that kind. But it seems to me that throwing away the insulation of properly treated wood, is not a thing which should be done without due cause, and I do not think that the burning trouble has been sufficiently general as yet, to make one feel that it should be thrown away without any further attempt to improve the question of insulating the wooden pins. We have had wooden pins described on several lines — for instance, Mr. Gerry's — where they have been in absolutely successful use, as far as we can find out, and it strikes me that these brush discharges are due very largely to an imperfect design of insulator. Of course, where you have dust storms, as in the case of some of the plants west of us, which coat the insulator with mud, or with moisture which is more or less dusty, it is very hard to keep up the insulation in any way. But in the face of the fact that some of the very large high-voltage plants are using wooden pins successfully, it does seem to me that throwing up the game and depending on the insulation strength of insulators alone — which is great, of course, but still is subject to failure — is an unwise proceeding. I think we want to exhaust the possibilities of an insulating backing for our lines before we absolutely throw it aside. I hold no brief for wooden pins at all; am perfectly willing to use the steel ones when I can get them combined with insulators that will meet the requirements. But anything in the way of additional precaution seems to me justifiable.

Mr. N. J. NEALL: I should like to ask whether you have had any use of glass shields for pins?

Mr. BUNKER: No, I have never had any experience with glass shields.

The only shield we did have was a small sleeve at the base of the pin— This cracked off, having simply allowed the dust to collect around the pin— and prevented the rain cleaning it off.

DR. BELL: The glass shield was practically a pretty deep petticoat that Mr. Gerry used, but it simply protects from these brush discharges. Under the existing working circumstances of the line there is no trouble from that cause. The pin and insulator, whether steel or wood, must be treated as a single structure. The support of the line depends on the electrical and mechanical strength of both those elements, and that is generally the weakest point in a line, from both standpoints. But it seems to me that Mr. Gerry's immunity from trouble with pins is to be ascribed to his very successful and careful insulator design more than anything else.

MR. BUNKER: I think it due to climatic conditions more than anything.  
Secretary BELL: Possibly.

MR. NEALL: I think the insulator, mechanically, which Mr. Bunker has in line, would appear to you as being the same as Mr. Gerry's; because the latter has simply a sleeve on which the insulator rests, while the former has a long sleeve attached to the insulator and the space below this, where the pin could be exposed, has been covered with a small porcelain sleeve.

MR. BUNKER: They simply allowed the dust to get in, and there was no way to clean it out.

DR. BELL: The absolute difference in experience between Mr. Gerry and yourself must have some basis. Both insulating systems were unquestionably built with skill and care. The difference may be purely climatic. The fact remains, however, that Mr. Gerry, on a very high-tension line, has been using wooden pins with complete success, so far as we can find out from him.

MR. BUNKER: The result to be obtained is the smallest number of shutdowns possible. Now, in a fog section we have had as many as twenty-six shutdowns in a month from broken insulators and wooden pins. We have changed as many as 600 wooden pins in a month. When we got on the steel pin the number of line troubles was greatly reduced. The voltage is 40,000, but even at 30,000 volts, if you can get better service with a steel pin, that is what you want to use.

MR. N. A. ECKART: I would like to ask Dr. Bell if, with pins treated by the vacuum process, he would expect the trouble to arise from moisture still in the pin or due from outside conditions, from atmospheric conditions.

DR. BELL: I should expect the trouble would largely come at first from the fact the insulating material had not worked thoroughly into the pin; in other words, had left it only partially filled. Second, from the fact that the presence of moisture and air remaining would gradually tend to damage the insulating material which had worked in. In other words, I shouldn't think it anything remarkable if some of the moisture, under stress of heat and cold and diffusion in time actually got through; so as to damage the insulating properties which had been obtained initially. I have never had any chance to compare, on a large scale the vacuum-treated pin with one that is merely boiled, but I know, from considerable experience in forcing insulation into material in general, including wood,

that the vacuum process is the only way of getting all the moist air out of the pin.

**MR. BUNKER:** There is another thing I would like to mention in regard to that point, and that is the burning and moulding takes place inside of the insulator above the lowest contact of the insulator with the wood, so that you get very little oxidation action from the air. In fact the greatest moulding is at the top of the pin.

**DR. BELL:** Mainly on the thread where the fibers are cut crosswise?

**MR. BUNKER:** Yes, but it is away from the air.

**Secretary BELL:** Well, partially away from the air.

**MR. BUNKER:** But at that point, the threads, of course, are the most saturated with oil.

**Secretary BELL:** May-be.

**MR. BUNKER:** There is no question of that. We sawed several pins through to see.

**Chairman SCOTT:** A gentleman who in recent construction has concentrated himself along the wooden idea, both in poles, pins, cross-arms, braces and everything else, so that everything is wood and no metal at all, is Mr. Nunn. If he can add something to our discussion now we will let him have the opportunity for a final word on this question.

**Mr. P. N. NUNN:** The experiences of the Telluride Power Company seem to show that wooden pins are all right when rightly treated. The 40,000-volt Utah transmission was put into service in 1897, when 16,000 was the highest voltage elsewhere used. This was an advance at one step from 16,000 to 40,000 volts,—nearly thrice. That transmission has now been in operation for seven years, has been entirely successful, and is in operation to-day. The same pins and insulators used at the start are still in use—paraffined locust pins and Provo type glass insulators. These have since been used everywhere, and in no known case have pins been burned or replaced, except on account of broken insulators or the severest salt storms. The insulator has been criticised in all quarters, and its undeniable success has been attributed to the paraffined pin. Now that pin is said to be bad. The Provo insulator is certainly inferior to those now generally used for 40,000 volts. It was designed in the day of 16,000 volts maximum. These later and better insulators represent the advance of seven years in insulator development. The Provo insulator was known to be inadequate to use with metal pins; hence they were used with wooden pins impregnated with paraffine by the following method, previously devised and since used:

Clear, straight-grained locust pins are stirred for six to twelve hours in vats of hot paraffine at 150° C. and then kept submerged during slow cooling. If the pins are green, the boiling must begin at a low temperature, be slowly raised, and be continued much longer than if dry; but no matter how dry they may be, water vapor will be freely liberated for some hours, this part of the treatment being little more than a method of kiln drying. While slowly cooling, however, the condensation of water vapor remaining in the wood provides a most perfect "vacuum process" which sucks in the still liquid paraffine. If a sliver be removed from the center of a pin treated in this manner, it will be found well filled with paraffine

On one occasion during a severe storm following a long period of dry weather, partial grounds developed upon a section of line supplied with insulators from a certain shipment which had been improperly annealed. After the storm, over 50 broken insulators were removed, yet no interruption had occurred and few pins had been burned. According to the results of a laboratory test, published a few years ago by a prominent insulator manufacturer, the entire capacity of the Provo plant should not be sufficient to supply leakage current to half its lines in bad weather. Yet the facts are that leakage has never been appreciable. Wooden pins are said to burn with slightest leakage, yet brush discharge has rarely been visible, and then only when insulators and pins have been heavily coated by salt storms, and no difficulty has been met from burned pins. These salt storms are believed to be as severe as any sea-coast spray, and it does not seem probable that serious trouble would be met upon the coast with properly paraffined wooden pins.

MR. BUNKER: Just one thing I would like to mention in regard to the last remark, and that is that where we removed several wooden pins we put the same insulators back onto the steel ones without experiencing any trouble. My argument in regard to the iron over the wooden pins is simply as a general case. I agree with you and Mr. Gerry that in a great many localities wooden pins are all that could be desired, but in other localities something else will have to be done, either in the treatment of the pin or the use of steel.

MR. K. LANDTMANSON: I should like to ask if for all voltages wooden pins are used?

CHAIRMAN SCOTT: I think I am right in saying that both kinds of pins are used; that in general wooden pins in work that would be called transmission work; sometimes where the wires are heavy, iron pins are used. One difficulty with the pin on the higher voltage is that they need to be large and consequently the metal pin is especially desired on account of its strength, and in high-tension work the pole lines are out over the mountains and sometimes have longer spans, so that the difficulties of construction and inspection are greater than with the low-voltage lines which are not so long. I believe I am correct in saying that wooden pins are generally used for the lower voltage work where they can be used. That is the preference.

MR. LANDTMANSON: If you have a line of, say 50,000 volts and if an insulator broke down, have you found danger from touching a pole? I have heard that a man has been killed who touched the wire with a wet ladder, and I think if we have, say, 50,000 volts between two wires, and if an insulator breaks down and the wire then touches the wooden pins, that the leakage can be so great that a man who touches a pole can be killed by it.

MR. NUNN: No one has ever been seriously injured in that way. A few poles have been carbonized along a streak down one side throughout their length. Leakage can be determined by feeling the pole near its bottom.

MR. E. KILBURN SCOTT: Where you have great depth of insulator, I think pins made of malleable iron are good; because they can be made

with a good broad base to rest on the cross-arm. They might also have a vitrified surface. I have seen many articles of steel or other metal furnished with quite a thick coat of glaze or enamel and they could be dropped on the ground without breaking the glaze. I should think the glaze might be of value from the standpoint of insulation. Regarding wooden pins, I think I can safely say that there is no such thing in all Europe. We are quite satisfied with steel pins; but then, of course, we do not have your very high pressures. As I may not have an opportunity of referring to it again, I may mention that in some of the British colonies, there is great trouble with the white ant. If, in such places, a wooden pole were to be placed in the ground, all the inside wood would be eaten away; indeed they would think nothing of invading the cross-arms. The poles must, therefore, be of iron, or be composite; i. e., have an iron socket in the ground, and only the upper portion of wood, as at Cauvery Falls. To give an idea of what the white ant is capable, there is a story of an Anglo-Indian official who left his house in India for some considerable time. The white ants penetrated the legs of a table, and after they had cleaned them out and the table top, they crawled up and ate the inside of the family bible. When the official returned, everything seemed all right until he laid something on the bible, when it went right through.

**Mr. J. S. PECK:** One thing struck me as rather interesting as showing the difference of opinion of eminent engineers on the same subject. Mr. Baum told us a couple of days ago that when you exceed 60,000 volts lightning protection need not be considered. Mr. Bunker says the difficulties due to lightning discharges increase much more rapidly than the line pressure. I would like to ask Mr. Bunker whether he has ever tried the arrangement he speaks of in his paper—that is, an inductance and condenser in parallel with the lightning arrester and air gaps?

**Mr. BUNKER:** I should have stated that it has only been tried in laboratory experiments. That is Dr. Kelly's idea of an arrester, and it has never been put in practical operation. As regards lightning protection, when the voltage goes up, I think nearly everybody will agree that inasmuch as the impressed voltage is a function of your troubles, the trouble is going to increase. For instance, at 25,000 volts we would have very little trouble as compared with 40,000.

**Mr. R. S. HUTTON:** I think the proper construction of Mr. Baum's remarks is, that as lightning arresters had given considerable trouble at 40,000 volts, if you attempted to go higher it would be harder to make a successful lightning arrester. We know we have lightning arresters that are quite successful at ten, fifteen, twenty thousand volts. Some may have been made that are giving good service on even higher voltage; but it stands to reason that when 40,000 give trouble, and considerable trouble, that if you go to 60,000 you are going to have more. Now, Mr. Baum meant this: That with the particular conditions which we have on the Pacific Coast, severe lightning is very infrequent, and as it does not bother us a great deal, it is not necessary to have any elaborate system of lightning arresters. Therefore, the horn arrester has practically answered the purpose. As we increase the insulation on our whole system, which is necessary to be done, of course, with increasing voltages, I think we shall have less trouble from lightning, but at the same time it

would be more difficult to make a lightning arrester to take care of it if you did attempt it.

MR. PECK: I think the point you made last was the thing he had in mind — that the lightning effect is, in a sense, constant and that the factor of safety which you have in a high-tension plant is such that the lightning effect, added to the normal pressure, is not sufficient to break down the system. At least that is the argument I thought he advanced.

MR. HURTON: Mr. Baum stated the other day when his paper was being discussed, that no poles, to his knowledge, had ever been struck by lightning. Just before Mr. Baum was connected with the company, the Sacramento-Colgate line was struck about ten miles, I think it was, from our sub-station. The transformers were connected at the time at both ends on the high-tension side, but the low-tension sides were cut out and the line was not being used. Two poles were completely destroyed. The line is run along a county road which is fenced off with barbed wire, and it tore all the posts to pieces in the span between the two poles and pretty nearly consumed the barbed wire, but the line wires on the pole and the insulators were uninjured. The cross-arms were all split to pieces and lay in a tangled mass, about half up the pole. There was not the slightest kind of a burn on the line wire. Nobody knew anything about it until we tried to put current on the line. As the wires were together in contact, they did not get any chance to burn from an arc and when we sent a man out he found this mess.

MR. E. KILBURN SCOTT: Of course, the inside of the metal socket pole I referred to just now is filled with concrete. White ants never crawl outside of anything. Another difficulty which has to be considered in the East is the monkey difficulty. In some cases these animals will climb up the poles, and the only way to prevent them is to wind barbed wire around the poles. The ordinary spiked ring which deters a small boy or a native is of no use with a monkey. Perhaps some day we may be able to print danger notices in the Simian language.

MR. NEALL: Mr. Scott's remarks lead up to one conclusion that I think has been lost sight of, and it is this: If we could depend absolutely on the insulator, and use metal pole construction throughout, we should then know exactly the weak points of the line, and by making due allowance for the insulators and their effect on the line — such for example as their capacity effects at times of line disturbances — we could anticipate the troubles more closely and consequently have better service.

MR. NUNN: Without doubt metal pins will eventually be used with each successive transmission voltage, but they should be used only when that voltage and its insulator have passed their experimental stage. In pioneer work insulators are always likely to be worked to a very close margin, and then they should be supplemented with treated wooden pins.

CHAIRMAN SCOTT: In the remarks Mr. Nunn has just made he has struck the key-note of transmission work as it has been in the past, and while we are apt sometimes to consider that things are pretty well established, the same word I think will apply for many years to come — pioneer work. As we branch into new fields of high-voltage work, we encounter new experiences; new things, as well as matters which were of no

concern before, come up to the first rank in importance. Take our whole discussion this morning and what has it been? It has been on the insulator pin, a thing which a man not familiar with the subject would think one of least consequence, but we have found that it is one of the vital points; that the different methods of construction and treatment, and the experience which in one place and by one man differs in many ways from those of others. Now, one of the pioneers in this work, a man who has already said in his remarks a few minutes ago what I intended to say at this time, a man who went ahead years ago and used a voltage three times that which was in common use, which sounded higher in those days than a hundred thousand volts sounds now, a man who went ahead with a plant of that kind and has made it work, and has been one of the leaders in power transmission work in the West, is Mr. Nunn. So far as I know, Mr. Nunn has never been before a technical society before with a paper on this or any other subject. I think that we are especially to be congratulated on having Mr. Nunn at this time present a history of this pioneer work. This Congress ought to deal somewhat with the past as well as the present and future.

**MR. BUNKER** (*communicated after adjournment*): There seems to be a prevailing idea among many engineers that a rainy or a wet season is something to be feared in the operation of a high-tension line. As a matter of fact, experience has shown that fewer line troubles occur in a wet than in a prolonged dry season, due to the cleaning effect of the rains. Forty to fifty thousand volts have been thrown during heavy rains onto long stretches of dead line with no more disturbance than under normal conditions. The first rain, however, after a duration of dry or dusty weather which has permitted the insulators to be covered with dirt, causes increased leakage due to the mud formed. With proper insulators, a wet season is to be preferred to a drought, so that wet pins have not actually proven to be a disadvantage.

A further cause of the burning of wooden pins other than leakage, is due to the fact that when the insulators are coated with a more or less conducting material, they become condensers of greater or less capacity which reduces the value of the pin as an insulator. The small contact area of the insulator with the pins, increases the density of current flow to an extent which produces heat enough to char the wood. Where this contact area is increased by using a metal pin, or a metal short around the wood pin no burning takes place. The use of insulating materials of various values in series has the same effect here as in other places, where it is more commonly known and breaks, or tends to break down, the insulation having the least dielectric strength. These small insulator condensers simply add to the capacity of the system, and if the small condenser currents can be prevented from causing burning action as by the use of metal connections to the supports, the insulation of the line is thrown back where it belongs, namely to the insulator.

## PIONEER WORK OF THE TELLURIDE POWER COMPANY.

BY P. N. NUNN.

During the winter of 1890, the year preceding the famous Frankfort-Lauffen experiment, apparatus was installed for the first commercial, high-pressure, alternating-current power transmission of the world. From that beginning has grown The Telluride Power Company.

The mining district surrounding Telluride, San Miguel county, Colo., is at the same time one of the most rugged and one of the richest in the Rocky Mountains; but its inaccessibility and the consequent cost of producing power caused the financial failure of many important enterprises in the early days of its history. The statement made in the Annual Report of the Treasury of the United States, in 1901,<sup>1</sup> that "For the growth of its mining industry, San Miguel county is indebted to the Telluride Power Transmission Company more than to any other agency," is borne out by the fact that at the present time all of the important mines and mills of the district are operated by power furnished by this company.

The Gold King mill, situated at an altitude of 12,000 ft., where the cost of fuel for steam power had become prohibitive, was the first to be operated by means of this power. This property had been attached in 1888 to satisfy a continued deficit in operations. Mr. L. I. Nunn, the attorney retained by the owners, found that this deficit was largely due to the enormous cost of power, and that there would have been a handsome margin if power could have been furnished at not more than \$100 per hp-year. Down in a deep gorge of the valley, over 2000 ft. lower, but less than three miles away, two mountain streams formed at their confluence the South Fork of the San Miguel river, offering cheap and continuous power. A stay of proceedings was secured; and, as a means of transmitting this power, cable drive, compressed air and continuous-current elec-

1. Annual Reports of the Treasury of the United States. Report of the Director of the Mint, page 135.



tricity were all investigated. The limitations of each were apparent, while the advantages of alternating current and higher pressures became gradually recognized, and a decision was reached to attempt their use. This decision was due less to the immediate saving in copper, than to a keen sense of the limitation of continuous current, and faith in the final success and ultimate superiority of alternating current.

During the investigation which followed and while selecting apparatus, little but incredulity or ridicule was encountered. Eastern investors in the enterprise were annoyed by predictions of prominent engineers, and discouraged by their insistence, that the experiment would prove a miserable failure and the expenditure go for naught. It was said that there was no alternating-current motor; that oil insulators must be used, and that the line must be fenced in. However, a generator and a motor for 3000 volts and of 100 hp. each were ready for trial in the fall of 1890. Difficulties caused by ice at 40 deg. below zero, by speed control over unusually high water pressure, by avalanche, by blizzard, by electric storms unknown in low altitudes, and many other troubles, now generally forgotten, but then most serious, marked every step of progress. Notwithstanding all of these, unqualified success from the beginning caused gradual and constant growth, until at the present time the Telluride company and its allied industries have six power stations and nearly a thousand miles of line in Colorado, Utah, and Montana.

Following its pioneer power transmission, it made practical experiments as early as 1895 with pressures which have never, even yet, been exceeded, and for three years it operated commercially the highest pressure transmission of the world. Thus the record of its work becomes an important chapter in the history of power transmission; but it must readily be seen that the limit of this paper precludes the possibility of describing all, or even a substantial part, of its pioneer work.

The initial installation, purchased through Mr. F. B. H. Paine, comprised a generator installed in a rough cabin upon the site of the present Ames station and belted to a 6-ft. Pelton wheel under 320 feet head, and a motor at the mill 2.6 miles distant. The two were identical Westinghouse single-phase alternators of 100 horse-power, the largest then made. The generator was separately excited, while the motor was self-exciting. Each carried a 12-part commutator and was slightly compounded through current



FIG. 1.—MAP OF TELLURIDE DISTRICT, SHOWING SYSTEM OF RESERVOIRS, WATERWAYS AND POWER-HOUSES, TRANSMISSION AND DISTRIBUTION LINES.

transformers upon opposite spokes of the armature. The latter were ironclad or "T"-toothed, wound with 12 simple coils in cells of fullerboard and mica. Switchboards were matched and shellaced pine sheathing, and the bases of instruments were dry hard wood. Only voltmeters and ammeters were used, both of the solenoid and gravity-balance type, in black-walnut cases with window-glass fronts. Circuits were closed with jaw switches and opened by arc-light plugs. The line carried two No. 3 bare copper wires, mounted upon short Western Union cross-arms and insulators. The copper cost about \$700, or about 1 per cent of the estimated cost for continuous current.

The main motor was brought to synchronous speed by a single-phase induction starting motor, which received its current at full line voltage. The current taken was more than full-load current of the main motor. This starting motor, even, required starting by hand, its torque being zero at starting, and so feeble at low speeds that when cold it could only with the greatest difficulty be persuaded to pull up to speed its belt and loose pulley. Nor could it at speed start the main motor without help, and even then it became so hot that its short-circuited secondary frequently burned out.

Another motor of 50 horse-power was soon added. While in other respects similar to the first, this motor was intended to be self-starting, with armature and field in series through a current transformer; and on account of its frightful flashing, it was fitted with a special eight-part commutator of non-arcing metal. This feature, however, proving a failure, was soon replaced by a separate starter.

The need of a wattmeter or power-factor indicator not having been at that time recognized, the motor field charge was adjusted for least main current. This current was accepted as having unity power factor, and, therefore, as the measure of actual power.

Everything was extremely simple from water wheels to motors; and, except for lightning, the plant ran smoothly and steadily 30 days and more without a stop. The report made in the East by associates of the enterprise that at Telluride 100 horse-power was being successfully transmitted nearly three miles over No. 3 copper wires with less than 5 per cent loss, was received with the utmost incredulity.

During the autumn of 1892, a 600-hp generator of the same characteristics was installed, and a 250-hp motor for the mill on Bear Creek, 10 miles from the generator. Early in 1894, a 50-hp, and during the fall, a 75-hp motor were placed in Savage Basin, 14

miles from the power-house. The former was soon replaced by a 100-hp motor, and in 1895 a 100-hp motor was set up at Pandora.

Except as to size these motors were substantially identical. The 250-hp motor was badly designed, and the pole pieces were of cast-iron. Its starting motor was insufficient, and was, therefore, soon replaced by one having split-phase secondary with external resistances. Marble with brass trimmings replaced wooden-base instruments, and such elegance demanded highly-polished slat switchboards of paraffined oak. Imposing marble rheostats were mounted at switchboards like keyboards upon grand organs. Fuse blocks, the only protective device, became marble slabs with duplicate aluminum strips. The first synchrophone came with the 75-hp equipment.

Owing to its altitude and geographic position, the Telluride district is peculiarly subject to atmospheric disturbances. Over 100 distinct discharges have been counted within a single hour, and lightning caused more discouragement than any other obstacle. A neighboring continuous-current plant, transmitting a little more than a mile, carried several extra armatures; and even then it was so frequently compelled to close down during the daily storms of the rainy season, that the company was eventually bankrupted. The alternating plant might have suffered a similar fate had it not been for its "T"-toothed armatures and replaceable coils, eight of which were successively burned out and replaced on one motor within a single week. To get a coil into place, and its oak keys driven home, required such bending, clamping, and pounding as inevitably resulted in injury to insulation, and only by the greatest care could replaced coils be made to stand a test adequate to the 3000 volts employed. For protection from lightning, several types of manufactured arresters, then various original devices were tried, ending with a simple gap in series with a score or more of fuse blocks parallel, arranged about a radial commutator switch, turned from point to point as the fuses were blown by successive discharges. From the first these conditions caused the greatest apprehension to the commercial success of electric-power transmission, until Mr. Alexander J. Wurts, during a stay of several months with the company, gave the protection of the now well-known non-arcing arrester.

No transformers were used between machines and line, the largest transformers at first being 2-kw, or 40-light. Aside from the effect of lightning, even to-day 3000 volts upon the winding of small high-speed armatures requires first-class insulation. Frequent ground

were prevented by deep insulating foundations of paraffined wood. To prevent short-circuits within the coils, their cells, just before placing, were poured full of shellac, and the entire armature afterward baked for several days. By this means the 50-hp motor ran a full year without trouble in a room dripping with moisture

A lighting transformer received in 1891 was rated at 5 kilowatts. Theretofore transformers had been rated in lights, and generators in horse-power. This transformer was immersed in engine oil, and marks an epoch in the company's history. Lightning frequently punctured it, causing its fuses to blow, but without other apparent injury. It remained in service for years. All others were soon likewise immersed. Four 500-light, dry Stanley transformers, purchased in 1892 for lighting Telluride, were broken down by the thunder storms of the following spring. When repaired these also were immersed in engine oil, and gave no further trouble during the three years they remained in service.

Alternators were paralleled at Telluride in the spring of 1893, and thereafter they were so operated with full load upon the smaller and regulation upon the larger machine.

Manipulation at switchboards or at brushes involved direct handling of 3000 volts, a rather high switchboard pressure even now. It was a rule that every attendant keep one hand in his pocket while working with the other. It is pleasant to record that during these years no loss of life and but few accidents occurred.

There being no other circuit-breakers, it was necessary, when a motor dropped out of step, to break the circuit with the single arc-light plug. This always drew a heavy, vicious arc, which on the big motor frequently held to the full length of the 6-ft. cable, and then sometimes required a whiff from the attendant's hat. When not broken promptly it frequently involved the entire switchboard and shut down the plant.

Duties of this nature required considerable skill and cool heads, and in order to operate the plant continuously, night and day, 15 or 20 competent attendants were required. To fit young men for these positions a course was arranged during which they were taught something of machinery, of shop-work in metal and wood, and of wiring, insulating, and repairing, while receiving such assistance in daily study as conditions permitted. A technical library, including the electrical papers, and a conveniently-fitted testing-room were always open. Each student was then given a short laboratory course

in graphic treatment of alternating-current theory. This is said to have been the first systematic effort made by a corporation to train its employees for responsible positions.

Although the plant as a whole was an unqualified commercial success, no explanation need here be made as to why it was replaced by the induction system as soon as the latter had been perfected. This marks the limit of the most extensive single-phase, synchronous plant ever operated. With but one or two motors its operation was not difficult; but each motor added to the system brought increased demand for care and skill. The causes of difficulty were not understood then as now, nor was the effect of power factor fully appreciated. Lack of both wattmeters and power-factor indicators left the adjustment of field charges to the judgment of the operators. The power factor of each motor being dependent not only upon its own adjustment but upon that of all, the closest attention and co-operation were necessary, in marked contrast with the simplicity of operation of induction motors. Disturbances due to starting motors were especially trying; and the unqualified success attained, notwithstanding defects of apparatus and system, is attributed now, far more than then, to the skill and vigilance of the operators in this new and fascinating field.

The Tesla system, substituted for the synchronous in 1896, comprised two 600-kw, 60-cycle, 500-volt, two-phase generators, direct connected to wheels under 600 and 900 feet head, respectively, and an equal capacity of raising and reducing transformers and of two-phase, 220-volt induction motors. The 12 100-kw, step-up transformers were connected in pairs, two-phase—three-phase, for three-phase, 10,000-volt transmission. These transformers were worthless; all broke down within a year, and one or more were always undergoing repairs. Break-downs occasionally caused sufficient explosion to lift a cover, or splash the oil. The woodwork soon became saturated, and hot metal from the near-by main fuses frequently started fires, endangering the wooden power-house. A masonry transformer-house in two compartments was, therefore, constructed, and into it the transformers were moved,—this being the first known case of isolation of oil transformers on account of fire risk.

The power-house at Ilium, situated six miles below Ames on the same stream and using the same water, was built in 1900, and contains one 1200-kw, revolving-field, General Electric generator, di-

THE NEW YORK  
PUBLIC LIBRARY  
ASTOR, LENOX  
TILDEN FOUNDATIONS



FIG. 2.— AN OPEN-AIR SWITCHING JUNCTION.



FIG. 3.— TOWER ON SUMMIT OF CAMP BIRD DIVIDE.



rect connected to two impulse wheels under 500 feet head. Transmission lines extend both to the Ames station and to points of distribution, providing the insurance of duplicate transmission. Any section of line can be cut out for repair, or either power-house shut down, without interrupting the service. Junctions, other than generating and distributing points, are equipped with open-air switches, mounted upon standard line insulators and operated from platforms similarly insulated, and have proven invaluable.

Junction-houses at distributing centers provide for a branch line to each customer, which is equipped with switches, fuses, and a set of five record-making instruments — a voltmeter, 2 ammeters, and 2 wattmeters. The power company thus secures upon its own property a continuous, accurate, and satisfactory record of each load.

The long spans crossing canyons and divides surrounding Savage Basin may be worthy of note. These divides are bare ridges at an altitude of 13,000 ft., inaccessible in winter and swept by frequent snow slides. Spans up to 1150 ft. are used in order to reach safe points for supports. A number of these supports, although simple and inexpensive, have stood for years without repair. The longest span is of No. 1, hard-drawn copper, supported by  $\frac{1}{2}$ -in. plow-steel cable, both being carried by the same insulators. The deflection is approximately 35 ft. on a slope of 31 deg. Another is of  $\frac{3}{8}$ -in. soft-iron cable 1120 ft. long, and has been in service five years. A third, 660 ft. long, is of hard-drawn copper only, having 25 ft. deflection. The strain insulators in all cases are a series of the usual line insulators and pins upon a longitudinal arm hinged to permit adjustment to span motion. They are simple, inexpensive, and entirely successful.

A 10,000-volt, underground transmission was put in operation at the Gold King mine in 1896. Power was carried through an unused tunnel 1300 ft. long, upon bare copper conductors 12 in. apart on standard line insulators, to a deep mining hoist equipped for electric power. The tunnel was always dripping with water, but no trouble was experienced during the several years of operation, although slight brush discharge or halo was at times observed.

An interesting installation to which power is furnished is that of the well-known Camp Bird, Limited, near Ouray. Nineteen motors and rotaries, in sizes up to 150 kilowatts, drive crushers, Huntingtons, concentrators, compressors, pumps, and hoists, aggregating in all about 1000 kilowatts. Two underground transmis-

sions, each a mile in extent, are in operation. Continuous current at 550 volts from two rotaries and a 650-ampere-hour storage battery operate three deep-mine hoists of 150 horse-power, and an installation designed by Mr. C. S. Ruffner, now engineer of the Utah department, makes use of the alternating current transmitted at 10,000 volts through paper-insulated, lead-covered cable, for the purpose of operating two 50-hp pumps.

The success of the original plant prompted the manager of the company, Mr. L. L. Nunn, to institute a search for other water powers in the West, finding as a result that such powers were very remote from available markets, requiring much longer transmissions than theretofore used. Voltages higher than from 10,000 to 15,000 were not in commercial use, and were regarded as merely problematical; but two important water rights, already acquired in Utah and Montana, would have been worthless at such pressures. Mr. Nunn, therefore, determined in 1895 to undertake at Telluride an experimental transmission at higher voltages, to be installed and operated as a practical test for power purposes, and to determine, if possible, the problems peculiar to long distances and high pressures.

Two identical 75-kw, oil-insulated transformers were installed in the autumn of 1895, one at the Ames station and the other at the Gold King mill. They were designed for pressures varying from 15,000 to 60,000 volts by convenient steps. A separate pole line was equipped with three circuits of different characteristics, upon three types of insulators.

Measurements with many special instruments were made, embracing the different voltages, styles of insulators, conductors, and distances between them, and the conditions peculiar to the various phenomena met at every step. Observations upon a wide range of atmospheric conditions were made by means of United States Weather Bureau apparatus at either end of the line. The commercial feasibility of high pressures was demonstrated by the successful operation of the Gold King mill during a great part of the year at pressures from 30,000 to nearly 60,000 volts, as well as by continuous electrification for nearly a month during dry weather, of a three-mile telephone circuit upon telegraph insulators, at pressures rising from 10,000 to 40,000 volts.

The change of the system from single to polyphase terminated actual transmission experiments. The reducing transformer was moved to the station, and another equipment designed for polyphase

tests was ordered. The remaining time was devoted to open-circuit losses, and to the verification of measurements previously made. This work continued until August, 1897, when construction was begun upon the Provo plant.

Much of the data obtained from these experiments was incomplete, requiring caution in its use, due largely to the time and study required in solving, step by step, the problems and difficulties met at every stage of the work. However, that much of value was obtained is shown by the subsequent successes at Provo. Sufficient had been learned to warrant the commercial adoption for the first time of 40,000 volts,—nearly thrice the voltage of any previous plant; to lead to the manufacture of transformers which, after seven years' continuous operation, are still in daily service; to determine the design of the Provo-type insulator, the method of line construction, distance between wires, and the importance of wave form, and to make possible this great advance in long-distance, high-voltage transmission.

This experimental work, as clearly appears from the foregoing facts, was begun, carried on, and finally utilized by the Telluride company in the regular and necessary course of its growing business; yet it must be added that important services were rendered by Mr. V. G. Converse, under whose direction the transformers had been designed and constructed, and who participated throughout the greater part of the work during all the experiments with actual high-pressure transmission, and subsequently by Mr. Ralph D. Mershon in the elaborate instrumentation and laboratory practice, including a notably ingenious method of reading high-tension losses upon low-tension circuits, devised by him and used in substantiating the accuracy of the earlier measurements; also that different types of insulators were contributed by the General Electric and the Westinghouse companies and by Mr. Fred M. Locke on account of their friendly interest in the work.<sup>2</sup>

The original plant at Provo contained two 750-kw, 60-cycle, 800-volt, three-phase General Electric generators, direct connected at 300 r.p.m. to twin horizontal turbines under 125 ft. head; a six-panel Wagner switchboard, two banks of oil transformers, and two outgoing circuits. All contents thus in duplicate were assembled in two complete, independent units, designed for operation inde-

<sup>2</sup> An interesting account of this work and some of the technical results may be found in Mr. Mershon's report, quoted in a paper read by Mr. C. F. Scott before the A. I. E. E. at the Omaha meeting, July, 1898.

pendently, or in parallel, at both high and low pressure. Prior to the power-factor indicator, a device which answered a somewhat similar purpose was installed, consisting of a wattmeter on the low-pressure paralleling bus with current coil in one bus and shunt across the other two. This indicated cross-current, and was used in the adjustment of field charges. Transformers were each of 250 kilowatts, 800 to 40,000 volts, star-connected at both high and low pressure, with neutrals grounded.

Triple-pole air-switches and 4-ft. fuses formerly connected each bank of transformers with its transmission line. One form of air-switch, opening 6 ft., contained no metal except conductors, and was composed entirely of paraffined wood and rawhide, without porcelain, glass, or other insulator. Others were sliding frames carrying line insulators.

During the first year of operation the transmission comprised a single 32-mile line to one receiving point at Mercur, where the arrangement was similar to that at the power-house, save that two reducing transformers were connected two-phase — three-phase, grounded neutral, for 220-volt, two-phase induction motors. The Provo-Eureka line, 42 miles long, carries seven-strand aluminum cable equivalent to No. 4 copper. The Eureka-Mercur cross-line, 28 miles long, equivalent to No. 5 copper, was added to complete the triangle thus formed and permit cutting out either of the three sides without interrupting service.



FIG. 5.—MAP OF UTAH VALLEY, SHOWING POWER-HOUSES AND TRANSMISSION AND DISTRIBUTION LINES.

The Logan plant was completed in 1901, containing two 1000-kw, revolving-field alternators, direct connected at 400 revolutions to double-discharge twin turbines under 212 ft. head. This plant is connected with the Provo system by duplicate lines over 100 miles long, passing the cities of Ogden and Salt Lake. The Provo and Logan plants are thus operated in unison through nearly 200

THE NEW YORK  
PUBLIC LIBRARY



FIG. 4.—LONG SPAN AT CAMP BIRD DIVIDE.



FIG. 6.—THE LOGAN POWER-HOUSE.

miles of transmission. Distributing points at Mercur, Eureka, Bingham, Salt Lake, and Provo are also junction points of the duplicate lines, equipped with switches in each incoming line, as well as in circuit with the transformers, so that in case of threatened trouble the patrolman can, without delay, have his section cut off for immediate repair without interrupting service.

The three conductors of each transmission form an equilateral triangle 76 ins. between wires, carried by a 7-ft. cross-arm and the top of the pole. Extra long pins raise the insulators from 6 to 12 ins. above cross-arms, are of selected locust, kiln-dried and immersed from 6 to 12 hours in hard paraffine at 150 deg. C. Cross-

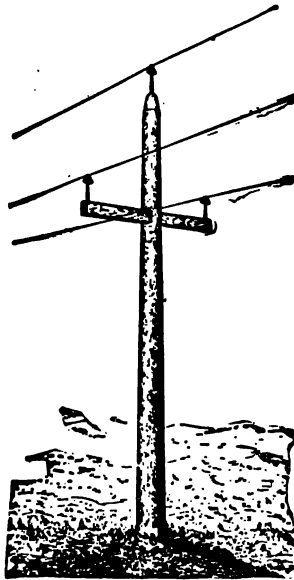

FIG. 7.—PRESENT ALL-WOOD POLE CONSTRUCTION.

arms are of Oregon fir, kiln-dried, and soaked in boiling bitumen. Those upon the first line were attached in the usual manner with metal braces. The burning of cross-arms and poles on account of broken insulators, during prolonged wet weather, occurred most frequently at these braces. When the next lines were built in 1899, treated wooden braces were substituted, with results so favorable that all metal braces were soon replaced. It was still observed, however, that even light leakage seemed to concentrate around the lag bolts, carbonizing the wood and finally loosening the bolts.

For the Logan lines of 1900 and all later lines, therefore, the cross-arms were mortised through the poles and wedged and pinned with hard wood — thus discarding all metal except conductors. This construction was originated by Mr. A. L. Woodhouse, who, upon the close of the high-pressure experimental work in Colorado, of which he had charge, became and still is superintendent of the Utah department. It has proved amply strong, not expensive, and during the four years' operation of the 400 miles thus constructed very few poles have been burned.

Provo-type glass insulators, designed by Mr. V. G. Converse, have been used throughout. Many have broken, but these have usually shown the effects of guns or stones. In fact, there has not been a single breakage, except in one lot improperly annealed, clearly due to either internal or dielectric stresses. It is difficult to see wherein any other insulators could have done better, unless bullet-proof. College laboratory tests to the contrary notwithstanding, leakage losses are inappreciable except during severest storms, and then not serious where insulators are unbroken. It is a mistake to suppose that Utah climate is favorable. During the rainy season it is as wet as any, and the alkali dust of the so-called salt storms is as trying as sea-coast spray. At times dense volumes of this impalpable dust from the Great Desert are accompanied by clouds or fog. In this damp, sticky state the dust completely covers to a considerable depth the under, as well as the upper, surfaces of insulators, as well as poles, cross-arms, and pins. Over these surfaces streamers gradually creep until, meeting at the pole, they break into an arc, like that which was photographed by Mr. C. E. Baker, the line patrolman at Mercur, and which has several times been published. A quick turn of the generator rheostat at the critical instant breaks the arc without interrupting service of induction motors.

The arrangement of power-houses and transmissions already described is such that the opening of paralleling switches may resolve the system into a single transmission from 100 to nearly 400 miles in length with a generator at each end, yet side by side. If one generator be reversed, synchronized as a motor with the other and loaded by its water wheel, any length of transmission may, by manipulation of a paralleling switch, be alternately cut in and out between them. Since switchboards and instruments are connected, measurements made are immediately comparable. In this



manner losses and power factor may be measured, and the corrective effect of charging current observed.

Solid aluminum wire, first used in 1898, was slightly alloyed to increase strength, but proved worthless, breaking repeatedly with square, glass-like fractures. It was at once replaced with commercially pure, seven-strand cable, still in use. Similar cables have generally been employed for subsequent lines, while spans have been successfully increased to 180 and 200 ft., with less deflection than usual with copper.

The experience with oil transformers for 10,000 volts at Telluride, and the refusal of manufacturers to give any guarantees whatever for other transformers for higher pressures, led the Telluride company, when undertaking this 40,000-volt transmission, to manufacture its own. The first equipment was made at the Wagner Company's works under designs and supervision of Mr. Converse. The later ones were made by the Converse Transformer Company. When erected, the oil in the tank and the transformer in an oven were slowly raised to, and then maintained during 24 hours at, a temperature of 125 deg. C. The transformer was then immersed in the oil, and both continued at the same temperature for a further 24 hours.

As bearing upon the question of fire risk due to oil transformers, it may be of interest to note that of the large number of these high-pressure transformers used during the past seven years, chiefly in isolated sub-stations containing much wood and seldom visited, all but four are still in operation; that these four were destroyed by fire of doubtful origin, and that only one transformer has required repair other than change of oil.

The plant at Norris, Mont., designed and constructed in 1901, by Mr. O. B. Suhr, Superintendent (now resident engineer of the Ontario Power Company), contains at present two low-speed 1000-kw units. A duplicate transmission of 60 miles conveys power to the city of Butte. These lines, as well as both raising and reducing transformers, were designed for the use of 40,000, 60,000, or 80,000 volts. Longer pins are used than in Utah, and conductors form a triangle of 108 ins. While producing the present limited amount of power, and awaiting a suitable insulator, the lower voltage has been used.

In conclusion, it may be said that the Provo plant—the first transmission at more than 16,000 volts—while undertaken materially in advance of the art, and not exempt from its share

of troubles, has, nevertheless, been fully successful as a financial venture, and not without value in the progress of the science. Long periods of perfect operation, monotonous in their uneventfulness, have proven beyond question the success of high pressures for long distances. The new and larger power-house at Olmsted, at the mouth of Provo Canyon, completed this season, is modern in every detail. It contains three 3600-hp generators, operating under 340-ft. head. Air-switches and fuses are everywhere giving place to oil-switches with time-limit automatics, and constant reconstruction to meet its increasing demands keeps the system as a whole abreast of present practice. Thus The Telluride Power Company, while again and again a pioneer in power transmission, must not be associated alone with the experimental methods of early days, but may, in the future, be found still engaged in progressive, practical, pioneer work.

#### DISCUSSION.

MR. BUNKER: There is one point I would like to ask, if I may, and that is, how large a wire could be used, for mechanical reasons entirely, on that entirely wooden construction?

MR. NUNN: The construction used in Utah is considered safe for wires up to No. 3-0 or 4-0. That in Montana, designed for 80,000 volts, employs pins too long for such large sizes. By adapting the dimensions and design of both pins and cross-arms, it may be possible to make all-wood construction suitable for any size of conductors. It would not be difficult to show that the paraffine permeates the pins. A 4" x 4" piece of oak several feet long has been permeated, as shown by chemical tests upon a sliver taken from its center. This cannot be done by the usual method of boiling in paraffine, but while requiring care and exactness, has been accomplished by the method previously described. The 40,000-volt circuits from the Provo power house pass through the wall in bushings consisting merely of double flexite tube within paraffined oak tubes 5 feet long, having 1-1/2-inch walls. The bushings are fully exposed and during storms are always dripping, yet have never given trouble. The all-wood switch mentioned has four feet of paraffined oak between 40,000-volt wires.

MR. HUMPHREY: I would like to ask whether the poles have ever been treated — that is, the top of the pole? Pins have been treated, cross-arms have been treated, and it seems to me to be practical to treat the upper ten feet of the pole, rather than to abandon the wooden construction and go in the steel-pole construction altogether. I would like to ask if that has ever been tried?

MR. NUNN: No attempt has been made to paraffine poles, but they have been treated to some extent with hot bitumen, especially at their tops and upper pin holes.

**CHAIRMAN SCOTT:** Three weeks ago to-day I spent a most profitable and pleasant day in the Provo power house at Olmstead, which Mr. Nunn has described to us. Mr. Nunn has introduced a new method of high-tension wiring, by running the high-tension wires through fibre tubes. This makes a remarkably neat and compact construction for the high-voltage work. The whole power house and its surroundings are laid out in a very excellent way. There is at this plant excellent provision for the young men who are in attendance at the power house.

**Mr. NUNN:** In the early days, when every synchronous motor required two or three attendants for its 24-hour service, it became necessary to provide opportunity for non-technical but bright young men to learn enough about the apparatus and sufficient of the subject generally to fit them for these positions. The training begun at that time has never altogether passed, and there has ever since been something in the way of a student course. In connection with the new plant at Olmsted, special provision has been made in the way of quarters, lecture rooms, laboratories and a gymnasium for extending this feature and for giving it a permanent character and home. The purpose is to conduct post-graduate research side by side with practical design, construction and operation of engineering works, whereby young men may undergo that critical transition from the receptive college student to the executive, practical engineer of affairs.

**CHAIRMAN SCOTT:** There is another side of this power transmission work, and of electrical engineering work in general, which has not come into our discussions until introduced by Mr. Nunn just now. It is the human side. All the power transmission systems that we have now, transmitting, at what might be termed high voltages (10,000 volts or over), something like a million-and-a-quarter of horse-power, in which we had no experience ten years ago, have made an evolution not only in pins and insulators but also in men. The men have had to be developed; they have had to go from one kind of work to assume responsibilities in larger work, with more exacting and unknown conditions, and if the curve of electrical activity is going to keep on increasing, more men for the work we are doing now, and more men for undertaking these new problems must be developed. The colleges are doing much. I have met during this week a host of young, enthusiastic, energetic college professors who are here in touch with the work of this Congress and of the exposition, and who are going back to keep on grinding out young electrical engineers. Those young men were not appearing fifteen years ago; the colleges were not then making them; the college did not have the facilities. Now it is turning them out in great numbers. Manufacturing companies are taking them, operating companies are taking them, not only in power work, but telephone and other companies, and I believe the important thing now, the big evolution, in a way, in electrical work, is the development of young men who are going to be a big factor in this work in the next ten years. In the company with which I am connected men are received and given a training for a couple of years, such as that of which Mr. Nunn speaks, and I was surprised a few days ago to see in a list of the men who have been received within the last three or four months that practically fifty institutions are represented by from one to

half-a-dozen men. Now, not quite so large quantitatively, perhaps, but in the same general line qualitatively, Mr. Nunn is going to take young men and give them opportunities for running a station and learning the operation of a power transmission system; and the elegance of his station and of the cottages and facilities which he is building up at Provo mean that the young men are going to be well taken care of in other ways besides electrically.

## THE BAY COUNTIES POWER COMPANY'S TRANSMISSION SYSTEM.

---

BY L. M. HANCOCK.

---

In treating of this subject it is taken for granted that the majority are familiar with the details of the Bay Counties Power Company's system which now forms a less important part of the plant of the California Gas and Electric Corporation.

Only an outline of the general and controlling features will be given, dealing more at length with the organization of the forces to operate the plant and to carry on construction and repairs.

Considering organization, the plant falls into the following three natural divisions:—

1. Generating.
2. Transmitting.
3. Distributing.

The first comprises all water systems and power houses. The second, all high potential transmission lines and their fixtures. The third, all substations and low potential lines and their fixtures.

The main features of the plant and the attention they require are as follows:

*Diverting Dam.* Log crib, rock filled, 40 feet high and about 200 feet long on the crest. The intake and headgates were of concrete and very massive and ruggedly substantial throughout. The dam needed and could get attention only during periods of low water; then it was examined thoroughly each year and whatever repairs were necessary were made preparatory to another season's submergence which lasted the greater part of the year. The gates and intake needed some attention which was all given by the flume men.

*Main Flume.* Seven feet wide, six feet deep, seven and one-half miles long, through one of the most rugged pieces of canyon in the State. This was the most difficult part of the system to construct on account of inaccessibility. It was also one of the most difficult parts of the system to keep up to a high standard of repair, and on

account of local conditions must be very carefully watched to avoid danger and to care for the numerous accidents as they arose. All must be inspected each day to take care of many little things that needed prompt and immediate attention though the major repair work was attended to once a year.

*The Main Penstock* at the end of this great flume was built of concrete and besides receiving water from the main flume was arranged to be fed in an emergency with water from Lake Francis through 9000 feet of 36-inch wooden stave pipe, 1/2 mile of natural channel and 3000 feet of rapid flume. This penstock delivers water to Colgate and to the old Brown's Valley irrigation system. On account of previous troubles with the pipe lines, variations in the flow of water, and the great dependence put on this plant, watchmen were stationed at the penstock and held there constantly.

*The Five Thirty-Inch Pipes* carry the water from the penstock and deliver it into the receivers back of the power house. The pipes were very carefully installed and need only an occasional inspection, which is given by the power house superintendent or foreman after severe storms early in the spring and late in the fall.

Being covered for the greater part of the way, this inspection course only takes in exposed portions and surface indications, local conditions of retaining walls, breakwaters, etc.

Water is distributed from the receivers to the 16 water wheels through small pipes and suitable gates. All the small pipes, connections, gates, etc., near the power house get regular attention from the forces employed there. Inspections are frequent and every item has continual care.

The power house equipment is as follows:—

*Generators.*

- 3 2000-kw, 240 r.p.m., 3-phase, 60-cycle, 2400-volt, inductor.
- 3 900-kw, 360 r.p.m., 3-phase, 60-cycle, 2400-volt, inductor.
- 1 720-kw, 286 r.p.m., 2-phase, 133-cycle, 2400-volt, inductor.
- 2 50-kw, 800 r.p.m., exciters.

Suitable tangential water wheels with deflecting nozzles are directly connected to each generator and exciter. The low-potential switching is made as simple as possible and only such instruments are centralized as are needed to control the plant. The balance is scattered about the building near the apparatus to which they belong. Oil switches are used exclusively for the 2400-volt circuit.

at which voltage all the machines operate. *The Transformers* are all oil-insulated and water cooled, the majority of them are 750 kw, but there are a number of smaller sizes. They all require almost no care and being in the power house have constant attention.

All low-potential wires and cables are run in a subway, while all the high potential wires and connections are overhead in the gallery. Originally an immense amount of wood was used in mounting the high-potential switches, lightning arresters, etc.

This construction was all destroyed in a fire, March, 1903, and has been replaced by a brick and tile and steel construction built up on the cellular system.

The unique feature of Colgate is the number and variety of very high potential circuits radiating from the plant. The following table gives a list of them:—

Name of circuit.	No. of circuits.	Length in miles.	No. of pole lines.	Material.	Phase.	No. wires in each circuit.	Cycles.	Kilovolts.
Bay .....	2	140	2	$\frac{3}{4}$ Copper ..... $\frac{1}{4}$ Aluminum ..	3	3	60	40-50-60
Sacramento ....	2	61	1	60 M: Alum..... 1 m. Copper ...	3	3	60	40
Oroville .....	1	28	1	Aluminum .....	3	3	60	40-50-60
Marysville .....	1	28	1	Part } Alum .... } Copper ..	2	4	60	15
Nevada .....	1	19	1	Copper.....	3	3	60	24 } On same 24 } pole line
Nevada .....	1	16	1	Copper.....	2	4	133	

This variety of service can only be handled successfully at the power house end by either using individual transformers for each line, by using a great many high-potential switches, or a combination of the two methods. The first, however, makes it necessary to have a great deal more transformer capacity than is necessary for the loads handled. The second method was pioneering to an alarming extent. Therefore the third method was adopted planning to use as few of both devices as possible. The odd phase and voltage lines had to have separate transformers which were operated from the low potential switches and were to all intents and purposes a part of their respective lines. The growth of the plant was such that the odd voltage three-phase lines could not be avoided; however it was planned ultimately to have these all operated at the same tension.

The question of high-potential switching was one of very great moment and must be solved, yet it is not to be trifled with.

There were four designs of switches employed, as follows:

*First*, an emergency switch, which when open or closed was perfectly safe but would not stand being opened under full voltage and heavy current. This was simply a blade about thirty inches long with jaws mounted on large insulators which were carried and held in place by suitable frame work, the blades being pivoted to one of the jaws. These switches were suitable for cutting out a dead line or would open the full voltage of a thirty mile line if there were no load on it. They were also adapted for cutting in and out banks of unloaded transformers but with full voltage on. They were used in series with main switches, lightning arresters and other devices that must be taken out of service occasionally without having to shut down, and were also employed for temporary work and testing.

*Second*, the Stanley switch, which was arranged to break the arc in a tube filled with plaster paris. This served the purpose in the absence of anything better, but was clumsy, slow of operation and often out of repair.

*Third*, the oil switch with horizontal break. This switch was not installed where it had to handle heavy loads, but there were some very severe tests put on it which it stood remarkably well. These tests consisted of opening a dead short at a distance of 100 miles from Colgate with full generator capacity behind the line.

*Fourth*, the oil and water switch. This switch in its original form was put under extremely severe tests which it stood wonderfully well, opening 25 dead shorts on a 40 K.V. line in quick succession, some of which were 240 miles from the generator via the pole line. However the design of this switch was not suitable to the duties required of it. During a severe lightning storm it broke down and was not replaced. The consensus of results pointed to the horizontal break oil switch as the one that stood the test of actual service the best of any.

*The Substations* and the wiring for them were as various as could be imagined. The transformers as a general thing were wound so that they could be used anywhere on the system, and taps were brought out so that either three-phase or two-phase circuits could be fed from them. Three transformers were generally used and taps were brought out from the winding so that the voltage



could be varied as needed. When two-phase service was given from three transformers, it was found unsatisfactory for motor work on account of the regulating coils varying the phase angle. In several cases a single transformer was installed for single-phase service in small towns, the high-potential side having one wire attached to one of the line wires and the other to a ground plate, very satisfactory service being given in this way in small towns.

The substation buildings varied from steel frames covered with corrugated iron in important locations, to an ordinary wooden building in some of the small towns.

*The Switchboards* in a few of the larger stations were quite complete, but in the majority were very simple, there being generally apparatus to meet only the most urgent needs. High-potential switches were usually provided in each station; in the larger ones they were either Stanley or horizontal oil break; in the smaller stations, the cheapest kind of a long knife switch. Devices were usually provided outside to cut the line clear from the building. Ten substations were put into service when the line went into commission. In three years this number had increased to twenty-six. The majority of these stations needed little attention.

The organization of the forces to operate this system was a most difficult task. There was no experienced class to draw from so men had to be educated for the work, and meanwhile the system had to be kept going. There must be more men than was actually necessary, yet in the trying out of so much new apparatus there was no telling how many men would be needed for emergency work. There must be no delays in repairing breaks for financial men the country over were watching the results and a little parsimony might mean thousands of dollars lost in depreciated securities.

The water system consisted of the following items in the order of their importance:

First: Main section, dam, flume, and penstock.

Second: Auxiliary section, Lake Francis system.

Third: The middle section from Colgate penstock to the Brown's Valley power house.

Fourth: The lower section below the Brown's Valley power house.

The Lake Francis auxiliary system is placed second in order of importance, though as it exists it is not worthy of the place for it is so far removed and the conduits are so small that it does little

good as an auxiliary. The writer urged very strongly when the original plans were made that they provide a penstock reservoir of sufficient size to operate the plant for a few hours at least. Had this been done the operating expenses of the hydraulic system could have been kept at less than one-half of what was found to be necessary. In other words, an average of ten men are now needed if the system is kept up to the proper standard, while with the reservoir only four would be needed; a saving of \$5,400 per year which capitalized at 5% equals \$108,000.

This sum, plus the actual cost of the Lake Francis system would have been amply sufficient to put in the reservoir suggested.

This is an excellent illustration of how the design may affect the future operating expenses.

The conditions facing us were these: The system as installed must be utilized to its fullest extent and at the least cost. With this understanding the following organization was adopted:

Superintendent — Foreman:

Main Section:

6 Flumemen.

2 Penstock watchmen.

Auxiliary Section:

Permanent watchman at lake.

One winter watchman at end of wooden stave pipe.

Middle Section:

4 Ditchmen.

Lower Section:

1 Ditchman.

This force handled all the work well except the yearly repair work and cases of extreme emergency. Then extra men were brought in from other parts of the system or from outside sources.

While the flume was new there was no great trouble in making the natural repairs, but as it grew older, timbers began to rot, twist, and crack and repairs of magnitude had to be made. Many places were patched up and from the very nature of things had to be left till an opportunity came for thorough work. As long as the planking that actually held the water remained intact the balance of the repairs could be made with extra care and expense, but when a rock would come rolling down the hill and knock out the under-

winning or smash a hole through the flume itself, it was simply a case of shut down till damaged parts could be replaced.

This shutting down of 10,000 horse power, even for a few hours, was no idle matter and a thing every one dreaded.

The superintendent of the water system held an anomalous position; while taking his orders from the general superintendent direct, he must at the same time take orders from the Colgate superintendent in regard to the water furnished for the power house.

He must get over the whole of his system at least every month and must be on hand to take care of any emergency that might arise on the main flume, and there were many places on this important section that had to be watched continually in order to meet difficulties half way.

The foreman devoted all of his spare time on the main section, supervising repairs, looking after the placing of new material, maintaining discipline and ever holding himself in readiness for emergencies. The six flume men did little but patrol the flume; minor details they took care of however and always helped in cases of an accident. Two men were kept on watch at the penstock all the time.

These could do but very little except to stop any leak that might occur in the neighborhood, keep rubbish off the rack at the entrance to the penstock and attend to the adjustment of the various gates in the neighborhood. If there were a break in the flume, one or both were expected to assist in its repair. There was an elaborate system of floats and electric bells installed for detecting low water at various points a mile or more above the penstock but these devices were seldom of any value except to talk about.

When anything happened of a serious nature, the water always slacked away so quickly that everything, flume, penstock and all was emptied before the water wheel nozzles could be closed.

There were 14 gates to close these nozzles, each gate requiring ten minutes to operate it; hence with only three men on shift to do this it was quite a simple matter to predict what would happen.

On the middle section four ditchmen were employed who did practically all the repair work on their beats besides making their tour of inspection each day. This part of the system consisted of 20 miles of ditch and flume. It carried only 1,200 inches of water and was an old settled piece of work.

The lower section of the water system consisted of 22 miles of

ditch and a few short flumes and inverted syphons and as it furnished only some irrigation water and some little desultory mining, it was of so slight importance that one man handled it successfully. Each year a force of from ten to twenty men were put on for a few weeks doing general repair work. At this time every feature of the system got an overhauling and whatever repairing it needed. Thus the whole system was put in readiness for another year of hard service.

The handling of this water system while very exacting, involved nothing new or strange. Materials such as men were familiar with were used and the handling of flumes was no new work for Californians with but this one exception; for power purposes without any storage, the full head must be kept running all the time, while the ordinary service to which flumes are applied water can be turned out at any moment it may be desired without causing any serious trouble.

The water system was peculiar in that none of the men ever saw any of the customers of the company and in fact seldom saw any but their immediate fellow workmen. Their cabins were in very isolated places and they seldom met any of the officers of the company. There was a monotonous life with but little to inspire them. Their business was to deliver water and as long as that was done no one complained nor did they praise.

The Colgate power house was the center of the whole system and the whole aim of the operators was to put out energy.

This was dependent, (a) on the water system delivering water to them; (b) on their ability to utilize it and to keep in working order the apparatus in their care; (c) on the line department keeping the lines in order, to transmit what they generated; and (d) somewhat, on the distribution system being able to receive and deliver to the customers what the line department handed over to them.

After the power house force had kept its apparatus in repair and in operation, they must, in order to succeed, be in harmony and in close touch with all the other parts of the plant. Hence the emphasis on a complete and efficient system of communication. This was not so evident on the water system, for immense systems of flumes and ditches have been and are operated without any means of communication other than messenger or mails.

Items (a), (b) and (d) did not interest the power house force; they must concentrate on their own troubles.

The principal item on which success depended here was the repairs of damaged or worn-out apparatus, so in order to facilitate this a large supply of new material and spare parts were kept on hand and a large and well equipped machine shop was installed and men were appointed on the force that could utilize these tools to their full value.

The forces here, though dependent so much on the others for success, were never allowed to get the idea of covering their own mistakes by attracting attention to the troubles of others. The handling of this power house had only these three features that distinguished it from all other large power houses.

First. It must feed numerous high voltage lines of various voltages, phases, cycles and lengths.

Second. It must run in parallel with other large plants that were many miles distant and operated at different voltage and phase.

Third. Its service reached almost every known business where power can be utilized, and there was not a moment in the year when a great many were not exceedingly anxious for energy.

While this was the case, the only feature of uncertainty at the start was that of the high-potential lines, switches, lighting arresters, etc., but after a year's experience it was found that to this apparatus could be charged no more than a proportionate share of the troubles.

It was decided that for Colgate there should be the following organization:

**Superintendent ranking as a division superintendent:**

Foreman:

Assistant Foreman:

3 Shift bosses.

3 Operators.

3 Oilers.

Machinist.

Apprentice to Machinist.

2 Telephone Operators.

Repairmen as needed.

The superintendent, while not having absolute authority over the flume superintendent, in the one question of water supply his word was final. Besides this he was a man of much wider knowledge and experience which was all of very great value to the company

ing material, looking after the repair work, and working between trips with the line superintendent.

The telephone expert was in a position that he had to work under nearly all the superintendents though he was nominally under the line superintendent. His was a study in harmony. His work extended from one end of the plant to the other and as the name indicates devoted the greater part of his time to the solving of difficulties, designing and installing protective devices and working the telephone system so the highest efficiency could be obtained. He was always supplied with material and men on call. If communication could not be maintained, the plant could not be operated.

The superintendent of construction was utilized almost exclusively on new work, and hence had little to do with the operation of any of the lines, except when they first went into commission. He was expected to use every opportunity to study developments in order to assist in any way possible to the general success.

In order to care for the line thoroughly, patrolmen enough were put on so that they had an average of 14 miles to cover each day. In the mountains and marshes the beats were shorter and in the valleys longer.

The whole line must be put into shape so every part of it could be reached. In the hills trails must be dug, creeks bridged and barns built for horses. In the marshes and flooded lands boats must be provided, everywhere gates must be put in fences and above all certain communication must be provided.

The work required that the patrolmen should not do very much of the actual labor connected with the upkeep of the line. They carried a number of tools and a portable telephone and were always called on in emergencies. They must report on duty in the morning, get over their beat at a slow enough gait to be sure of the condition of every detail, report several times during the day and report off duty at night. Usually by the time they had attended to all the above, they had accomplished a very good day's work. Most of these men used saddle horses; in fact there were only one or two beats where a wheeled vehicle could be used to advantage. Material was stored at various places along the line so that it could be reached conveniently in case of trouble. The work of patrolling was so new that there was no class of trained men to draw from so each patrolman had to be educated. In fact the officers in charge had to make an unusually close study of it, living with it almost

night and day for two years. A host of questions were asked and few of them answered before the line went into service. As the answers came they must be recognized quickly and the work pushed accordingly.

It looks a little strange to put on a repair gang almost before an installation has gone into actual service. This was on account of the work being so new that there was no experience to guide those who designed the various parts of the equipment.

Some of the questions to which we had to learn the answers in the field, were:

To what extent will the wooden supports of the line be destroyed by the high potential used?

How will the insulators, which were a composite glass and porcelain, stand the actual strain of operative conditions?

How much of the insulator can be broken off before it must be removed from the line?

How much dirt can accumulate on an insulator before it must be cleaned?

How noisy can an insulator get before it is dangerous?

What effect will fogs produce?

What effect will rain produce?

If a line gets shut down in a rain storm, can it be started up again and with what difficulty?

How will long spans stand up?

What will be the result of using steel for line supports?

As the work progressed answers came to all of these about as follows:

Wood pins were destroyed by the hundreds near salt water; cross-arms a few, and poles only two or three in the course of three years' service.

Glass is not suitable for high-potential insulators under the conditions as they exist on this system. An all-porcelain insulator has been and is being substituted for the composite insulator as fast as conditions will permit, especially near salt water.

The insulator first installed had so little margin of safety that if it were broken at all it was ordered removed from the line.

If only a small piece were chipped out of the edge the risk was taken for a time.

The only place where we had trouble with the accumulation of dirt on insulators was near salt water and cement works.

There may be a good deal of noise at an insulator on a wood pin for many weeks and not much damage result, but it should be watched closely. With a steel pin and a wood cross-arm this noise will not be anything serious except in some unlooked-for place, due to local conditions. These should be watched closely on general principles.

Ocean fogs cause the burning of very many wood pins, while cross-arms and poles suffer but little.

Fogs a few miles back from salt water do not affect either pins, cross-arms or poles.

Rain is Heaven's own blessing on a high-potential transmission line. It cleans the insulators and stops a good deal of the damage to wooden supports. This is true of salt water districts especially. The first few drops that fall after a prolonged dry spell causes a good deal of a display which soon passes however and all is quieter and better than it was before. This display does not affect the power house load to an appreciable extent nor does it affect lights or motors.

The starting of this line in a rain storm never caused the slightest trouble, in fact in changing from one line to the other full voltage has many times been thrown instantly on the dead line during heavy rain storms without the slightest disturbance that any one could detect.

The experience has been that long spans are preferable in almost every case. On a mountain line built about two years ago some very long spans were used. One was 1,800 feet with the regular line conductor, a 350,000 cm stranded aluminum cable, and it has given the best of satisfaction.

Every indication is that steel should be used for high-potential line supports from the ground up to the insulator throughout the system.

The substations and distribution work were handled almost entirely by the local men, nearly all of whom were under a separate management. A superintendent of this work was maintained whose duties were mainly to advise the local men in regard to the handling of the company's property and to see that it had proper care.

At the majority of the substations a man would be on duty only for a time during the evening when the lighting load was on, unless there was important high-potential switching to be done.

The low-potential distributing systems gave very little trouble



and it was very seldom that they were not able to utilize the current available.

The men for all the positions were very carefully selected from the whole country. The repair and construction forces were used as training schools for men for permanent positions and the foremen of these gangs were selected with this specially in view. These forces were used too as places to lose out undesirable characters.

The following ideas were advanced to guide in the handling of the men:

First. Harmony must be maintained.

Second. There must be a definite sequence of authority to prevent working at cross purposes.

Third. Each man must respect and obey the officer immediately over him.

Fourth. Each man had the assurance that his advancement depended on himself alone; that all the higher positions of the operating, repair and construction forces were open to the men handling the plant if they would fit themselves for them.

Fifth. The longer the time of service the better the pay.

Sixth. A sufficient number of men must always be kept to insure excellent service, but there must never be so many that each man's time will not be fully occupied.

The officers and the sequence of their authority for the whole system were as follows:

**General Superintendent:**

**Water System Superintendent:**

**Foreman.**

**Flumemen.**

**Repairmen.**

**Emergency men.**

**Auxiliary Section:**

**Lake watchman.**

**Winter watchman on wood stave pipe.**

**Middle Section:**

**4 ditchmen.**

**Lower Section:**

**1 ditchman.**

**Colgate Superintendent:****Foreman:****Assistant Foreman:**

3 Shift bosses.

3 Operators.

3 Oilers.

Machinist.

Apprentice to Machinist.

2 Telephone operators.

Repairmen, etc.

**Superintendent of Lines:****Assistant Superintendent:**

Patrolmen.

**Foreman repair gang:**

Linemen.

Laborers, etc.

**Superintendent Construction:**

Engineers.

Surveyors.

Chainmen.

• Rodmen.

Axmen.

**Foreman:**

Linemen.

Teamsters.

Laborers, etc.

Time-keeper.

Freight agent.

**Superintendent Substations.**

Substation operators.

Local managers of business districts.

## SOME PRACTICAL EXPERIENCES IN THE OPERATION OF MANY POWER PLANTS IN PARALLEL.

---

BY R. F. HAYWARD.

---

Local conditions and force of circumstances have developed in the United States and Canada several large power systems, consisting of a number of long-distance transmission plants operating in parallel, and supplying power for all conceivable purposes over wide areas of territory. The growth of these systems has covered a period of nearly 10 years, and the time is opportune to review the lessons learnt in their upbuilding. The mistakes, technical and financial, which were necessarily made in the pioneering of long-distance transmission of power have been turned to profit, and plans are now being followed out along comprehensive lines, to meet the demands of a market which has grown more rapidly than ever was pictured in the dreams of the early promoters.

Three large systems of this kind have grown up in California under the control of the Los Angeles Edison Electric Company, the Standard Electric, and California Gas & Electric Companies; the State of Utah is almost covered by the lines of the Utah Light & Railway Company and the Telluride Power Company; in Canada the Montreal Light, Heat & Power Company is operating a large parallel system; and in the State of New York the Hudson River Power Company is making great developments in this line.

The technical journals are full of articles describing and illustrating these plants and the physical difficulties encountered in building them, but very little has been written about their operation. A description of the difficulties and troubles encountered and overcome in the course of eight years' operation of the transmission plants in the West would, in the hands of a skillful writer, form a most instructive and exciting story. It would be a tale of fights with the forces of nature in the great valleys and mountains of the West; fights against ice, snowslides, floods and rockfalls, brush-fires, windstorms and lightning, where time was always on

the side of the enemy. It would be a record of simple devotion to duty in the difficult and dangerous situations on the part of all the operators.

In Utah, where the author's lessons in transmission have been learnt, the first water-power plant was started in June, 1896, and from the very first was operated in parallel with the steam plant in Salt Lake City. Other plants were constructed immediately after, and by consolidation and reorganization were joined together into one system. The Pioneer Power Plant at Ogden was run in parallel with the Big Cottonwood Plant, 50 miles away, for the first time in March, 1898. Since then there has been a continuous growth of the business, until the beginning of 1904 found the two systems of the Utah Light & Railway Company and the Telluride Power Company running in parallel, covering a district 160 miles long from north to south and including six water-power plants, two steam plants, 420 miles of high-tension transmission line, and nearly 500 miles of circuit. The maximum demand on the two systems was about 10,000 kilowatts, and the load consisted of lighting, street railway, and power for all kinds of service, including flour mills, cement works, brickyards, smelters, air-compressors, cyanide mills and other mining enterprises.

A complete discussion of all the features of parallel operation would involve the consideration of almost every phase of power transmission. Certain points, however, stand out in importance above all others, and they will be discussed in the following order, viz.:

1. The organization of the operating staff.
2. The means of communication.
3. Load factor, and the economical distribution of load between steam and water-power stations.
4. Speed regulation.
5. Voltage regulation and power factor.
6. Arrangement of high-tension lines, switches, and transformer stations, etc.
7. Sudden disturbances on high-tension lines, from lightning, etc.

The statements made in this paper do not, of course, necessarily apply to systems operating under different conditions to those here referred to.

### 1. THE ORGANIZATION OF THE OPERATING STAFF.

The success of a transmission company depends more upon the organization and efficiency of its operating staff than on anything else. From the lowest to the highest there should be an ambition to rise to higher responsibilities and a readiness to do anything possible, even to the extent of taking some personal risk, in order to keep the service going through storm and accident. The staff will be composed of technical engineers and artisans. The technical men should have an all-round engineering foundation, and must be especially trained in the art of observation—mere electricians are useless in a large power plant. The artisans should be encouraged to study with correspondence schools as much as possible. Even a helper or stoker who does not endeavor to prepare himself for a higher position should be dropped out. In the operation of many power plants in parallel, more than in any other business, is it necessary that there be perfect harmony between all departments and confidence between operators and their superiors.

The chief operating engineer should have jurisdiction over all power-houses, transmission lines and distributing stations, and should be held responsible for the delivery of the power to the service mains. His headquarters should be at the receiving end of the system, from which points he or his assistants should direct all operations. All operating engineers should be technical men who know every corner of the system. The superintendents of power stations should be held responsible for all that pertains to their stations, whether water power or steam plants, and should be trained artisans, rather than technical engineers.

All the transmission lines operated by one company should be under the care of one man who should have under him a capable staff of patrolmen. It does not pay to use any but skilled linemen for this work, and character is as important as skill.

### 2. THE MEANS OF COMMUNICATION.

It is impracticable to operate many power plants in parallel without private telephone service between all power-houses and substations. The whole telephone system should be laid out and operated with as much care as the transmission lines. Every important station should have two lines of communication, for when an accident occurs, a power-house may be inoperative until communication is established. It is good practice to build independent

telephone lines parallel to the transmission lines, but this is by no means necessary, as perfect service can be obtained with telephone lines properly arranged on the same poles, either with or without a grounded neutral on transmission line, and the indications on a telephone are invaluable in giving warning of impending troubles, in locating break-downs and in indicating high-volt surges. The requirements for good telephone services are: good insulation, both on transmission lines and telephones; strong construction, so that no storm will break the wires; good protection to operators against accidental high voltage; and transpositions on both high-tension and telephone lines. Without sufficient insulation on the transmission lines for the voltage carried, a telephone line on the same poles is simply inoperative. For the telephone line itself the best of insulation can be obtained by using porcelain insulators designed for 2000 volts lighting service and it pays to do this. All wiring inside and outside of buildings should stand a puncture test of 2000 volts. All plugs and jacks should be replaced by knife switches. Knife switches should be arranged so that both bell and telephone can be cut off from the line. The telephone should be connected on only when in use. For protection of telephones and operators in case of cross with high-tension lines, a simple spark-gap to ground between two large metal cylinders has been found quite effective. These should be placed in a fireproof cell or outside the building. Strength is best obtained by using porcelain insulators and No. 8 iron wire. No copper wire of less size than No. 6 B. & S. will stand the stress of weather without breaking, and iron works very well.

Good service can be procured by placing telephone wires close together and transposing once in half a mile. With high-tension lines untransposed there is considerable induction between telephone line and ground. On a 45-mile 28,000-volt line in Utah, the voltage between telephone line and ground from this cause is about 1000, but in spite of this the telephone service is perfect even in wet weather. Of course any one ground on the telephone line renders the line inoperative, but the transposing of the high-tension line will probably remove this difficulty.

### 3. LOAD FACTOR.

The economical distribution of load on a number of plants operating in parallel is dependent on the load factor of the system. For any given set of conditions, covering cost of construction of

water power and price of steam coal, there is a certain load factor at which it costs the same to generate by steam as water power. If the load factor is less than this amount it pays best to generate by steam, if greater by water. To obtain the greatest returns from a water-power plant every cubic foot of water available must be utilized economically. On a stream where no storage is possible this means a constant load. If there is sufficient storage to take care of daily fluctuations, a water-power plant may be run economically on a very low load factor, with a maximum use of the water equal to from two to three times the minimum flow. In irrigation districts however, it is necessary to build a storage reservoir below the power-house as well as above, in order to equalize the delivery of water to the ditches. By a proper combination of water-power plants (some with storage, others without), and a steam plant, all proportioned properly in relation to one another and to the load factor, it is possible to utilize every cubic foot of the water in the minimum season and to obtain an economy that is greater than either by steam alone or water alone. With such a combination, the water-power stations which have no storage can always be run at full load; and when water is scarce, the steam plants can be run at full load all the time and the peak can be taken by the water-power storage plant; whereas when water is flush the steam plants can be used for peak loads and emergencies only or can be shut down altogether. This principle can be extended beyond the fluctuations of a day, to the variations of a season or a year, and advantage can be taken of the fact that the low-water season of one stream does not coincide with that of another.

All this is being done in Utah, and during low-water seasons not an available drop of water is allowed to pass the Utah Light and Railway Company's power-houses without generating power, and that without interfering with irrigation.

The load factor of a mixed system of lighting, street railway and general power and mining service is not higher than 35 to 40 per cent and the tendency is not upwards. Even in smelters or mining camps where operations are carried on day and night the load factor is never much greater than 40 per cent; and while flour mills, pumping plants and some other operations may be continuous, there are always many intermittent services to affect them. It is this low load factor that limits the economical distance of power transmission more than anything else.

#### 4. SPEED REGULATION.

Good speed regulation is absolutely essential to the success of a large power system, but it is dependent on the ratio of the total variations to the total load to a much greater extent than engineers generally care to admit. In small systems supplying power for very variable loads, good speed regulation is hard to obtain with the best of governing arrangements. In large mixed power systems, however, conditions are conducive to steady speed, for though variations of load produced by street railways, elevators, hoists, etc., may be large and rapid, no change in speed can occur without changing the speed of every generator and motor and every piece of machinery on the system. In addition to this great total inertia, every change in speed of machinery is accompanied by a corresponding change in load, which is another factor tending to constancy of speed. On the other hand a large motor load introduces variations very great in proportion to total load during the dinner hour and at starting time in the morning.

In every steam or water-power plant there is a certain time limit between the variation of the load and the application of the power to meet it. This time limit is dependent upon the design of the governor, the inertia of the moving parts and the inertia of the steam or water. When operating plants in parallel, the inertia of the moving parts is the inertia of the whole system.

If a number of power plants operating in parallel were each equipped with the same kind of governor, each governor being adjusted to act on the controlling mechanism at the same time, it would be found that an increase of load would be first taken up by the steam plants, next by the water-power plants which were running on a constant stream with impulse wheels and deflecting nozzles, next by turbine plants with short pipes and ample fore-bay, and a long time after these, by impulse wheel or turbine plants where the regulation was performed by varying the velocity in long pipes. In order to make such an aggregation of plants govern simultaneously, so that each should take its share of load variations, it would be necessary to adjust the governors of all to the time limit of the slowest plant. In practice it has been found almost impossible to do this, and it will generally be found that the governing of a system of this kind is done from the largest water-power plant, or by a steam plant, or possibly by both. When a steam plant is running in parallel with water-power plants it is



generally necessary to have an adjustable dashpot on the governor to make the action slow, otherwise the steam engines will have to take up all the variations.

The solution of a difficult governing problem is now being attempted on the Telluride Power and Utah Light & Railway Company's systems which are paralleled together at Salt Lake City. It is required to deliver a constant amount of power from the former to the latter system, while at the same time each has to be governed for its own variable load. To do this with speed governors alone is a physical impossibility, for if all the governors could be adjusted to work within the same time limits the aggregate load variations of the two systems would be shared in proportion to governing capacity on each; while if the governors are not adjusted to work together, the quickest acting governors will take up the total variations on both systems. In either case there must be a variation in the power passed between the two systems. The problem might be solved by governing each system by independent electric governors, regulating in accordance with the variations of load on each system respectively. The arrangement of lines and distributing points makes this impracticable however. The only practical solution of this problem lies in the direction of increasing the amount of power delivered from the one to the other system until the variations caused by the governors bear a small ratio to the total. This problem may at any time become important to two large systems operating in adjacent territories.

#### 5. VOLTAGE REGULATION.

The requirements for good voltage regulation on a large system running several plants in parallel are:

1. Good speed regulation.
2. The control of the whole system by one engineer operating from the main receiving and distributing center.
3. Good inherent regulation of all generators.
4. Lines of ample carrying capacity and small drop.
5. Ample transformer capacity at all points where inductive apparatus is used.
6. Low-tension distributing systems laid out for small drop in feeders, transformers and secondary mains.
7. The proper control of idle currents between stations.

8. The regulation of the power factor, on stations or on distributing system.

If these points are all attended to, good service can be given with a mixed load consisting of lighting, railway and power service; if any one of these is neglected, bad service must result on part, if not on the whole, of the system. The first and second requirements have already been discussed here. As regards the fourth requirement it may be pointed out that a transmission system having a large drop is justified only when the load is constant and the loss of power immaterial from a financial point of view. The fifth requirement is also fully appreciated now and all transmissionmen know by experience the importance of providing ample transformer capacity for induction motors which have to be started against load. With a given transformer capacity, the resistance-in-armature type of motor will start against a much heavier load than the squirrel-cage type, simply because the large starting current of the latter type reduces the voltage so much more than the small starting current of the former. In regard to the sixth requirement it may be stated that automatic feeder regulators of the three-phase induction type are being used with satisfactory results for regulating the 2000 and 4000-volt feeders in Salt Lake City. These regulators not only compensate for drop in feeders, transformers and secondaries, but also for speed variations caused by slight accidents or short-circuits on the system.

A great deal might be written on the subject of the seventh and eighth requirements. The operating engineer at the main receiving center should have the control of the voltage, while the power-house operators should take care of the speed. In a mixed system of lighting, railway and power service, the maximum loads at different points of the system occur at different times. Consequently it has been found best to carry approximately constant voltage at the receiving stations, to compensate at the power-house for drop in transmission lines only, and to compensate for variations of drop on the distributing feeders by regulating apparatus at the receiving end. No special difficulty has been found in regulating for a mixed load of lights and induction motors. A variable load driven by an induction motor has a useful tendency toward self-regulation for the low-power factor at light loads causes nearly the same drop of volts as the high-power factor at full load.

A line of great capacity, such as the Telluride Power Company's

40,000-volt lines, requires a heavy inductive current at light loads to compensate for the rise of volts due to the capacity. On a single 80-mile line from this company's Logan power-house, delivering 750 kilowatts at Salt Lake City, at a power factor of 100 per cent, the power factor at the power-house is about 60 per cent.

On a mixed system, the power factor can be kept at any value between 90 and 100 per cent by the use of synchronous motors driving railway generators; but for the regulation of voltage, synchronous motors are not of much value unless used for that purpose alone, because when loaded with work current they have not sufficient current capacity for regulating. Unless synchronous motors are under the control of the power companies' operators, pumping and other regulating difficulties will be caused by wrong adjustment of exciting current.

Sixty-cycle rotaries are too sensitive to be used as regulators and to operate them in parallel without pumping, variations of speed and voltage must be very small. If any trouble occurs on a 60-cycle system it is generally aggravated by rotaries.

When operating in parallel, cross-currents between power-houses introduce conditions which may seriously affect the voltage regulation. If the exciting current of the power-houses is not properly adjusted, some will tend to produce higher voltage at the receiving end than others and idle currents will flow which will be lagging with respect to the former and leading with respect to the latter. The amount of these currents is dependent upon the relative difference in excitation, the load and the line constants. These idle currents may be eliminated in two ways; first, by adjusting the excitation of the several power-houses; second, by voltage regulators placed in circuit between the transmission lines at the receiving end, which can be adjusted to maintain that difference of voltages between lines which is required to prevent the flow of cross-currents.

Formerly the desired results could only be obtained by trial and experience. Now, however, by the use of power-factor meters on every generator on the system, the adjustments can be made with accuracy to meet any conditions of line or load. The power-factor meter has become an indispensable adjunct in the operation of all synchronous machinery on large systems.

The fact that the excitation of the power-houses depend on variable conditions on different parts of the system, seems to point

to the impracticability of using any automatic device for controlling exciting currents on large parallel systems.

#### 6. THE ARRANGEMENT OF TRANSMISSION LINES, TRANSFORMER-HOUSES, ETC.

While break-downs on transmission lines cannot be altogether prevented, it is possible to so nearly approach continuity of service that even the exacting requirements of a smelter can be met. This can only be done, however, by the exercise of the greatest care in

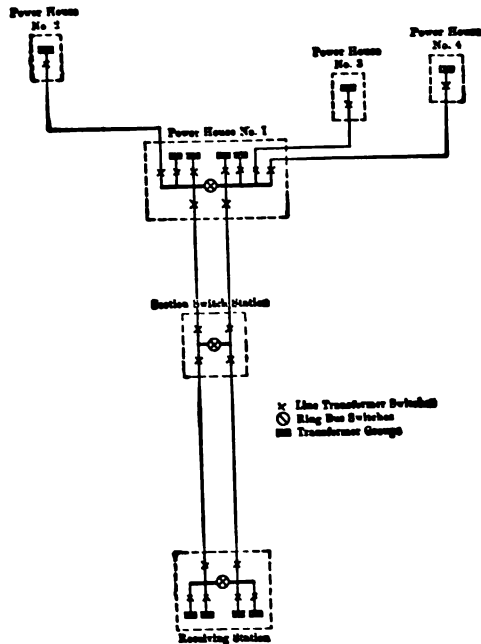

FIG. 1.—GENERAL ARRANGEMENT OF HIGH TENSION LINES AND SWITCHES FOR A NUMBER OF POWER HOUSES IN SAME LOCALITY SUPPLYING POWER TO A DISTANT DISTRIBUTING CENTER.

the arrangement, construction and operation of the switching apparatus, transmission lines and transformer-houses. Nothing but failure will result if the transmission lines are not mechanically strong and well insulated, but good construction and duplication of lines and power-houses are of little avail unless the general layout of the lines and switches is of the simplest kind.

The trend of experience in line construction points to the use

of long spans of stranded copper with steel towers, porcelain insulators and rigid iron pins. There is a tendency to increase rather than to diminish the cost of construction, so that the cost of copper and, therefore, the choice of voltage, is by no means the greatest consideration in designing transmission lines. In locating a line it should be remembered that accessibility for patrol and repairs is more important than saving of distance. Transmission lines should be constructed so that nothing but outside interference will break them down. Between every important power-house and distribut-

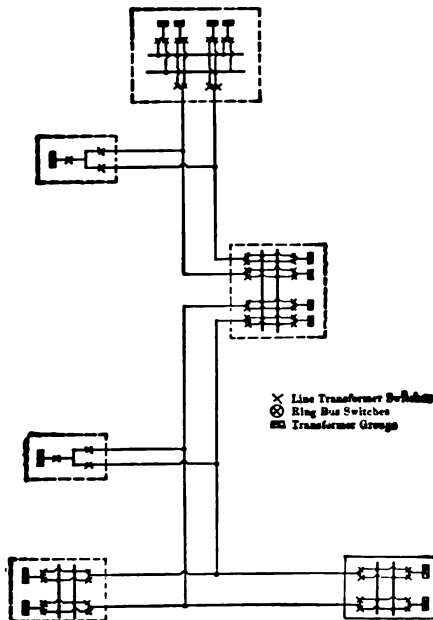

FIG. 2.—GENERAL ARRANGEMENT OF HIGH TENSION LINES AND SWITCHES FOR A NUMBER OF POWER HOUSES AND RECEIVING STATIONS SCATTERED OVER A LARGE DISTRICT, LAID OUT ON DUPLICATE MAIN SYSTEM.

ing center there should be at least two lines, and sometimes two routes are advisable. On very long transmissions there should be section-switch stations (see Fig. 1) so arranged that portions of the line can be cut out for repairs without putting the whole line out of service. Unless this is done, each line must be designed to carry the maximum load transmitted with a small drop. Very long lines will seldom be financially justified unless a very considerable business can be done on the way. On the other hand, isolated sub-

stations on an important line are a serious detriment to service unless the business done will justify a good section-switch station with an operator constantly in attendance.

The best arrangement for the transmission lines of a system operating many plants in parallel depends on the location of power plants with respect to the present and prospective point of distribution. In systems consisting of several power plants located near one another and transmitting power to a distant point,

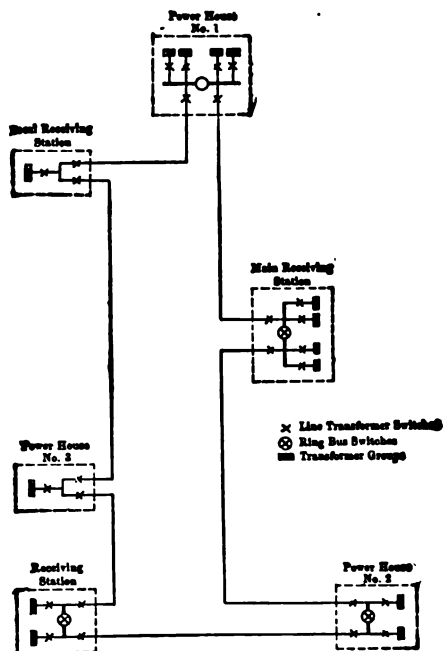

FIG. 3.—GENERAL ARRANGEMENT OF HIGH TENSION LINES AND SWITCHES FOR A NUMBER OF POWER HOUSES AND RECEIVING STATIONS, LAID OUT ON RING MAIN SYSTEM.

arrangement does not materially differ from that of a single power house. In this case it is usually best to treat the smaller plant generating units of the most important power-house, as represented in Fig. 1. In systems where the power-houses and distribution points are scattered, the transmission lines will take either the form of a duplicate bus to which will be connected all the power-houses and receiving stations, as shown in Fig. 2, or else will be laid out in the form of a ring main as shown in Fig. 3.

Whether for station bus-bars or transmission lines, the ring main divided into sections as shown in Figs. 3 and 5 has been found to be the most practical arrangement to operate. If the business between any two points on the ring becomes so important as to warrant a duplication of lines between them, the system can generally

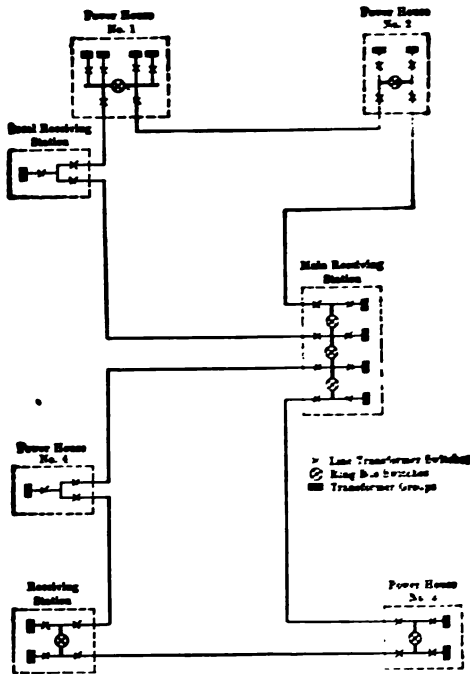

FIG. 4.—GENERAL ARRANGEMENT OF HIGH TENSION LINES AND SWITCHES FOR A NUMBER OF POWER PLANTS AND RECEIVING STATIONS, LAID OUT ON THE RING SYSTEM, WITH TWO RINGS PASSING THROUGH THE MAIN RECEIVING STATION.

be resolved into two or more rings all passing through the important center as shown in Fig. 4.

Fig. 5 shows the ring system as applied to power-houses and transformer stations, from which it will be seen that it is practically equivalent to a group-switch system. With this layout any group of transformers, feeders or generators with its corresponding transmission line can be separated from the rest of the system in an instant by opening the high and low-tension ring bus switches. This arrangement in a transformer-house is ideal when each group

of transformers has capacity to carry all the power that can be delivered over the corresponding line.

Short-circuits on transmission systems may be caused by failure of transformers, lightning arresters or line insulation, or by outside interference by nature, man or beast. Their frequency is a measure of the efficiency of construction and management. They will vary in severity from those which cause just a flicker in the lights to those that may shut down a large station. Short-circuits on the low-tension side of receiving stations will never seriously affect the system as a whole. Short-circuits on transmission lines which can be burnt off, will seldom throw power-houses out of step and should cause very little interruption. Even very severe short-circuits will not throw power-houses out of step unless occurring on the line between them or very close to one of them. In a well-laid-out parallel system no failure on transmission lines can cripple the whole system, and rotaries and motor-generators will

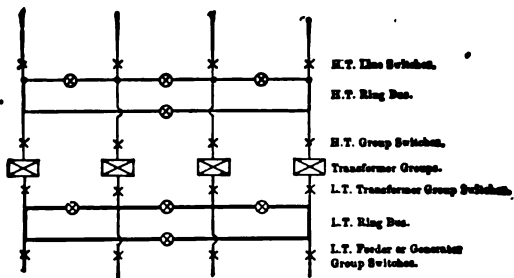

FIG. 5.—GENERAL ARRANGEMENTS OF HIGH-TENSION AND LOW-TENSION BUS BARS AND SWITCHES FOR GENERATING AND RECEIVING STATIONS, LAID OUT ON THE RING SYSTEM.

stay in step through many shorts. It is when a short occurs which cannot be burnt off, or which throws power-houses out of step, that the efficiency of layout and operating staff is tested. It is not the short-circuit which hurts the service, but the stopping of machinery and time taken to get under way again.

Under normal conditions there is no difficulty in cutting generators and synchronous motors in or out of service, or in synchronizing power-houses on lines at any point in the system, but when everything is thrown out of step or stopped by a severe short-circuit, synchronizing is altogether too slow. All synchronous motors should be self-starting from the alternate-current end, or at least



should be designed so that the alternate current can be switched on after they have been given a preliminary spin. Two-hundred horse-power synchronous motors have been regularly started without any compensators for a long time in Salt Lake City. Power-house generators can be synchronized very rapidly, but time can be often saved by running them to speed approximately and switching on to the live circuit before closing the exciting circuit. In the Los Angeles system, it is a rule to open the exciting circuits on all generators and synchronous motors, except at the largest station, whenever a short-circuit occurs. As soon as the trouble is cleared, the main station generators bring up speed and volts, the other generators and motors are pulled into step and the station operators close the exciting circuits. This is a very good method of starting, but is not applicable to every condition.

It is in clearing short-circuits on transmission lines, that the ring system as illustrated in Figs. 1, 3, 4 and 5 is so superior to the duplicate bus system shown in Fig. 2. When a short-circuit occurs which does not clear itself at once, the ring bus switches can be opened up so as to resolve the system into two or more separate parts complete with their own power-houses, lines and loads. This immediately locates the trouble, the short-circuited line can be quickly cut out, and the load on the short-circuited section transferred to the adjacent portion of the ring without any delay for communicating between stations. Automatic circuit breakers can be used for these ring bus switches with great advantage, but except on unimportant branch circuits, they can be used nowhere else on a transmission system of this kind. Reverse-current circuit breakers for cutting out a short-circuited line will not work, for under normal conditions on a parallel system power may be coming from either direction at any time.

High-tension air switches have played an important part in the building up of transmission systems. They can be made simple, strong and safe for outdoor operation even at 40,000 volts, but at best they are makeshifts and must be replaced by oil switches which have proved reliable in service on the highest voltage now in use.

So far as the operation of large parallel system it appears that the question of transformer delta connections and grounded neutrals are by circumstance rather than by design. A del



that the disturbances increase in energy beyond what should be expected from the increased capacity of the lines.

The disturbances due to short-circuits, switching and static charges are, however, trifling, compared with those that may be set up by lightning discharges. It must be confessed that no real progress has been made in apparatus to protect against these disturbances, and today the choking effect of the transformers and the high insulation of the windings, both of the oil and air-blast type, is their own best protection. This has been demonstrated over and over again by discharges from terminal wires of transformers to case, across sparking spaces many times greater than the total gaps on the lightning arresters, and in spite of the protection of choke coils of the most recent design.

The disturbances set up by lightning discharges range in severity from those that can be easily taken care of with existing apparatus to those that may wreck a station. The latter seldom occurs, but when they do, the result is like an explosion and no plant in a thunderstorm district can claim to be protected. A lightning discharge which strikes the line shatters insulators and poles and is intensely local in its action, for the simple reason that the voltage is so high that line insulation must break down close to the point of discharge.

The sudden raising of the voltage of the line, to the break-down point, will, however, send static waves along the line. The voltage of these waves and the distance at which they may be effective depends chiefly upon the strength of line insulation. With wooden pole lines, the insulation to ground may be very high in dry weather and under these circumstances the static wave may be of very high voltage. Some waves have passed from line to ground across a 12-in. dry air-gap on a 40,000-volt line. This has occurred on several occasions without damage to transformers.

It follows, from what has been written above, that the extending of a system to cover a very large area, while exposing it to the action of more storms, and consequently increasing the number of the disturbances, does not by any means increase the severity of the secondary disturbances which are limited by the insulation of the line.

Transformers should be insulated between layers of high-voltage windings to withstand shocks that will break down the line insulation. Money spent on extra insulation inside the transform-

ers will probably bring better returns than the same expenditure on outside protective devices.

It seems probable that steel towers will be ideal for protecting stations and apparatus from the more severe effects of lightning disturbances.

There are many other points bearing on the subject of this paper to which a reference only can be made here.

While it is generally cheaper to store water-power than electricity, some transmission plants cannot give satisfactory service without storage batteries, and on nearly all it pays to use them to a greater or less extent both on account of regulation and emergencies.

It will be asked whether it pays to operate so many plants in parallel instead of generating power in one or two large plants. This depends entirely on local considerations, and the answer is sometimes yes, sometimes no. When there are convenient water-powers it will nearly always be found that a combination of water-power and steam gives the most economical results. The opinion, however, cannot be too strongly expressed, that a depreciation charge of 10 per cent per annum, at least, should be made on the whole cost of construction of both steam and water-power plants. The neglect to do this may be hidden by reorganizations or abnormal growth of business, but it means financial failure sooner or later. It is extraordinary how often people, who ought to know better, will shut their eyes to this fundamental law of engineering finance.

As regards the bearing of parallel operation on future developments, it may be pointed out that it would be possible to-day to operate a string of steam and water-power plants in parallel from the Atlantic to the Pacific Coast and to supply power to trunk railroads with so few interruptions that train service could be as punctual as it is today on steam roads.

The author's acknowledgments are due to many engineers who by advice, suggestions and investigation have helped in the solution of many difficult problems but most of all are they due to the members of an operating staff upon whom has fallen the burden of all the troubles and difficulties experienced in the course of nine years' work in transmission in the State of Utah.

## DISCUSSION.

**CHAIRMAN SCOTT:** The papers of Mr. Hancock and of Mr. Haywood are open for discussion. They reveal another side of station operation which men in the laboratory or in the engineer's office would hardly discover. They show the workings of the operating system, Mr. Hancock's paper in particular dealing so much in detail with the operating force of a large system, throws an excellent light on that side of the problem. Mr. Hayward has done just what he was invited to do and has given some of his experiences from his own work on the system with which he is connected.

**Mr. P. N. NUNN:** While the problem of lightning arresters for high voltages has not been fully solved, it seems hardly fair to say that nothing has been accomplished. While arrester service in Utah has been far from satisfactory, no high-voltage transformers have ever been lost, and but trifling repairs occasioned through lightning. If it is possible, as suggested, to get higher insulation for a slightly increased first cost, without sacrifice in the characteristics of the transformer, it is undoubtedly wise to do so. Quite aside from lightning, however, effective and reliable arresters are needed to protect from those other disturbances incident to long distance transmission, which interfere with the use or perfect operation of automatics and similar devices. Mr. Hayward's paper advises "The control of the whole system by one engineer operating from the main receiving and distributing center," and says "The operating engineer at the main receiving center should have the control of voltage, while the power-house operator should take care of the speed." This strongly suggests that in the case of a power company with many customers, its plant should be operated for or by some one customer. In the present instance, the producing system is operated for constant voltage, and the customer has been advised and is now preparing to receive his power through induction regulators, which will put within his reach the control desired both as to voltage and power factor.

**Mr. C. S. RUFFNER:** Mr. Nunn has asked for a statement of the results of this experiment. The experiment has not been carried far enough along yet to give any very complete results. A small regulator was put on one of the circuits connecting the two systems, being adjusted for only the part of the load that the regulator could take care of, and it showed such improvements in the power-factor that we feel there will be no doubt about the feasibility of controlling the entire load with a regulator of this kind. The difficulty has been that the ratio of the transformer connections between the two systems has been such that it made the receiving system take a leading current, which was, of course, added to the charging current of the lines, and gave at the generating station an extremely heavy current overload. By means of this regulator, bringing the voltage of the two systems into the proper adjustment, it will be possible to let the charging current from the one system supply the lagging component of the load on the other, giving more nearly a unity power factor at all generating stations, and consequently giving a little better voltage regulation on that account. The experiment will be very interesting, although we have no doubt about what is going to happen

after the regulator is installed. The regulator that is to be ordered is of the three-phase induction type, adjusted by hand. At present we have made no arrangement for any automatic adjustment on account of the difficulty of being able to tell by the regulator which way it is to be moved; that is, the regulator is not able to determine which system is delivering too high a voltage when the voltage at the regulator is too high. Any automatic adjustment would, of course, have to be made by a device controlled by a power-factor indicator, and it is probable that the regulator will have to be adjusted so that the load may be taken at different power-factors at different times of the day, varying with the power-factor of the different classes of load at the different hours. It is the ordinary commercial regulator; the small one that was put in was what is known as the L. R. I. regulator, and worked very nicely with a small load. The only effect of this regulator is to give a controllable variation in the ratio of transformation, and the regulator seems to offer the most convenient way of varying this ratio, rather than having any variable taps on the transformer. Of course, that could be accomplished by the variation in the transformer taps.

CHAIRMAN SCOTT: One word in regard to the operation of the two systems which may clear up a point concerning which a member has made a query. The two systems may, in a way, be regarded as having the same function as two alternators running in parallel. Those two alternators are to deliver power to the system. The power that they deliver will depend upon the power that they get, which in this case will depend upon the position of the governors of the waterwheels. The amount of power given by the water to the wheels goes through the apparatus and into the electric system. Conversely a change in the power which is delivered by one alternator, or by the other, or by one system of power houses, or the other system of power houses, will depend on the amount of power developed by the waterwheels, so that the governing of power must be done in the hydraulic part of the system. It cannot be done through speed governing of different parts because all the parts must run at the same speed. Again, when two alternators are running in parallel, they may deliver a leading or a lagging current. They may deliver the out-of-phase-current equally, or one may deliver more than the other. If there are lines to be charged, one generator may do all the charging or the two may work together. If there be induction motors to be supplied with lagging current, one may supply all the current or the other may supply all the current or the two may work together. That adjustment depends not on waterwheels but on field charges and the voltages produced. And to make one generator or the other carry more or less of the out-of-phase-current, it is necessary to change the voltage through adjustment of the field charge. Now these two systems are operating conjointly in one sense and independently in another. If one is to be operated at a little higher voltage than the other when the two are linked together, the only way to link them satisfactorily is by transformation; that is, through a transformer, by letting one run at one hundred per cent and the other at say a-hundred-and-ten per cent and making the adjustment through the regulator; and as that adjustment changes from time to

time through the day, it is a matter which must be under control. If independent regulation of voltage on the two systems is attempted by other means, the out-of-phase-current between the two systems is apt to be troublesome.

Mr. NUNN: It may make this matter clearer to explain that the line in question is nearly 200 miles long, having a large charging current, supplied equally, we may say, by generating stations at either end, so that, at the center point — Salt Lake City — only work current necessarily flows. Although the Salt Lake system has a large lagging component within itself, it may take its purchased power at unity power factor, but if its voltage drops below that of the transmission, this entire charging current may be drawn from the terminal stations to the Salt Lake system, to combine with the lagging component at that point, thus raising the power factor at all power houses, but reducing the power factor of the purchased power. The same thing may go further, and in either direction, and under normal operation the conditions are very unstable. This may be entirely controlled through proper attendance at the regulators.

Mr. R. S. HUTTON: I do not quite understand this. If the delivered load on one system has a heavy lagging component and the other has a heavy leading component, putting the two together, it seems to me instead of lowering the power factor on both of them — in other words, giving them both heavier current — it would result in counteracting one another, and they would both have less current than before.

Mr. NUNN: It is true that under a certain fixed condition there might be unity power factor at all generating stations. In this particular instance, however, the power company has other lagging current to provide for which takes up all the charging current, and therefore has contracted with this customer to maintain a unity power-factor.

Mr. HUTTON: I might mention one other point. I understand the idea they have in getting the two voltages of the receiving stations the same, is that they can put them together without having one system disturbing the voltage of the other. We are practically doing the same thing, only instead of using the induction regulator, we prefer to use the regulator heads on the transformers, for the reason that the induction regulator is a very expensive machine, something like \$13.00 per kilowatt for a 200-kilowatt size.

## THE MAXIMUM DISTANCE TO WHICH POWER CAN BE ECONOMICALLY TRANSMITTED.

---

BY RALPH D. MERSHON, *Delegate of American Institute of Electrical Engineers.*

---

As transmission voltages, actual or proposed, become higher and higher and transmission distances reach out farther and farther, it is interesting and profitable to inquire into the probable maximum distance to which power will be commercially transmitted. As with most engineering enterprises, the limitations will come through economic conditions, and the greatest distance to which power will ever be transmitted will be the greatest distance through which it can be economically (using the word in its broad sense) transmitted.

In endeavoring to make such forecasts as will be here attempted, it should be borne in mind that every limitation which we put upon ourselves by the assumptions necessary in order to obtain definite representative figures, adds to the chance of our forecast proving erroneous. For instance, the first assumption we must make is that in the future power will be transmitted in the same way as now. This may not hold. There may be devised some other and better way not involving the use of transmission lines. Such, however, does not appear probable. Other assumptions which must be made as to methods of construction being the same as, or similar to, those at present in use, may be eventually so modified by skill and experience as very materially to change any conclusions which may be arrived at now. This is less improbable. Conditions, industrial and financial, may so change that the constants now assumed as fixing costs, interest, etc., will be materially modified. This is very probable. Finally, it is certain that with the course of time the value of power will increase, and this will materially modify any figures at which we may now arrive. The present conditions of practice and possibility are sufficiently definite, however, to warrant a forecast with the expectation that it will be applicable, approximately at least, for some con-



siderable time to come. At any rate, the method of treatment of the subject herein adopted will, with suitable changes in the value of constants, apply so long as present methods of power transmission obtain.

The elements which, in the broadest sense, limit the distance to which power can be economically transmitted, are two—the cost of power at the generating station and the price which can be obtained for the delivered power. The difference between these two elements must cover the cost of transmission, the interest on the investment and the profit. The cost of transmission comprises the loss of power in transmission, the cost of operating, the cost of maintenance and repair. The value of the sum total of the interest which must be paid upon the investment, and the minimum profit which is considered satisfactory, will have much weight in determining the limiting distance of transmission. The less this sum is the farther power can be transmitted; a low interest rate and a low rate of dividend will, therefore, be conducive to long transmissions.

Let us consider in a general way the manner in which the investment in a transmission plant and the annual charges and expenses in connection with the plant vary with different outputs, voltages and distances of transmission. For a given voltage, drop and distance of transmission, the cost of all the apparatus and equipment, except the line conductors, will increase more slowly than the output of the plant. That is, the greater the output of the plant the less the cost per kilowatt of all the equipment, except the line conductors. This will be true of the operating expenses also. Therefore, since the interest charges and the charges for depreciation and repair are dependent upon the investment, the greater the output of the plant the less will be the quantities going to make up the annual cost per kilowatt of transmitting power, except those depending upon the line conductors. Since the weight of the line conductors, under the conditions assumed, will vary directly as the amount of power transmitted, those elements of the annual cost per kilowatt depending upon the line conductors will be practically constant for all amounts of power transmitted, and can not be materially reduced by increasing the amount of power transmitted. With the same voltage, economic drop and output, the elements of annual cost per kilowatt due to the line structure (pole line) and to its extent (patrolling, etc.) will increase directly as the distance. But, as outlined above,

any increase of cost in line structure due to increase in distance can be offset by increase of output. On the other hand, the weight of the line conductors increases as the distance (for the same economic drop—as the square for the same drop) and the elements of annual cost per kilowatt due to the weight of the line conductors will, therefore, increase as the distance, no matter what the output.

It appears, therefore, that all the elements in the annual cost per kilowatt for transmitting power, except those dependent upon the line conductors, may be indefinitely reduced by increasing the amount of power to be transmitted. The annual cost per kilowatt due to the line conductors can not be so reduced. It can be diminished only by such other means as will reduce the first cost of the conductors. As the first cost of the line conductors can be reduced only by increasing the voltage of transmission and as there is a limit to which such increase can be carried, it follows that *the limiting distance to which power can be economically transmitted will depend, finally, upon the cost of the line conductors and upon this alone.* The limit of voltage referred to is not necessarily that due to physical considerations, such as difficulties of construction, air losses between conductors, etc.; for, leaving such matters out of consideration, it is easy to imagine the voltage carried to such a high value as will reduce the line conductors to the point when the increased cost of transformers and insulators, due to a further increase of voltage, will over-balance the saving in the line conductors, due to such further increase.

It will somewhat simplify the treatment of the subject if the interest charge be included as a part of the cost of transmission, and profits be represented by a percentage on the investment. This course will, therefore, be pursued. That is, it will be assumed that in the cost of transmission is included the interest on the investment (bond interest), and that over and above this cost there must be earned a certain percentage, which percentage will represent profits (stock dividends). In addition the following assumptions will be made.

Power purchased at low-tension bus-bars of step-up transformers and sold at outgoing bus-bars of the step-down station.

Frequency of transmission not less than 25 cycles nor more than 30 cycles as being the limiting frequencies which, while favorable to the transmission of power, are yet suitable for almost all purposes to which power can be applied.

Idle synchronous motors at step-down station to correct for power factor, the average power factor of the line being held as near unity as possible. In the plants of large output dealt with below, the possible approximation to unity power factor will, in spite of the line-charging current, be sufficiently close to, for practical purposes, justify the assumption of unity power factor.

That no matter what the capacity of the plant, there will be three transmission lines, each capable of carrying one-third the load.

That the power factor of the load supplied will be 0.8.

That no matter what the size of the plant, the number of transforming units at each end of the line be 18, each transformer being normally worked at five-sixths of its rated capacity, so that one bank of three may be cut out, if need be.

That no matter what the size of the plant, the number of corrective synchronous motors will be six, each being worked at five-sixths of its rated capacity. The kilovolt-ampere capacity of these synchronous motors must, for a load power factor of 0.8, be equal to three-fourths of the kilowatt capacity of the load carried by the plant.

It is evident that the number of units must be considered as the same for plants of all capacities in order to take full advantage of the decrease of cost per kilowatt, due to increase of capacity.

The pole lines will be assumed as constructed with 12 steel towers to the mile.

Ideal conditions will be assumed throughout consistent with delivering reliable and cheap power. Since the object is to determine the *maximum* distance, the factors fixing commercial costs of apparatus will be taken at the lowest values likely to obtain.

Later on in this paper general equations are derived expressing the relations between the distance of transmission and the quantities which govern it. By making assumptions, in addition to those mentioned above, as to the values of the various co-efficients in the general equations and as to the purchase and selling price of power, the curves of Figs. 1, 2, 3, 4 and 5 have been obtained, which are given and discussed here instead of at the end of the paper. Fig. 1 shows the relation between the distance of transmission  $D$  and the economical voltage  $E$  for different outputs  $W$ ; that is, it shows the voltage which it is most economical to use for any given output and distance of transmission. Fig. 2 shows, in a corresponding manner, the economical drop. Fig. 3 shows the diameter of the conductors corresponding to the conditions of

Figs. 1 and 2. Fig. 4 shows the relation between  $D$ , the distance of transmission, and  $p$ , the percentage net profit on the investment for different values of output  $W$  and for the selling price of \$34 per kilowatt per annum. Fig. 5, a curve obtained from Fig. 4, shows the relation between the distance of transmission and the output for a net profit of 12 per cent.

In obtaining these curves, the constants have all been given values

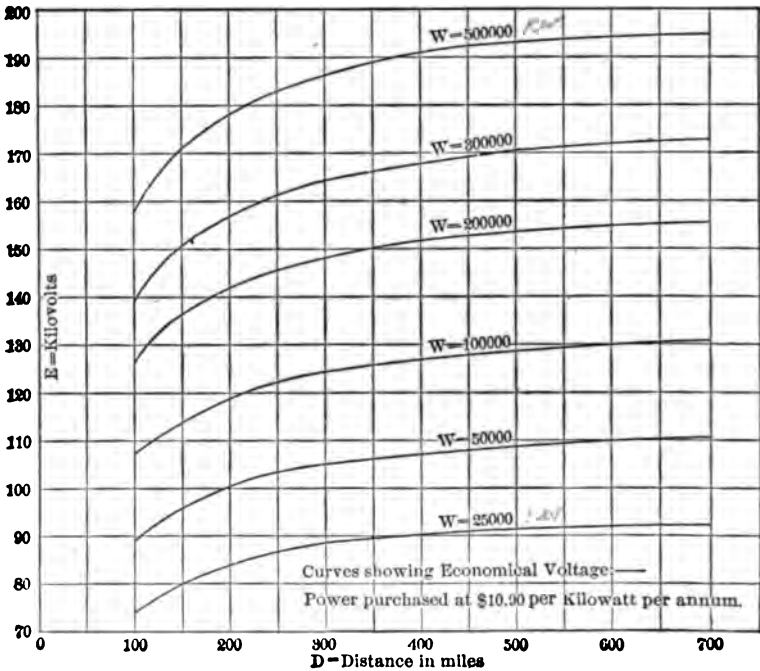

FIG. 1.

favorable to long transmission distances. The costs have been taken lower than those ordinarily current in the endeavor somewhat to anticipate possible future prices. Also, the cost of power purchased at the step-up station has been fixed at the very low figure of \$10.90 per kilowatt per annum. These facts should be carefully borne in mind in considering the curves, which will all be more or less modified by changes in the quantities mentioned.

It is difficult to fix upon a figure for the selling price of the delivered power which shall be representative. Power prices are so dependent upon conditions, especially those arising from the

location and magnitude of the market and of the supply, that any figure chosen will be objected to by some as too high and by others as too low. The same condition applies to the price assumed as that paid for power at the step-up station, but in a lesser degree. The figure herein assumed as the price of the power sold, \$34 per

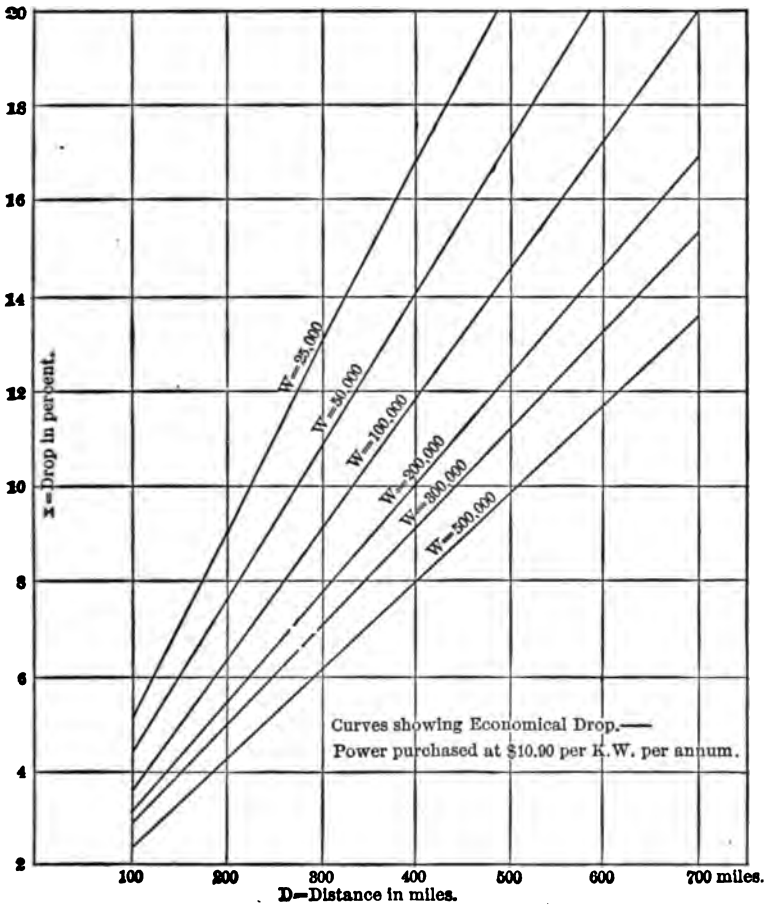

FIG. 2.

kilowatt per annum, is that which seems to the writer will be fairly representative, especially in the case of the large blocks of power. The writer does not, however, wish to be understood as committed to an opinion by the power prices herein, either in the case of pur-

chase or sale. The values taken have been chosen as being as nearly representative as possible of the best conditions which might obtain, favorable to long-distance transmission. If these figures should be criticized in about equal proportion from the standpoints

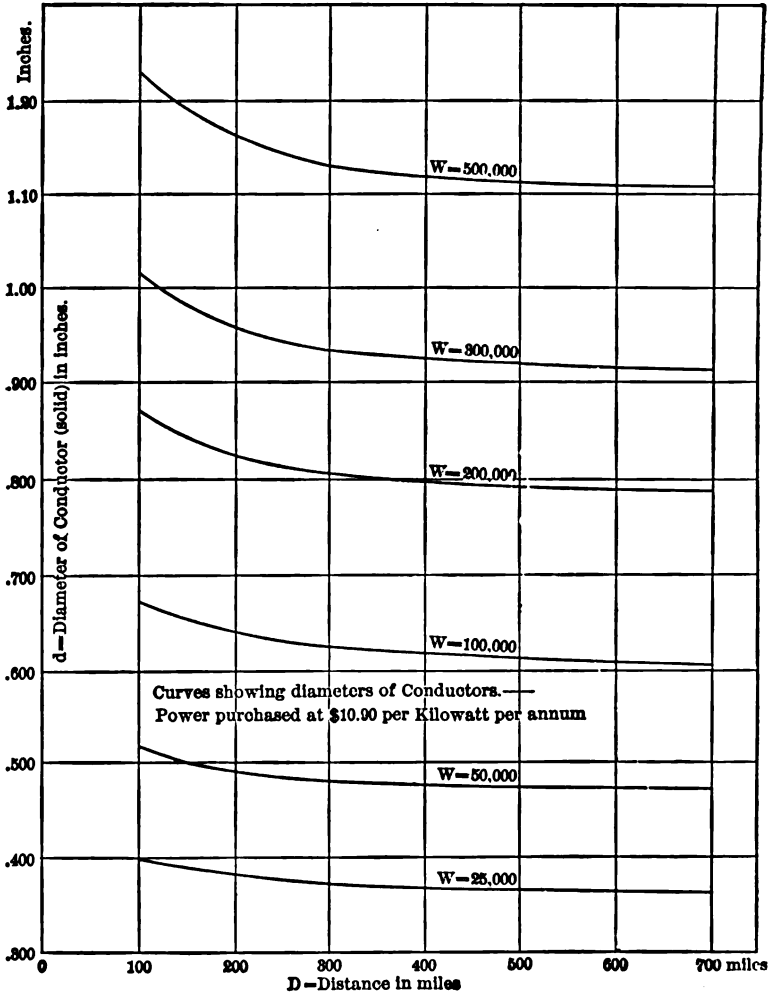

FIG. 3.

of being too low and too high, respectively, the object in choosing them will have been accomplished, since such criticism will be evidence of their fairness as a reasonable compromise.

The maximum amount of power dealt with herein, 500,000 kilowatts, is probably too high to be seriously considered at this time, but from 200,000 to 300,000 kilowatts is believed to be within the range of immediate future possibility. In a plant of this size it

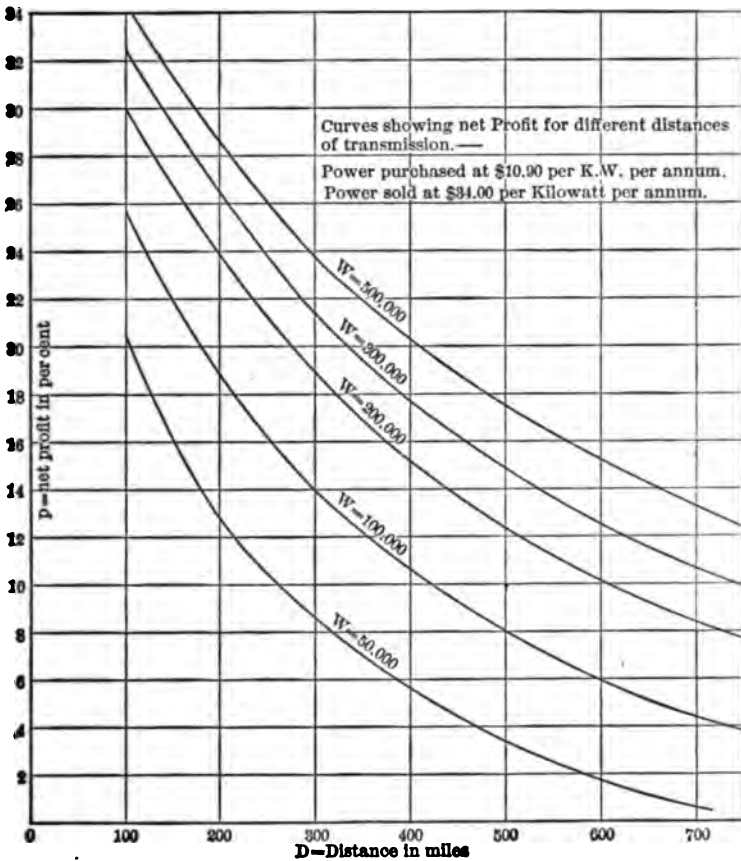

FIG. 4.

is probable that a net return of 12 per cent would be required, not alone for the purpose of dividends, but also as a protection to the bonds. Under these conditions Fig. 5 shows the distance of transmission to vary from 512 miles for 200,000 kilowatts to 623 miles for 300,000 kilowatts.

It appears from the preceding matter that, under the conditions assumed, the limiting distance of transmission will, for some time at least, be in the neighborhood of 550 miles.

It also appears that voltage limits will be fixed by economic conditions and not by conditions depending upon atmospheric losses.

\* \* \* \* \*

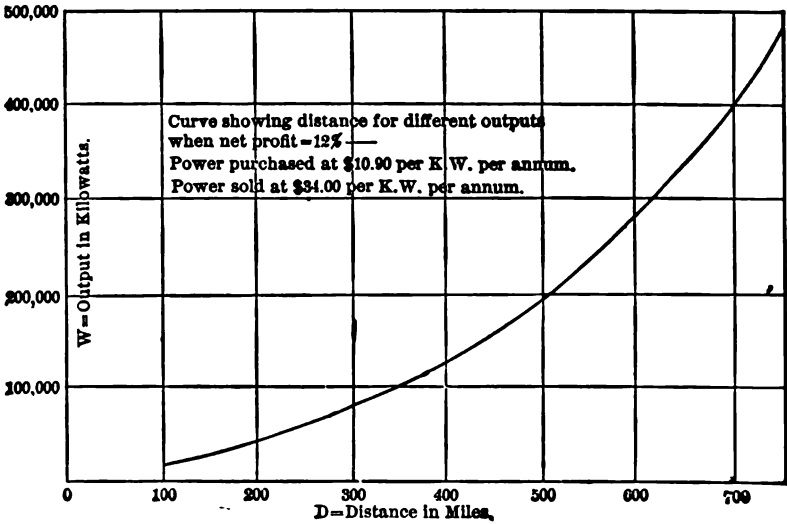

FIG. 5.

The analysis on which depends the general equations from which the preceding curves were obtained will now be taken up.

Let  $E$  = voltage in kilovolts delivered to step-down transformers.

$D$  = distance of transmission in miles.

$x$  = percentage of delivered power lost in the line.

$e$  = efficiency of the whole system.

$e_1$  = combined efficiency of step-up and step-down transformers and synchronous motors.

$d$  = diameter of line conductors in inches.

$W$  = power, in kilowatts, delivered at the low-voltage bus-bars of step-down station.

$c$  = cost, in dollars, per kilowatt per annum at the low-voltage bus-bars of the step-up transformers, of purchased power.



$s$  = price, in dollars, received for power per kilowatt per annum at the low-voltage bus-bars of the step-down station.

$k$  = a quantity which multiplied into  $c$  will give the cost of power at the high-voltage terminals of step-up transformers.

$R$  = total interest, maintenance and depreciation charge per annum.

$L$  = cost of labor for operating transformer stations and for executive and clerical services.

$M$  = total investment.

$C$  = total cost per annum of power delivered, inclusive of interest.

$p$  = a percentage covering profit.

$e = \frac{e_1}{1+x}$  since  $\frac{1}{1+x}$  is the efficiency of the line.

$\frac{Wc}{e} = \frac{Wc(1+x)}{e_1}$  = total amount expended per annum for power purchased.

$W_s$  = total amount received per annum for power sold.

$$C = \frac{Wc}{e} + L + R$$

$$p = \frac{W_s - C}{M} = \frac{W_s - \frac{Wc}{e} - L - R}{M} = \frac{W_s - \frac{Wc(1+x)}{e_1} - L - R}{M} = \frac{N}{M} \quad (1).$$

Now  $M$  is made up of

- 1). Cost of transformers.
- 2). Cost of transformer switchboard apparatus; cables, lightning protection, etc.
- 3). Cost of building and real estate.
- 4). Cost of insulators.
- 5). Cost of pole-line material and construction.
- 6). Cost of right of way.
- 7). Cost of corrective synchronous motors and exciters.
- 8). Cost of switchboard apparatus, cables, etc., for synchronous motors.
- 9). Cost of conductors.

Cost of transformers will depend upon voltage and output;

$f_1(E, W)$ .

Cost of transformer cables and controlling apparatus will depend upon same quantities as transformers, but in a different way;

$$f_2 (E, W).$$

Cost of building will depend upon output;

$$f_3 (W).$$

Cost of insulators will depend upon voltage, diameter of conductors and number required, i. e., voltage, diameter of conductor and distance of transmission;

$$f_4 (E, d, D).$$

Cost of pole-line construction will depend upon diameter of the conductors and the distance. But the diameter of the conductors depends upon voltage, drop, output and distance, hence

$$f_5 (d, D) = f_5 (E, W, x, D).$$

Cost of right of way will depend upon distance only;

$$f_6 (D).$$

Cost of synchronous motors will depend upon output only, since all other factors of cost will be fixed;

$$f_7 (W).$$

Cost of switchboards and cables for synchronous motor will depend upon output only;

$$f_8 (W).$$

Cost of line conductors will depend upon voltage, output, line loss allowed and distance of transmission;

$$f_9 (E, W, x, D).$$

The sum of these nine functions constitutes  $M$ , the total investment.

Now  $R$  (total interest and depreciation charge) depends upon all of the several quantities making up  $M$ .

In what follows, the numerical value of the constants are those taken for the specific problem treated herein.

Let  $p_1 = .125 =$  percentage of transformer cost for interest, depreciation and repairs.

$p_2 = .125 =$  percentage transformer switchboards cost for interest, depreciation and repairs.

$p_3 = .075 =$  percentage of buildings cost, for interest, depreciation and repairs.

$p_4 = .10 =$  percentage of insulators cost, for interest, depreciation and repairs.

$p_5 = .125 =$  percentage of pole line cost, for interest, depreciation and repairs.

$p_6 = .05$  = percentage of cost of right of way, for interest only.

$p_7 = .125$  = percentage of synchronous motor cost, for interest, depreciation and repairs.

$p_8 = .125$  = percentage of cost of synchronous motor, switch-board, etc., for interest, depreciation and repairs.

$p_9 = .05$  = percentage of cost of conductors, for interest, depreciation and repairs.

$R$  = the sum of these percentages multiplied respectively into the several quantities to which they refer.

$L$  depends only upon output,  $f_{10}$  ( $W$ ).

The numerical values given for the percentages  $p_1, p_2, \text{etc.}$ , are those which will be used in the specific problem herein treated. The rate of interest has in all cases been taken as .05, so that by subtracting this from the above values the depreciation assumed in each case may be determined.

If there be substituted in equation (1) the values of  $M, L$  and  $R$ , as expressed by the above symbols, there will result an equation expressing in the most general terms the relations between the distance of transmission and the quantities which govern it. This substitution results in rather an unwieldy expression and will be omitted.

Before proceeding with the determination of the forms of the several functions indicated, it will be necessary to enter into a discussion of the relations existing between voltage and line loss, and the quantities governing them respectively.

Let  $q$  = that portion of the cost per kilowatt at the low-tension bus-bars of the step-down station, which is due to line loss and to interest on the value of the conductors; then, anticipating in part, the matter of a few pages further on

$$q = \frac{\frac{p_9 K_9 W D^2}{E^2 x} - hc Wx}{W}$$

in which  $\frac{p_9 K_9 W D^2}{E^2 x}$  is the interest on the conductors and  $hc Wx$  the cost of the power lost in the line.

Setting the first derivative of this with respect to  $x$  equal to

zero, in order to determine the minimum value of  $q$ , we find the well-known expression for economic drop

$$X = \left( \frac{p_0 K_0}{hc} \right)^{1/2} \frac{D}{E} = n \frac{D}{E} = 0.038 \frac{D}{E} \quad (2)$$

From this equation for  $x$  we may obtain the equation

$$\frac{p_0 K_0 D_0}{E^2 x} = hc x$$

But the first member of this equation is the interest on the line conductors per kilowatt delivered, and the second member is the annual cost of the line loss per kilowatt delivered. That is, for most economical conditions the line loss per kilowatt delivered must be equal in value to the interest on the conductors per kilowatt delivered — a relation also well known.

As has already been suggested, there will be a limit to which the voltage can be carried, due to the fact that although increase of voltage will diminish the annual cost of lost power and of conductors, it will increase the annual cost of certain other important factors. The elements of annual cost which are affected by change of voltage are the interest and depreciation of the transformers, the interest on the line conductors, the line loss and the interest and depreciation of the insulators. The first and last items will increase with the voltage because of the increased first cost due to the increase of voltage; the other two will diminish.

Let  $q_1$  = that portion of the annual cost per kilowatt of delivered power due to the line loss, conductors, insulators and transformers. It has just been shown that for best economy the line loss and annual conductor cost must be equal, so that twice the line loss,  $2 hc W x$ , may be taken as representing the sum of the annual cost due to line loss and to the conductors. As will be shown later, the cost of the insulators will vary as the distance, and as the cube of the voltage and the cost of the transformers may be represented by

$$K_1' (E + K_1'') W^{1/2}$$

Hence remembering that  $p_1$  and  $p_4$  are the interest and depreciation on transformers and insulators, respectively,

$$q_1 = \frac{2 hc W x + p_4 K_4 E^3 (1+x)^3 D + p_1 K_1' (E + K_1'') W^{1/2}}{W}$$

or putting in the value of  $x = \left( \frac{p_0 K_0}{hc} \right)^{1/2} \frac{D}{E} = n \frac{D}{E}$

$$q_1 = \frac{2 hcn WDE^{-1} + p_4 K_4 E^3 (1+n D E^{-1})^3 D + p_1 K_1' (E+K_1'') W^{1/2}}{W}$$

Now, if the first derivative of  $q_1$  with respect to  $E$  be set equal to zero to determine the best value of  $E$ , there results a quartic equation more interesting than valuable, so far as the present purpose is concerned. It will greatly simplify matters if instead of substituting the value of  $x$  in  $(1+x)^3$  we substitute for  $x$  a fixed drop ( $x_1$ ) of such value as will correspond to the average cost of insulator between the two extreme values of  $x$  which will be met with in practice; as will be shown later, the error due to such course will be small. Hence,

$$q_1 = \frac{2 hcn WDE^{-1} + p_4 K_4 E^3 (1+x_1)^3 D + p_1 K_1' (E+K_1'') W^{1/2}}{W}$$

Setting the first derivative of this equation equal to zero, solving for  $E$  and substituting for  $n$  the value,  $n = \left(\frac{p_2 K_2}{hc}\right)^{1/2}$ , there results

$$E = \left( \frac{-p_1 K_1' W^{1/2}}{6p_4 K_4 (1+x_1)^3 D} + \sqrt{\frac{p_1^2 K_1'^2 W}{36 p_4^2 K_4^2 (1+x_1)^6 D^2} + \frac{2(hcp_2 K_2)^{1/2} W}{3 p_4 K_4 (1+x_1)^3}} \right)^{1/2}$$

$$= \left( -3,066 \frac{W^{1/2}}{D} + \sqrt{9,400,356 \frac{W}{D^2} + 3,438.5 W} \right)^{1/2} \quad (3)$$

This shows that the voltage may be increased with increase of output. This was to be expected, since for a given cost of insulators the cost per kilowatt will be diminished as the output increases. The value of  $x_1$  used in the above equation was determined upon as follows:

The minimum drop which is ever likely to obtain is, say, 2.2 per cent, the maximum, say, 11.5 per cent. The reason for selecting these values will be apparent on considering the values of  $E$  calculated from the above equation, and given below, in connection with the values of  $W$  to which they correspond, and the respective distances to which, in each case, the various amounts of power would probably be transmitted. The intermediate value of drop which will give the average insulator cost is 6.45 per cent, and this value of  $x_1$  is taken. With this value of  $x_1$ , maximum error in insulator cost, between the limits assigned, will have place when  $x = 2.2$  per cent and when  $x = 11.5$  per cent. The percentage error at either of these limits is about 13 per cent. But, as appears in the solution of the first derivative of insulator cost, at the

point of minimum of the variables affected by the voltage, the combined values of the annual cost due to the conductors, the annual cost of the line loss, and that portion of the annual transformer cost due to voltage, is more than three times that due to the insulators. The total variable quantity involved, therefore, is more than four times the annual cost due to insulators, and the error, as a percentage of the total of values of the variables involved, is less than  $\frac{1}{4} = 3.25$  per cent, instead of 13 per cent. As will be seen on examining the manner in which  $x_1$  enters the equation for  $E$ , the maximum error in  $E$  will be less than 3 per cent, which also will to a like extent affect the values of  $x$ . These errors are negligible so far as the main problem is concerned, and, indeed, as far as the question of voltage itself is concerned.

In Fig. 1 are shown curves plotted from equation (3). These curves show the kilovolts,  $E$ ; for different distances,  $D$ , and different outputs,  $W$ . Fig. 2 gives curves plotted from equation (2), using the values obtained from the curves of Fig. 1. The curves of Fig. 2 show the percentage drop,  $x$ ; for different distances,  $D$ , and different outputs,  $W$ . In Fig. 3 are curves showing the diameters of the conductors for the conditions of Figs. 1 and 2. These diameters were calculated from the formula

$$d = k_5' \left( \frac{W/D}{E^2 x} \right)^{1/4} = k_5' \left( \frac{WDE}{E^2 n D} \right)^{1/4} = \frac{k_5'}{n^{1/4}} \left( \frac{W}{E'} \right)^{1/4} = .0219 \left( \frac{W}{E'} \right)^{1/4} \quad (4)$$

which gives the diameter  $d$ , in inches, of a solid conductor. These diameters were in this case calculated for a solid conductor instead of a stranded one, because we have at present available data as to the critical point in the atmospheric loss curve for solid conductors only, and while, perhaps, this critical point will come at a higher voltage in the case of the stranded conductor with its greater diameter, there are no definite data at present on the subject. On comparing the diameters of conductors given by Fig. 3 and the voltages to which they correspond with the values of diameters and critical voltage given by Prof. Ryan in his paper on that subject<sup>2</sup> we see that the diameters of Fig. 3 are considerably above those of the paper referred to. It appears, therefore, from the present knowledge available, that the limit of voltage will come through economic conditions, and not through limitations connected with atmospheric losses.

2. See paper read by Prof. Ryan before American Institute of Electrical Engineers, February 26, 1904.

In the determination of both  $x$  and  $E$  the quantity  $h$  has been employed. This quantity is a factor which when multiplied into the cost of power at the low-tension bus-bars of the step-up transformers will give the cost of power at the high-tension terminals of the transformers. That is to say,  $h$  takes account of all charges which should be made against this power, including interest and depreciation of the step-up station, transformers, etc., and labor for operating the station, also the loss in the transformers. Now, strictly, there should be substituted for  $h$  the proper functions of the quantities on which it depends, but to do so would seriously complicate the equations and would be of little utility, since  $h$  can be approximated with sufficient accuracy in any particular case, and the manner in which it occurs in both  $x$  and  $E$  is such as to make the error in the quantities due to an error in  $h$  much smaller than the error in  $h$  itself. In the specific problem herein the value  $c = 10.9$  is taken as being the lowest which will probably ever obtain where large amounts of power are available within transmission distance of a desirable market. The value taken for  $h$  in the determination of  $E$  and  $x$  is 1.1, so that  $hc = 12$ .

The next step is the determination of the forms of the several functions indicated. In what follows, the constants have been evaluated for the specific problem herein. The costs resulting from the use of these constants will be found to be, in general, considerably less than present commercial costs. The constants were purposely based on prices less than can be now obtained in the endeavor to anticipate somewhat possible future prices.

From a careful consideration of transformer prices, it has been determined that for transformers of 1500 kw and over, the cost installed very closely follows the law

$$f_1(E, W) = K_1' (E + K_1'') W^{1/2} = 13. (E + K_1'') W^{1/2}$$

$$\therefore p_1 f_1(E, W) = p_1 K_1' (E + K_1'') W^{1/2} = 1.625. (E + K_1'') W^{1/2}$$

in which  $K_1'$  is a constant and  $K_1''$  a "variable constant," a quantity which varies slowly with the output in accordance with the law

$$K_1'' = k_1 + k_2 W = 55 + 0.000,227 W.$$

Theoretically the transformer cost would vary with the drop  $x_1$  since the step-up transformers would have an output and voltage greater than the step-down transformers. Practically, however, step-up and step-down transformers are built so nearly in the same lines that the drop would make little difference. Such

difference as would exist can be taken care of approximately by adjustment of the constants, which has been done.

While the apparatus for the control of the high-tension side of the transformers would theoretically vary with the voltage, such variation for 50,000 volts and over will be small, since in most modern plants the high-tension switching apparatus is simple and higher voltages are likely to cause it to remain so. The lightning protection for the high-voltage lines might vary with the voltage, but it is probable that for high voltages there will soon be a reversion to much simpler and inexpensive apparatus than we use now, so that the variation, if any, due to higher voltages will be negligible. The switchboard for the lower voltage side of the transformers will vary only with the output, since we assume the lower voltage to be the same in all cases, say 6,000 volts or thereabouts.

The apparatus for the control of transformers may therefore be considered as depending only upon output. Under this assumption a consideration of costs of transformer-controlling apparatus and cables shows that we may assume, with a close degree of accuracy, that

$$f_2(E, W) = K_2' + K_2'' W = 21,000 + 0.9 W$$

$$\therefore p_2 f_2(E, W) = p_2 K_2' + p_2 K_2'' W = 2,625 + 0.1125 W.$$

The cost of buildings and the real estate for them will increase very slowly with the output. The variation of this item, due to variation of output can be closely enough expressed by

$$f_3 W = K_3' + K_3'' W^{\frac{1}{2}} = 125,000 + 125 W^{\frac{1}{2}}.$$

$$\therefore p_3 f_3 W = p_3 K_3' + p_3 K_3'' W^{\frac{1}{2}} = 9,375 + 9.375 W^{\frac{1}{2}}.$$

The cost of an insulator will, theoretically, vary with the diameter of the conductor and the voltage. Practically, however, the diameter of the conductor will have nothing to do with the cost. A consideration of insulator prices shows that the cost of an insulator will vary as the sum of a small constant plus the product of a constant into the cube of the voltage. With high voltages the small constant is negligible, so that we may write

$$f_4(E, d, D) = K_4 E^3 (1 + x_1)^3 D = 0.000,732 (1.0645)^3 E^3 D =$$

$$0.000,883 E^3 D \therefore p_4 f_4(E, d, D) = p_4 K_4 E^3 (1 + x_1)^3 D =$$

$$0.000,088,3 E^3 D.$$

The cost of the pole-line material and construction will depend somewhat upon the diameters of the conductors, since as the diameters of the conductors increase, the wind and sleet stresses will increase. The increase of cost with increase in diameters of con-



ductors will be slow. The law followed will be that of a constant plus a function of the diameters of conductors, since no matter how small the diameters of conductors there will be a certain cost representing the minimum size pole which would be employed. We may, with a fair degree of accuracy, write

$$f_s(d, D) = (K_s' + K_s'' d) D = f_s(E, W, x, D) = K_s' D + K_s'' k_s \left( \frac{WD}{E^2 x} \right)^{\frac{1}{2}} D$$

or putting in the value of  $x = n \frac{D}{E}$

$$f_s(E, W, x, D) = K_s' D + \frac{K_s'' k_s}{n^{\frac{1}{2}}} \left( \frac{W}{E} \right)^{\frac{1}{2}} D = 3,000 D + 37.2 \left( \frac{W}{E} \right)^{\frac{1}{2}} D$$

$$\therefore p_s f_s(E, W, x, D) = p_s K_s' D + \frac{p_s K_s'' k_s}{n^{\frac{1}{2}}} \left( \frac{W}{E} \right)^{\frac{1}{2}} D = 375 D + 4.65 \left( \frac{W}{E} \right)^{\frac{1}{2}} D$$

which answers for a stranded conductor.

Cost of right of way will be directly proportional to distance, hence

$$f_s(D) = K_s D = 1000 D.$$

$$\therefore p_s f_s(D) = p_s K_s D = 50 D.$$

A consideration of synchronous motor prices shows that the cost of synchronous motors may be written

$$f_7(W) = K_7' + K_7'' W = 12,000 + 32.4 W.$$

$$\therefore p_7 f_7(W) = p_7 K_7' + p_7 K_7'' W = 1,500 + 4.05 W.$$

The switchboards and cables for the motors will follow the same law as those for the transformers, hence

$$f_8(W) = K_8' + K_8'' W = 8,400 + 0.17 W.$$

$$\therefore p_8 f_8(W) = p_8 K_8' + p_8 K_8'' W = 1,050 + 0.021,25 W.$$

From the well-known relations between the cost of conductors and the voltage, distance, output and drop, we may write

$$f_9(E, W, x, D) = K_9 \frac{W I^2}{E^2 x} = 0.346 \frac{W I^2}{E^2 x}$$

or putting in the value of  $x = n \frac{D}{E}$

$$f_9(E, W, x, D) = K_9 \frac{W D}{E n} = \frac{K_9}{n} \frac{W D}{E} = 9.1 \frac{W D}{E}$$

$$\therefore p_9 f_9(E, W, x, D) = p_9 \frac{K_9}{n} \frac{W D}{E} = 0.455 \frac{W D}{E}$$

The cost of labor for the operation of the step-up and step-down transformer stations and for executive and clerical purposes would probably not vary at all. We have in each case the same number of units to be looked after and the size of these units would make little, if any, difference in the cost of attendance upon them. Similarly, the output will make little difference in executive and clerical costs. We would probably be justified in making  $f_{10}(W)$  a constant. In order, however, to cover such small increase in labor and salaries as there might be with increase of output we will write

$$f_{10}(W) = K_{10}' + K_{10}'' W^{1/2} = 32,000 + 26 W^{1/2}.$$

It is to be noted that the labor in connection with the line is taken care of in the depreciation and repair percentages applicable to the supporting structure and insulators respectively.

The efficiency of the whole system is  $\frac{e_1}{1+x}$  (see page 261).

Putting in the value of  $x = n \frac{D}{E}$

$$e = \frac{e_1}{1 + n \frac{D}{E}} = \frac{0.925}{1 + 0.038 \frac{D}{E}}$$

$$\frac{Wc}{e} = \frac{W \left(1 + n \frac{D}{E}\right) c}{e_1} = \frac{Wc}{e_1} + \frac{nc}{e_1} \frac{WD}{E} = 11.78 W + 0.448 \frac{WD}{E}.$$

The various functions above arrived at may now be utilized in obtaining  $N$  and  $M$  of equation (1)  $p = \frac{N}{M}$ .

Remembering that  $R$  is the sum of the products of the various functions by the corresponding percentages representing interest, depreciation and repair; that  $L = f_{10}(W)$ ; and representing the various resulting collections of constant as follows:

$$a = p_2 K_2'' + p_7 K_7'' + p_8 K_8'' = 4.184.$$

$$b = K_{10}' + p_2 K_2' + p_3 K_3' + p_7 K_7' + p_8 K_8' = 46,550.$$

$$m = K_{10}'' + p_3 K_3'' = 35.38.$$

$$r = p_5 K_5'' + p_6 K_6 = 425.$$

$$\text{then } N = Ws - \frac{Wc(1+x)}{e_1} - L - R =$$

$$\left(s - \frac{c}{e_1} - a\right) W - \left(\frac{nc}{e_1} + \frac{p_3 K_3'}{n}\right) \frac{WD}{E} - m W^{1/2} - p_1 K_1' (E + K_1'') W^{1/2} \\ - p_4 K_4 (1+x)^3 E^3 D - rD - \frac{p_5 K_5'' k_5}{n^{1/2}} \left(\frac{WD}{E}\right) D - b$$

Representing constants as follows:

$$\begin{aligned} \alpha &= K_2'' + K_7'' + K_8'' = 33.47. \\ \beta &= K_2' + K_3' + K_7' + K_8' = 166,400. \\ \gamma &= K_5' + K_6 = 4,000. \end{aligned}$$

Then

$$\begin{aligned} M = \alpha W + \frac{K_9 WD}{n E} + K_3'' W^{1/2} + K_1' (E + K_1'') W^{3/4} + K_4 (1+x_1)^3 E^3 D \\ + \gamma D + \frac{K_5'' k_5}{n^{3/4}} \left(\frac{W}{E}\right)^{3/4} D + \beta. \end{aligned}$$

These values of  $N$  and  $M$ , if substituted in equation (1), will give in its final form the equation connecting distance, output, voltage and profit; or in connection with equation (3) for voltage, the relation between distance, output and profit. Such substitution results in a cumbersome equation, and will not be here written. If the various numerical values already determined for the specific problem herein treated be substituted in  $N$  and  $M$  there results

$$\begin{aligned} N = (s - 15.96) W - 0.903 \frac{WD}{E} - 35.38 W^{1/2} - 1.625 (E + K_1'') W^{3/4} \\ - 0.000,088,3 E^3 D - 425 D - 4.65 \left(\frac{W}{E}\right)^{3/4} D - 46,550. \end{aligned}$$

$$\begin{aligned} M = 33.47 W + 9.1 \frac{WD}{E} + 125 W^{1/2} + 13 (E + K_1'') W^{3/4} + 0.000,883 E^3 D \\ + 4,000 D + 37.2 \left(\frac{W}{E}\right)^{3/4} D + 166,400. \end{aligned}$$

The value of  $s$  in the above equation for  $N$  will be taken as 34; that is, it will be assumed, for the purposes of the specific problem, that power is sold at \$34 per kw year. Putting in this value of  $s$  and calculating the value of  $p$  for different outputs,  $W$ , and different distances,  $D$ , the curves of Fig. 4 have been obtained. These curves show for different values of  $W$  the relation between  $p$  and  $D$ .

In considering these curves the assumption made in connection with them should be carefully borne in mind. A small change in the purchase price or selling price of power will make a great difference in the result. Smaller amounts of power will in general be purchased at a higher price per kilowatt, but on the other hand they would probably be transmitted to points where the power would bring a higher price, since, in general, the larger the market the cheaper can power be produced by steam.

It would be interesting to let  $s - c/e_1$  equal to zero and determine

$p$ , which would then be the cost, including interest, of operating the plant. If curves showing the percentage of the investment for operation were determined, also the total cost of the plant, both for different outputs, the results would be valuable in preliminary estimates. The writer hopes to work up such data at a later date.

It will be noticed on referring to the curves that some of them reach to distances which cause the drop to exceed the value taken for the upper limit of drop in connection with insulator cost. The error due to 1 or 2 per cent excess will not greatly affect the final result. It would have been somewhat better, however, for the specific problem treated to have chosen the limits of drop as 5 per cent and 15 per cent respectively instead of those taken.

# SOME ELEMENTS IN THE DESIGN OF HIGH-PRESSURE INSULATION.

BY PROF. HARRIS J. RYAN, *Cornell University.*

Design in any line of practice involves the application of a properly trained judgment. This trained judgment can only be acquired through the enthusiasm of the specialist and as the result of a large practical experience based upon a knowledge of the corresponding science. The object of this paper is not to deal comprehensively with the subject. It is the purpose of the writer to present only those elements of modern electrical science upon which must rest the trained judgment of the designer of high-pressure insulation.

The duty of predominating importance in high-pressure insulation is to withstand electrical strains. The requisite dielectric strength in low-pressure electrical apparatus is easily attained. The difficulties in low-pressure insulation design that must be overcome are to be found in the mechanical requirements and the deteriorating influences of dust, temperature changes, moisture, etc. The judgment of the designer of low-pressure insulation is assisted only to a small extent by electrical science. Success depends mostly upon experience in regard to mechanical, factory and experimental knowledge of the various materials and expedients available for this class of insulation. On the contrary, in apparatus employing the higher electrical pressures in commercial use, great difficulty is encountered in the provision of insulation that has ample dielectric strength to withstand continuously the electric strains that are encountered. For these reasons the following methods and data are useful in the design of insulators to withstand high electric pressures:

1. A convenient system for fixing quantitatively the flux of electric force produced by an e.m.f. in a dielectric, causing the electric strain therein.
2. The permeability of an insulation to flux of electric force produced by e.m.f.

3. The density of flux of electric force which the ultimate electric strength of the insulation is called upon to withstand and at which rupture occurs.

4. Expedients that localize the application of the electric strain within those portions of an insulating system that are most powerful and capable of standing the total strain.

5. Experimental methods for testing the dielectric materials:

a. For the construction of insulation so as to secure their breaking strains, that is, the densities of electric force flux at which their ultimate rupturing strengths are developed.

b. For testing completed insulations or insulators to determine: 1.) The manner in which they satisfy the requirements. 2.) To determine design factors.

6. Factors of safety.<sup>1</sup>

These topics will be treated in the order given above.

### 1. FLUX DUE TO E.M.F.

In order to make note of a convenient system for fixing quantitatively the flux of electric force produced by an e.m.f. in a dielectric causing therein electric strain, it will be necessary first to consider:

#### *The Behavior of a Dielectric when Subjected to Electric Strain.*

When the terminal faces of a dielectric are in contact with conductors between which an e.m.f. is applied, an electric force is exerted throughout the dielectric in variable degree, according to position with reference to the conductors. This electric force produces a distortion of the atomic structure of the dielectric; i. e., a displacement of the electrons forming the dielectric atoms. Such electron-displacement, while in progress, constitutes an electric current. The displacement encounters the reaction due to internal atomic forces which tend to maintain the original structural form. This reaction is the cause of the formation of the familiar counter e.m.f. of a condenser and is in proportion to the total amount of electricity or the time-integral of the current that was passed through the dielectric. When the process of atomic distortion proceeds beyond the point of structural rupture, the ordinary conduc-

1. Determined by trained judgment.

tion current ensues. Thus through a dielectric prior to the rupturing point the only current that can be passed is a *displacement current*.<sup>2</sup> The passage of such displacement current and the establishment of the corresponding field of electrostatic force are merely cause and effect in one and the same operation. In any portion of the dielectric the value of the strength of the electrostatic field of force therein established is proportional to the displacement of electricity, i. e., to the time integral of the displacement current that accompanied the establishment of such electrostatic field.

*"For engineering purposes, therefore, the time-integral of displacement current<sup>3</sup> may be conveniently employed as a measure of the strength of the corresponding electrostatic field of force."*<sup>4</sup>

For convenience, *strength of electrostatic field of force or density of flux of electric force* will be referred to as the *density of dielectric flux*.

## 2. INSULATION PERMEABILITY.

A convenient designation of the permeability of an insulation for dielectric flux is based upon the above facts as follows:

The specific inductive capacity of a dielectric is the ratio of the displacement current set up through such dielectric to that set up through air under the same conditions with respect to the electrodes and the e.m.f. Thus when the displacement current for a unit volume of air subjected to a strain of unit e.m.f. is known, the corresponding displacement current becomes known for any dielectric for which the specific inductive capacity is known.

"The energy that is taken up in the formation of an electrostatic field of force through a dielectric and which has been applied, therefore, in the passage of the corresponding time-integral of displacement current, is

$$J = 1/2 C E^2 \quad (1)$$

where  $C$  is the capacity in farads; i. e., the coulombs of displacement current per volt.

2. An exception must be made in regard to the tiny current that will pass conductively through all dielectrics, gases, liquids or solids when subjected to electromotive forces, generally understood to be carried by the free electrons that reside to a small extent in all dielectrics. These currents are so small for gases and the powerful solid and liquid dielectrics when homogeneous and free of all conducting matter, that for engineering purposes they may be entirely neglected.

3. In engineering this is called the *charging current*.

4. "The Conductivity of the Atmosphere at High Voltages," by H. J. Ryan. *Trans., A. I. E. E.*, Vol. XXI, p. 280, 1904.

When an e.m.f. of *one volt* is applied to the opposite faces of a centimeter-cube of air at ordinary barometric pressure and temperature, the energy taken up by the electrostatic field formed thereby throughout the cube will be

$$441.7 \times 10^{-10} \text{ joules.}$$

No important change in this value occurs with variation of barometric pressure and temperature. When it is substituted in equation (1) the corresponding strength of electrostatic field thus produced per volt per centimeter of air expressed in coulombs of displacement current per square centimeter is found to be

$$C = 883.4 \times 10^{-10} \quad (2)$$

It may, therefore, be stated with reference to the dielectric permeability of air that:

*"One volt applied through a distance of one centimeter in air will establish a dielectric flux density of  $883.4 \times 10^{-10}$  coulombs per square centimeter."*<sup>5</sup>

Thus the product of this dielectric flux constant for air and the specific inductive capacity of an insulation will be the corresponding dielectric flux constant for that insulation.

Where the specific inductive capacity of an insulation is not known, it can be determined in the following manner:

The sample of insulation should be formed into a sheet of uniform thickness. Suitable disc electrodes are applied to either side of the test sheet. The charging current is measured which is made to pass between the electrodes through the test sample by an alternating e.m.f. of known wave form and value. To avoid the error due to the fringe of dielectric flux at the edge of the electrode, a guard ring should be employed similar to that used in an absolute electrometer. Care must be taken to connect such guard ring to the circuit in such a manner that it will not accept charging current through the current-measuring instrument. From the dimensions of the test sample and the guarded electrodes, the values of the current, e.m.f. and the time, *the coulombs of charging current per volt per unit cube are easily deduced.*

*Since a certain amount of electric strain in a given insulation is due always to the passage through it of a certain quantity of elec-*

5. "The conductivity of the Atmosphere at High Voltages," by H. J. Ryan. *Trans. A. I. E. E.*, Vol. XXI, p. 281, 1904.



*tricity per unit cross-section*, it follows that the permeability constant derived as above will enable one to predetermine the strains that are produced by the application of a given amount of electric pressure when the forms of insulation are simple. This is a means whereby the judgment may be greatly assisted or improved in designing insulations where the dimensions are too complex, as is generally the case, to admit of exact calculation of the electric strain.

It may be well to call attention to the relation between the electrostatic capacity that exists between any pair of electrodes and the dielectric flux that an e.m.f. applied between them will establish. The capacity is equal to the coulombs of charging current per volt applied between the electrodes and is, therefore, numerically equal to the dielectric flux established per volt applied between such electrodes. Where the dimensions of the electrodes and dielectrics are simple enough to admit of handling them mathematically, dielectric flux densities, i. e., electric strains may, therefore, be easily calculated from the value of the capacity; and *vice versa*, the capacity may be calculated from the dielectric-flux constants.

### 3. DISRUPTIVE FLUX.

The dielectric flux density at which the resulting electric strain becomes sufficient to produce structural rupture for a given insulation under definite conditions as to temperature and mechanical pressure must be observed by experiment. In making break-down tests of this character some care must be taken in arranging the test sample so that the distribution of dielectric flux is uniform throughout the portion of the sample in which the rupture is made to take place. This is a condition in the present state of the technology that is rather difficult to obtain. It is highly desirable that the dielectric medium in which the test sample and electrodes are immersed should be dielectrically more powerful than the sample under test. It is difficult to make a reliable break-down test of a powerful solid dielectric in the ordinary atmosphere. This is due to the fact that the ultimate breaking strength of the normal atmosphere is small compared with the breaking strength of the test sample.

When the test is conducted in the normal atmosphere, it is impossible to subject the sample to strain without at the same time straining the air about it or in contact with it. Unless great care

is used in arranging the test sample the air will break, conduct and heat injuriously the sample when subjected to strains that are much lower than the strains at which such sample will be found to break if tested in a manner so as not to be injured by the intense heat of the conducting atmosphere.<sup>6</sup> This is quickly demonstrated by making a break-down test of sheet hard rubber mounted between the test electrodes first in the normal atmosphere and then in air, for example at a mechanical pressure of 20 atmospheres. The dielectric strength of air in the latter case is quite on a par with that of the hard rubber which will then rupture because of the electric strain and not because of injury by heat.

There is much to do in this branch of electrotechnics in the development of convenient and satisfactory methods for testing insulations to determine the actual dielectric flux densities or electric strains that produce rupture.

#### 4. INSULATION EXPEDIENTS.

Every portion of a high-pressure circuit is covered with insulation that is permeated everywhere by dielectric flux causing corresponding strain. The quantitative nature and distribution of this flux is entirely similar to the corresponding features of magnetic flux and should, therefore, be easily understood. Dielectric flux is established as tubes of electric force through the insulation between the conductor surfaces in proportion to their corresponding differences of electric pressure.

Thus it is evident that the greatest dielectric flux densities must occur in those zones of insulation that are next to the conductors of the electric circuit. This must be so since the total flux through any outer zone surrounding the circuit must be the same as that through the zone next to the circuit. Since the sectional area determined by the latter zone must inevitably be smaller than the sections at corresponding outer zones, it follows that the density of the dielectric flux will be greatest in the zone-sections next to the high-pressure conductors. This fact would indicate that in rational design the insulation next to the conductor surfaces of high-pressure circuits should be formed of the most powerful dielectrics. Unfortunately, structural requirements generally make this impracticable.

6. It is assumed that all test pressures are alternating.

For example, in Fig. 1, there is given a section of an armature slot containing two coils of a high-pressure alternator, 10,000 to 15,000-volt class. The conductor from which these coils are made is given an insulation covering that is fully capable of withstanding the electric strains due to e.m.f.'s. produced or consumed locally in that particular section of the armature circuit. This may be called the *minor insulation*. It is determined in the main, as are all low-potential insulations, so as to meet structural and mechanical requirements without undue expense. Over the coil as a whole there is applied a carefully constructed covering made of the most powerful available dielectric having an ample strength to withstand continuously in practice the strains due to the total e.m.f.'s. generated in, or applied to, the circuit of this armature. This outer covering may be called the *major insulation*. While this represents the best



FIG. 1.

practice that has as yet been attained, it contains one element of serious weakness as follows:

The dielectric flux starts from the surface of the outer conductors and traverses the minor and major insulations in series and stops at the surfaces of the slot. Note the relative values of the densities of dielectric flux passing the two concentric zones in the insulation about the coil; the inner zone is located by the irregular outer surface of the conductors of the coil and the outer zone by the regular walls of the slot. The dielectric flux passes from the surfaces of the outer conductors of the coil to the walls of the slot and in so doing traverses these zones. It passes the inner zone at considerable irregularity in density and the outer zone at a much more nearly uniform density. The sectional area determined by the inner zone is considerably less than that determined by outer zone. From these two classes of facts it follows that the maximum dielec-

tric-flux densities to which the insulations are subjected are considerably greater for the minor than for the major insulation. This is decidedly unfortunate; better results would be obtained with the conditions reversed.

Due to these facts it follows that in practice of this class the major insulation, without sacrificing break-down strength and structural character, should have the lowest attainable permeability to electric force, i. e., the highest attainable specific reluctance to dielectric flux. This is needful in order that the total dielectric flux established from the surfaces of the outer conductors of the coil to those of the slot shall be limited so as to be well below the point at which the maximum dielectric flux density encountered in the minor insulation will not be sufficient to cause its rupture.

The minor insulation is invariably porous, containing air or other gases at normal atmospheric pressure. Comparatively low densities of dielectric flux are required, therefore, to rupture minute volumes of the minor insulations, which will then conduct the charging currents, causing rapid deterioration through heating and other physical and chemical effects. The thickness of powerful dielectrics having low specific inductive capacities that must be applied in order to maintain all dielectric-flux densities low enough so as not to injure the minor insulation becomes so great as to be impracticable in the present stage of the industry for machinery construction at higher pressures than 15,000 volts. In all high-pressure apparatus, whether of the machinery or transformer class, the inevitable dielectric flux is established in like amounts serially through the major and minor insulations. Owing to structural difficulties the minor insulation is far inferior in strength to the strength of the best dielectric available for the major insulation. It is on this account that such an enormous amount of dielectric of high reluctance to dielectric flux must be used in the construction of the major insulations of dry or "air-insulated" transformers. The amounts of major insulation that must be used are excessive taken with respect to that which should be ample to withstand in practice the electric strains produced by the normal, or ordinarily abnormal, electric pressures.

It is the experience of reputable makers that the air-insulated transformer is impracticable for pressures higher than about 35,000 volts; space and materials cannot be afforded to limit the dielectric flux sufficiently at higher pressures.

Oil may be used successfully for the generation of the highest pressures desired in practice. By proper treatment in its preparation for use in submerging the high-pressure transformer, and by proper construction of the solid or supporting insulation of the transformer-conducting circuit, all air and other gases may be displaced. The oil and solid insulations thus form a combined or composite major and minor insulation having great dielectric strength at all points.

Even with the most approved use of oil, however, the conditions are not exactly ideal. The dielectric flux emanates with greatest density from the surfaces of the outer conductors of the terminal coils, owing to the fact that the zone-section at this point is the smallest and the density of dielectric-flux distribution the most variable. The result is that the chief electric function of the oil is to limit the dielectric flux to within the point at which the maximum flux density that will emanate from the surface of the conductors of the high-pressure circuit will be safely within that which the composition of oil and fabric next to the conductors will stand. Times will come in practice when the high-pressure circuit of the transformer must stand excessive pressures applied from without or developed within by complex impedance phenomena during short-circuits or open circuits. Thus occasionally and momentarily the insulation next to the conductors will be subjected to strains due to dielectric-flux densities that exceed the breaking point causing a corresponding momentary conduction, heating and injury. Such injuries initially are often very small, yet they are cumulative, for their cause is recurrent and their location is the worst possible.

In this analysis one is led, therefore, to the conclusion that a rational solution of these difficulties applicable alike for "air-insulated" and "oil-insulated" high-pressure apparatus consists in the employment of metallic guards or envelopes closely surrounding the coils or sections of the circuits of such high-pressure apparatus for the purpose of relieving the minor insulation of all electric strain due to normal operation. To relieve it further of those highly localized strains that are due to complex impedance phenomena that accompany short-circuits, opening circuits and similar punishing circumstances, an undue local rise of potential difference in the individual coils may be prevented by the attachment of properly chosen spark arresters to the terminals of such individual coils. The real function of the metallic guard is to form

a conducting envelope about the individual coils of the high-pressure circuit to which to conduct the inevitable charging current and from which the corresponding dielectric flux starts through the major or powerful dielectric at an average lower and more uniform density. The guard must be connected to one terminal of the coil that it protects, and it must be constructed in such a manner as to avoid the circulation of current. Obviously these guards and spark arresters may be applied much more easily in transformers than in machinery. By their use it should be possible to make successful transformers for the use of the highest electric pressures that the transmission lines of the future can successfully carry.

We have seen that it is irrational to expose the minor insulations to the great electric strains which powerful major insulations are alone calculated to stand. So long as the major insulation must be designed for sufficient reluctance to limit the dielectric flux to a value that the minor insulations can safely stand, there is no rational relation between the amount of major insulation required, its ultimate break-down strength and the normal working pressure of the high-potential circuit. When, however, the electric strain is carried past the minor insulation and applied properly only to the major insulation, there appears at once a rational relation between the normal working pressure and the ultimate pressure required to rupture such major insulation.

##### 5. TEST OF INSULATING MATERIAL.

In all classes of tests to be made which are here referred to, measurements must be made that will determine the value and wave forms of the applied e.m.f. and charging current and their phase relation. The maximum value of the electrical pressure wave applied between a conducting cylinder and a wire mounted at its center that produces luminous conductivity observed by the eye in the zone of air next to the wire is definite at definite barometric pressures and temperatures. This promises to be an acceptable method for determining the maximum value of the wave of high pressure applied in this class of testing. The wave forms are most easily observed by means of the cathode ray wave indicator. When they are not too irregular the oscillograph may be used in lieu of the wave indicator.

A satisfactory indicating wattmeter is much needed for the ready detection of conduction due to rupture of gas bubbles or other weak foreign dielectrics in the sample under test. It is useful also for the purpose of measuring the total watts consumed by the charging current at any stage of the test. Any sensitive wattmeter of the dynamometer type and of excellent construction, having a suitably fine field winding, will give correct results, provided the non-inductive resistance used for the pressure circuit be properly protected from the delivery of the inevitable capacity-charging currents. Such charging currents, if allowed to pass to and from the surface of the pressure-circuit resistance, produce errors of an entirely uncertain character for which no satisfactory correction can be made. Since these capacity currents may not be avoided they must be made to pass from guards supplied independently with potentials correspondingly equal to the potentials of the respective sections

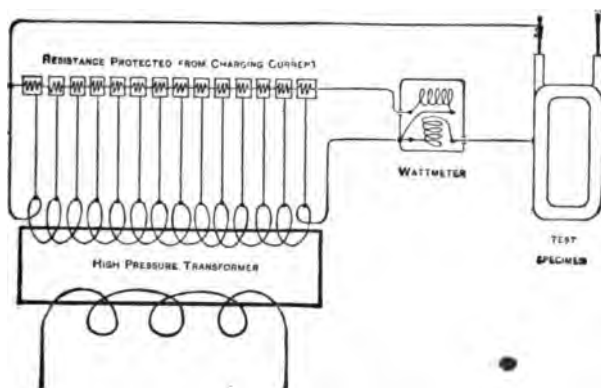

FIG. 2.

of the pressure-circuit resistance about which they are mounted. Two obvious methods for accomplishing this are illustrated by the diagrams which explain themselves in Figs. 2 and 3.

The diagram of Fig. 2 illustrates the method for protecting the resistance of the pressure circuit from capacity-charging currents wherein the transformer furnishing the high-pressure test currents is near at hand. In this transformer the high-pressure circuit is divided into as many sections or coils as there should be guarded sections in the high-pressure resistance circuit of the wattmeter. When this sort of high-pressure transformer is not at hand the method given by the diagram in Fig. 3 may be employed.

Across the terminals of the high-pressure source there are connected in series as many small auto-transformers as there are to be guarded sections in the pressure resistance circuit. Each of these auto-transformers must have a normal e.m.f. rating as great as its share of the total pressure; it should be mounted upon a high-potential line insulator of a form suitable for the total pressure employed. These auto-transformers are connected to corresponding resistance guards as shown, bringing them to the potentials

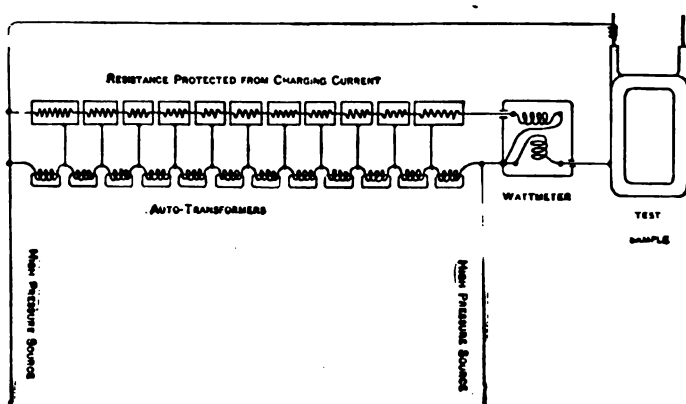

FIG. 3.

corresponding to those of the resistance sections over which they are mounted so as to protect them from the delivery of charging current. As the diagrams of Figs. 2 and 3 show, the wattmeter must be covered with a metallic guard net connected to the proper side of the circuit so as to relieve it also of the delivery of all charging current. A wattmeter mounted and used in this manner must give reliable results in the observation of *pressure-loss characteristics of insulations*.

The nature of such characteristics is illustrated in Fig. 4.

Characteristic No. 1 is that of an insulator which is homogeneous and continuous between the conductors and wherein the strain is distributed with some approach to uniformity.

No. 2 is the pressure-loss characteristic of an insulator wherein there are portions that are weak or the dielectric flux is distributed very irregularly, or both.

No. 3 is a characteristic taken from a composite insulation made up of strong and weak dielectrics as found for example in a paper insulated cable.



In conclusion, the writer wishes to call attention to the fact that these scientific elements that are useful in the production of high-pressure insulations have long been known. What is really little known, however, is the association of ideas necessary to apply them. Attention may properly be called to the fact that a far less proportionate use of mathematics can be made in determining necessary dimensions in the design of insulation than is the case correspondingly for either of the other two components of electrical machinery and apparatus, viz., the circuits accommodating electric current and magnetism.

The great majority of practical problems for solution by calculation that arise in connection with the conducting circuits or the

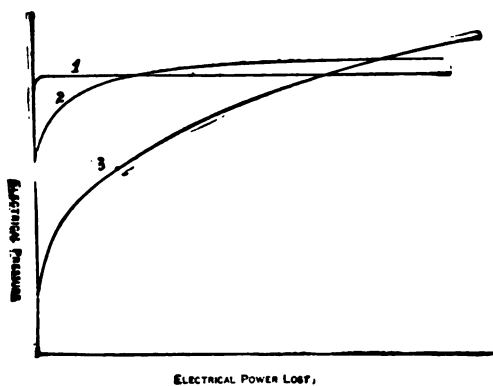

FIG. 4.

magnetic circuits are easily possible because of the definite density distribution of the current or magnetic flux in their respective circuits. From the inherent nature of things the density distribution of dielectric flux through the insulation is definite only in a few forms of electrical apparatus, as for example through the insulating sheets of condensers, except at the edges of their electrode coatings, or throughout the atmosphere about a transmission line. In the great majority of cases the distribution of the dielectric flux is too complex to admit of the reduction of accurate results by the simpler mathematical processes. The judgment supplemented by the results of tests and measurements made upon test samples, specimens or models must, therefore, make up for lack of calculating methods.

## DISCUSSION.

PROF. C. A. ADAMS: The engineering profession owes a great debt to that man who has lifted ever so small an area of engineering method out of the empirical, rule of thumb, hit or miss realm, into the rational, scientific realm. This is what Professor Ryan has done to the large and very important field of high-voltage insulation.

MR. E. KILBURN SCOTT: It has always seemed to me that the greatest trouble we have with insulation is in the smaller sizes of motors and static transformers. For instance, if you wind a motor, say, of 3 hp for 500 volts or higher, the wire becomes quite small, perhaps No. 25 British W. G., and when you insulate so small a wire, the bulk of the space in the slots is occupied by the insulation. A 3-hp carcass, wound for 110 volts, may be well over power; but if wound for 500 volts, the chances are it will run hot, simply because of the extra space required for the insulation. The question is, what are we to do? Well, it has occurred to me, and has been suggested, I believe, by others, that it might be feasible to use other material than copper for the conductors. For example, why should we not use iron, and so reduce the number of our conductors, while at the same time increasing their size, so as to obtain a cross-section which is capable of being handled by workmen? Iron wire, one-sixteenth inch in diameter, would be much more easily handled by the ordinary workmen than No. 25 British W. G. copper wire. It is true that the periphery of the larger wire requires more insulation to go around it, but, inasmuch as the iron would be carrying magnetic lines as well as current, the number of wires for a motor of given output would be considerably reduced, and I think that on the whole the net result would be that the space occupied by the insulation would be less. Perhaps the carcass would be larger, but there is something very attractive in the idea of an all-steel motor.

My ideal of an electric motor of, say, 3 hp for driving machine tools would be one made entirely of steel, cast iron, mica and japan. I would even propose cast iron for the commutator segments; because the commutator for such a motor is very much larger than the conditions of electric conduction demand. However that may be, I do not see why we should not use in the smaller sizes of direct- and alternating-current motors japanned iron wire, and do away with the very unmechanical cotton, paper, and fibrous materials.

CHAIRMAN RUSHMORE: I desire to add a few remarks in the way of appreciation of the work which Professor Ryan has done. Practically all of my experience has been in the manufacture of electrical machines and apparatus, and I know that the question of insulation has long received more or less scientific treatment. Experiment has shown the resisting properties of various insulating materials, but a clear understanding of their action has not been obtained. There is probably no line of research that is being pursued at present with greater interest and with more possibilities than is the subject of insulation. It is at present the limiting feature in electrical development, and especially in the engineering and commercial features of power transmission. Within

the last year, cotton insulation on wires has been in many cases dispensed with, the insulating material being placed directly on the metal conductor.

A point in Professor Ryan's paper which I wish especially to comment upon and which one does not always hear from a man in university work is, that the design of electrical apparatus necessarily involves the application of judgment and experience. In contrast to this was a view taken by a writer not long since, in giving methods of the design of electrical machinery, in which it was remarked that with the information given anyone could design electric generators without experience.

Quite recently an expert on the subject of insulation was discussing the question as to whether or not dielectric hysteresis had any actual existence, and I should like to hear from Professor Ryan on this point. It is found in practice, as he stated, that with the same applied potential the insulation is much more heated when this is alternating than when direct, but is there any real evidence to show that we have hysteresis in the dielectric? The question of insulation as used in electrical machinery is not altogether one of the electrical properties of the materials, because a number of these having sufficient dielectric strength are not used owing to lack of mechanical qualities, which allow them to deteriorate under the constant vibration to which they are subjected. Micanite may be taken as an example of this. Several years ago micanite was much used for high-voltage insulation, but by reason of its deterioration under vibration and high cost it has, to a considerable extent, been replaced by other materials. Professor Ryan mentioned the use of oil, and this in its different forms is the principal insulating material now used. We have the oil in its natural form in the transformer, the oiled cloth, which is an almost universal application as an insulating material, and the enamel, which is oil in another form.

PROFESSOR RYAN: Might I say just a word with regard to dielectric hysteresis to which you refer. While I believe that dielectric hysteresis undoubtedly exists, that there is such a thing, yet in all the endeavors that we have made, we have always found in hunting down the source of heat in an insulation subjected to electric strain, that it was due to the breaking down of some weak constituent element or foreign body, gas, or whatever it may have been, in the insulation. As soon as such portions of the dielectric are broken, in lieu of the passage of displacement current, which accompanies the phenomena of electric strain, there is the passage of actual electric current, as we ordinarily know it, producing heat.

## INSULATING MATERIALS IN HIGH-TENSION CABLES.

BY E. JONA, *Delegate of Associazione Elettrotecnica Italiana.*

We have now in operation plants working at 50 to 60 kilovolts, with aerial lines. It is said that some will be installed at 80 kilovolts or even higher, but I do not believe there is any manufacturer ready to furnish cables for such high tension, although, of course, every manufacturer has occasionally had samples of cables tested as high as 100 kilovolts, without perforating them.

Let us take a glance at the conditions of manufacturing such very high-tension cables.

First, as to some theoretical difficulties. Let us suppose for the sake of simplicity, a single-core lead-covered cable with the following data:  $r$  = radius of solid copper wire;  $s$  = thickness of the insulation;  $r + s = R$  external radius of the insulation. An alternating current is flowing through the cable, at a tension  $V$ . In the limits of ordinary frequencies, we can speak of potential, and use the electrostatic laws in any section whatever of the cable. The potential at a point  $P$  (Fig. 1) at a distance  $\rho$  from the center will be then:

$$v = V \frac{\log \frac{R}{\rho}}{\log \frac{R}{r}} \dots \dots \dots (1)$$

Differentiate (1) with respect to  $\rho$ , taking decimal logarithms, and we get:

$$\frac{dv}{d\rho} = \frac{0.434 V}{\rho \log \frac{R}{r}} \dots \dots \dots (2)$$

$\frac{dv}{d\rho}$  is the gradient of the potential, or its variation along the radius. If we refer the dielectric strength of materials to the millimeter as unit of thickness (and assume for example that a given material can stand 10,000 volts per mm thickness) and

express our formula in mm,  $\frac{dv}{d\rho}$  will be the puncture stress on the dielectric per mm, at the point considered. It must be less than the dielectric strength in order not to have a break-down;

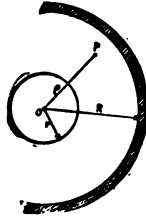

FIG. 1.

in our example, it must always be less than 10,000 volts per millimeter.

In the formula (2) putting  $r = \rho$  we have

$$\left(\frac{dv}{d\rho}\right)_r = \frac{0.434 V}{r \log \frac{R}{r}} \dots\dots\dots(3)$$

This is the stress on the small dielectric layer immediately surrounding the inner conductor. For  $\rho = R$

$$\left(\frac{dv}{d\rho}\right)_R = \frac{0.434 V}{R \log \frac{R}{r}} \dots\dots\dots(4)$$

the stress on the small dielectric layer near the outer lead.

It is to be remarked that the stress is greatest in contact with the conductor, and minimum in contact with the outer lead; and the latter is precisely equal to the former multiplied by  $\frac{r}{R}$ .  $r$  is generally very small in high-tension cables, and  $R$  very large. There is thus a very great difference in the stress on the different small dielectric layers, the most internal of which must support a tension three, four, five times that of the external layer.

There is a certain value of  $r$  for which the maximum stress  $\left(\frac{dv}{d\rho}\right)_r$  is as small as possible, for a given  $R$ ; we obtain this value of  $r$  by equating to zero the derivate of  $r \log \frac{R}{r}$  with respect to  $r$ . Hence we have:

$$\frac{r}{19} = \frac{R}{e} = \frac{R}{2.71} \dots\dots\dots(5)$$

I shall consider later the very frequent case where the conductor is not a solid wire, but a stranded one, and the relative formulas for any stranded conductor.

These brief considerations point to the conclusion that doubling the thickness of the dielectric by no means allows of doubling the dielectric stress on the cable; for the strength increases much less than the increase of thickness. Practically, for the sake of manufacturing, handling, etc., we cannot use too great thicknesses, especially if we consider also the weight of lead and armoring. If we admit that a homogeneous dielectric in a cable is punctured as soon as the stress surpasses in some point the dielectric strength, we see immediately the enormous advantage of using materials of very high specific strength. In fact, if we can with safety allow the material to be worked at  $w$  volts per mm, the formula (3) gives us immediately the thickness required.

$$w = \frac{0.434 V}{r \log \frac{R}{r}} \quad \text{whence} \quad \log R = 0.434 \frac{V}{rw} - \log r \dots \dots \dots (6)$$

This formula tells us that  $R$  diminishes rapidly by augmenting  $w$ .

A numerical example will illustrate this better. Let  $r = 10$  mm and  $V = 20,000$  volts; and suppose we have at our disposal an insulating material able to stand 12,000 volts per mm and another for only 8000 volts per mm. Let us take the same factor of safety, say one-fourth, in both cases; that is, we work at a maximum of 3000 volts per mm for the former, and 2000 volts for the latter.

In the first case we ought to have a thickness of 9.45 mm and in the second 17.20 mm. The volumes of the insulation are respectively 875 mm<sup>3</sup>, and 2000 mm<sup>3</sup>; they are in the ratio of 1 to 2.28 whilst the ratio of the dielectric strengths is as 1:1.5. In this example the volumes of the insulation vary almost inversely as the squares of the dielectric strength.

In a 40,000-volt cable, with  $r = 10$ , and  $w = 3000$  V per mm, we ought to have an insulating thickness of 66 mm; that is, a thickness impossible in practice. We see that, in this case, doubling the working tension compels us, *cæteris-paribus*, to use seven times the previous thickness. Hence it is obvious that it is not possible to manufacture 40,000-volts cables, with a material working with safety only to 3000 volts per mm.

Two insulating materials are now principally competing in the field of high-tension cables — vulcanised rubber and paper im-

pregnated with rosin and oil mixtures. Both have their partisans and their opponents. Paper insulation has made great progress in the last few years. The utility of using good manilla paper, laid on in thin and regular layers, without wrinkles and crumpling, has been recognized, and also the utility of having it properly desiccated, at a moderate temperature, in a vacuum, and impregnated with a compound of rosin, or wax, or asphalt, with mineral, or castor, or linseed, or some other oil, that does not become brittle or pulverise with age. But rubber also has made progress; and if some feared formerly that it could decay with age, it is now certain that first-class rubber cables, well vulcanised and removed from the influence of brush discharges in the air, or not alternately dry and wet, will last indefinitely.

Rubber has a dielectric strength much higher than impregnated paper. Testing good rubber cables in such lengths as to include the inevitable irregularities of manufacture, with tensions progressively increasing and subjected to dielectric strain at least one hour, we can easily obtain for the rubber a dielectric strength of 12–15 kilovolts per mm. Paper in the same conditions would only stand 8–10 kilovolts per mm. These numbers represent as good an average as we can reach in normal manufacturing; it is not rare to find 20–30 per cent more, or even higher percentages, but we cannot reckon upon these. The higher dielectric strength of rubber brings us to the conclusion that the use of rubber for very high tension will extend more and more.

A cause of inferiority of the rubber is the lesser homogeneity of its products. It is not uncommon to find that two cables manufactured in the same manner, with the same quality of rubber, afford a very different resistance to perforation — a difference, say, of 30–40–50 per cent. Paper cables are more homogeneous. The figures relative to dielectric strength given above are the result of a great number of tests made by the author on cables of various makers. They do not take account of some exceptionally high strengths; I found some pieces of rubber cable to withstand 20–25 kilovolts per mm. The elasticity of rubber gives it a great superiority over paper. A paper cable with large thickness of paper cannot be easily bent, especially in cold weather, owing to cracking; on the other hand, the manufacture of concentric, or stranded, multiple-core cables is simpler in the case of paper cables, for the insulating material can be uniformly distributed in the interspaces

among the conductors, which remain buried in the insulator. This is not possible with rubber.

The great success of paper cables is a consequence of their lower price. But very high tensions require such a greater thickness of paper, that the cost of the paper added to the extra price for the larger quantity of lead, steel, tape, etc., permits the rubber to win in the competition.

The problem of manufacturing high-tension cables would be simpler if the gradient of the potential within the body of the insulator was constant. Suppose a 38-mm<sup>2</sup> cable insulated to 14.5 mm outer radius, and working at 25,000 V. The layer near the copper supports a strain of 5,000 volts per mm, while near the lead the stress is only 1200 volts per mm. Should the stress be constant throughout, each layer of 1 mm would support a strain of 2270 volts, and the cable would be much safer. We could then also diminish the thickness of the insulation to, say, 5 mm, letting every layer work at 5000 volts.

This ideal condition of uniform gradient we can seek to reach in practice. A similar proposal was made by Mr. O'Gorman in a highly interesting paper, read before the I. E. E. London, on March, 1901; but it is difficult to imagine how Mr. O'Gorman's system can be practically applied. It consists chiefly in embedding the layers of paper more or less in some oils (like castor oil) according to their distances from the center; so that the inductive capacity of any layer is in inverse ratio to these distances.

Without claiming to get an absolutely constant gradient, we can, therefore, try to have the potential better distributed along the radius of the insulation, and at the same time use in the proper place materials having greater dielectric strength, by making the insulating layers of different materials specially chosen. This method I studied and applied to the manufacture of high-tension cables, as early as 1898. Such cables, consisting of conductors first insulated with several layers of rubber, on which were wound layers of paper or jute, were patented by Messrs. Pirelli & Company, March, 1900. A cable of this kind was working at 25,000 volts, during the Paris Exhibition of 1900.

The specific inductive capacity of paper cables varies from 3 to 4, according to the type of paper and mixture adopted. The inductive capacity of paper is about 2; that of rosin 2 to 3, according to its origin; and mixtures of rosin, oil, paraffin, ozokerite,



and other materials, have a capacity 3 to 4, or even more. For example, lubricating oil 55 parts, rosin 560, paraffine 224, ozokerite 160, have a s.i. capacity of 3.6; oxydized linseed oil 90, rosin 370, Arkangel pitch 70, have 4.4; Arkangel pitch itself has 5.9; a mixture with Gallipot, instead of rosin — for example Gallipot 600, Arkangel pitch 110 and linseed oil 130 — have 4.8; a mixture of lubricating oil 9, rosin 52, black ozokerite 23, white ozokerite 16, have only 3.55.

It appears from these figures that it is possible to have a large range of inductive capacity with paper cables. But as they are impregnated in mass, the entire mass has the same s.i.c. unless we change the type of paper, by using, for example, paper loaded with some materials, as suggested very ingeniously by Mr. O'Gorman; but I do not know if he succeeded in doing so. On the contrary, it is easy to use different rubbers having very varied s.i.c., for rubber is put on in successive layers which can be quite different one from another, and which have no tendency to mingle together, either during or after manufacture. The cables I alluded to are manufactured with layers of various qualities of rubber in the inner part of the insulation; but as soon as the gradient of potential becomes so diminished as to allow the use of paper, the insulation is continued with paper, and after the paper with jute, if the gradient is sufficiently low to allow the use of jute. The rubber insulation is generally first vulcanized and the conductor tested in water, as usual, before adding the outer layers of paper and jute.

Pure vulcanised rubber has an inductive capacity something like 3 as an average; but it is very easy to "load" the rubber with large quantities of extraneous materials, which, without sensibly lessening its specific dielectric strength, augment the capacity very much. A rubber with 58 per cent para, 2 per cent sulphur, 26 per cent talc and 14 per cent oxide of zinc, has a dielectric strength comparable to that of pure vulcanized para (15–20 kilovolts per mm); and a specific inductive capacity of 4–4.2. A rubber with 64 per cent para, 8 per cent sulphur, 16 per cent talc, 8 per cent minium, 4 per cent oxide of zinc has about the same dielectric strength as above mentioned, while its specific capacity reaches 5. A rubber largely loaded with sulphur and talc, for example para 100, talc 40, and sulphur 40, has a capacity as high as 6.10, with a dielectric strength of the same order of magnitude as before. A mixture of para 40, carbonate of lime 55,

sulphur 5, has a s.i.c. of 4.6. Very large variations of capacity, accompanied by high dielectric strength, are obtained by loading rubber with more or less sulphur and golden sulphurate of antimony still remaining first-class rubber. Much larger capacities, 10-12, are to be obtained, of course, by using very large percentages of India rubber substitutes, and gypsum, lime, baryta, etc.; but we then arrive at inferior classes of rubber, which have not a dielectric strength to be compared with the above-mentioned combinations.

It is very easy to manufacture rubber cables with layers disposed in the order of decreased specific capacity, from the center to the circumference. These cables will afford a more uniform gradient to an alternating current, and hence more safety, with equal thickness. By using paper on the rubber, as above explained, we concentrate the more costly rubber insulation in the inmost part of the cable, where its higher specific strength is actually utilised.

A single-core cable made by this method for 50 kilovolts effective tension, between the copper and the outer sheathing, has the following specifications: Conductor, 19-wire strand, each wire 3.3 mm diameter; section of copper 162 sq. mms. The strand is put in a lead tube having 18 mm outer diameter. It is insulated with a first layer of rubber, 2.5 mm thick, having a specific inductive capacity of 6.1; then with a second and a third layer of rubber of respectively 2.3 and 4.5 mm thick and 4.7-4.2 s.i.c. On the rubber there is a layer of impregnated paper 5.2 mm thick, having an s.i.c. of 4. The cable is then lead covered. The total thickness of insulation is 14.5 mm.

At 50,000 volts. the maximum strain in the first layer of rubber is 4400 volts per mm; in the second layer it is 4450 volts, in the third 4150 volts and in the paper 3250 volts per mm. With a homogeneous dielectric, the maximum strain would be 5800 volts. This cable was tested for one hour at each of the following voltages: 35,000 effective volts, 40,000, 45,000, 50,000, 55,000, 60,000, 65,000, 70,000, 75,000, 80,000, 85,000, 90,000, 95,000 and four hours at 100,000 volts without perforation. After the 80,000 volts test, its temperature was a few degrees higher than that of the room; and after four hours at 100,000 volts, 20 deg. C. higher.<sup>1</sup>

1. In order to have the same maximum stress of 4400 volts with a homogeneous dielectric, the thickness ought to be 23.04 mm; the outside radius would be 32 mm and the total volume of insulation would be doubled.

The distribution of the potential in such a cable is easily calculated. Suppose between the conductor *A* (Fig. 2) and the lead *B*, a number *n* of cylindrical rings possessing respectively a dielectric constant  $\epsilon_h$  where *h* varies from 1 to *n*; the ring  $\epsilon_h$  is limited by the radius  $r_{h-1}$  and  $r_h$ ; let *V* be the total voltage. The potential at a point *P* at a distance  $\rho_h$  in the compartment  $\epsilon_h$  is given by:

$$v = \frac{V \left( \frac{1}{\epsilon_h} \log \frac{r_h}{\rho} + \frac{1}{\epsilon_{h+1}} \log \frac{r_{h+1}}{r_h} + \dots + \frac{1}{\epsilon_n} \log \frac{r_n}{r_{n-1}} \right)}{\frac{1}{\epsilon_1} \log \frac{r_1}{r_0} + \frac{1}{\epsilon_2} \log \frac{r_2}{r_1} + \dots + \frac{1}{\epsilon_n} \log \frac{r_n}{r_{n-1}}} \dots (7)$$

which, for a single homogeneous insulation becomes  $v = V \frac{\log \frac{R}{\rho}}{\log \frac{R}{r_0}}$

as before.

The above considerations have a somewhat too theoretical appearance, and it is convenient to have them submitted to the test of

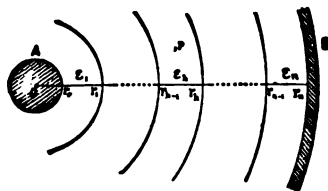

FIG. 2.

experiment. As for the distribution of potential along a radius of insulation, there can be no doubt; and experience confirms it perfectly. Experiment confirms also the distribution in an heterogeneous dielectric, taking into account the various specific inductive capacities of the layers. But experiment gives some unexpected results when we consider the perforation of the cable. The system I follow is to attach the cable to a large transformer, the potential of which is gradually raised until the cable is perforated; but any potential is applied to the cable for one hour or more, before raising it. It is then also possible to note the heating of the cable for hysteresis or conductivity. The short piece perforated is then cut off, and a test is applied to the remainder, raising the potential until a new perforation, and so on. The first thing to be noted is that results are not uniform. A length of cable

begins, for example, to be perforated at 10,000 volts, but the following perforations require 12–15 and more kilovolts. That means that our dielectrics are not homogeneous, while perfect homogeneity is presupposed in our formulæ. Another experimental fact is the following: Let us insulate a copper wire of 1/10 mm diameter, with 7 mm thickness of rubber, and, in the same manner, a strand of 70 wires, each of 0.25 mm with the same thickness of 7 mm; the former will be perforated at 10,000 volts, the latter at 22,000. The latter is a thicker conductor, and our formula shows that a thicker conductor supports more stress with the same thickness of insulation. But if we calculate with our formula the maximum specific stress in contact with the conductor—that is to say the stress which we think will cause a perforation—we find it to be 12 kilovolts per mm for the thicker conductor, and 32 for the thinner one. Similarly, I have insulated with the same thickness of 14 mm of paper, a conductor of 1 mm and another of 29 mm; the former, after one hour at 30,000 volts, was very hot and burnt at 40,000, the latter, after one hour at 50,000 volts, was still cold and burnt at 75–80 kilovolts. The maximum specific strain calculated is 10,000 volts for the thicker, and 23,500 volts for the thinner conductor. These strains of 23,500 volts per mm for the paper and 32,000 volts per mm for the rubber, are abnormally high; and the higher specific dielectric strength (apparent or real, I do not know which) that I always observed in thin insulated wires, shows that some other phenomenon exists in the dielectric.

Our formula, perhaps, lacks recognition of the mutual action of the different dielectric layers. We imagine the dielectric divided into concentric rings, for which we calculate the strain; and if it surpasses the dielectric rigidity we have assigned to the dielectric, we say that it will be perforated. Each ring is not influenced by the others, according to this manner of viewing the phenomenon, except for the distribution of potential; afterward it is considered as neither helped by nor helps the others. That is, perhaps, too statical a conception; dynamical influences are not considered here, but perforation is dynamical. It requires a certain amount of energy, which is spent not only in the first layer we have considered, but also in the others. The layers cannot then be absolutely independent. Let us take, for example, a sort of concentric cable, the inner conductor made with a copper wire 4 mm thick, insulated with jute to 8 mm; on the jute, a thin brass tape

represents the outer conductor, insulated with a layer of 3 mm vulcanised rubber; the cable is then drawn into a lead pipe. Apply an 8000-volt transformer between the inner conductor and the lead, leaving the brass tape insulated. At this tension the jute is perforated, between the copper and the brass tape; the jute is thus put out of service, and the total tension is brought on the rubber, which supports it very well. If we calculate the initial distribution of the potential, we see that the strain on the jute was 3300 volts, which is too much for this kind of insulation, which will burn. The layer of rubber cannot give any help to jute in this condition, for brass tape separates it from jute.

But if we make a cable absolutely like this, but without the brass tape, the phenomena are quite different. No doubt the distribution of potential and the gradient are unchanged. Let us put in circuit an electro-dynamometer to measure the capacity current, and we shall have the following readings at the respective tensions:

Volts	5000	7000	9000	11,000	13,000	15,000
Deflection	33	62	105	150	220	297

The deflections are in the ratio of the squares of the tensions, whence we deduce that the capacity of the cable remained unaltered, under current, after many hours testing, at potentials much higher than before. If the jute was perforated, burnt, or carbonized, the capacity ought to have increased, and the deflections would have increased more than according to a simple square law.

This mutual aid explains why it is possible to mix together very different materials and get good dielectrics. For example, there are the various mixtures of rubber, or the micanite insulations, where many layers of different capacity and strength, such as paper, mica, shellac are wrapped alternately. But if we exaggerate, we shall end by burning the weakest dielectric layers, without perforating all the cable, which still continues to work.

Such a phenomenon occurs in dielectrics, especially when of organic matters, which are never homogeneous. By testing them at too high tensions, as required by some engineers, we may destroy the more strained and weaker particles of the dielectric, without immediately perceiving it. We have thus an idea of the reason opposing too severe voltage testings, which may produce deterioration in the dielectric.

If we calculate with our formulæ the thickness required to insulate for 50,000 volts, a wire of 0.1 mm diameter, assuming

we allow the dielectric to work at 4000 volts per mm, we find a number which can be expressed in millions of kilometers better than in millimeters. Such a bare wire suspended by insulators in air can effectively transport energy at 50,000 volts, although air has, of course, much less dielectric strength than rubber. But if we observe the wire in the darkness, we remark that it becomes illuminated. It is surrounded by a very vivid brush discharge, and the wire has the appearance of a uniform cylinder of light of great diameter. We can consider that air has become a conductor, as regards the distribution of the potential, to the limit of the brush discharge; and we have no longer a conductor of 0.1 mm diameter, but one having the diameter of the brush discharge. Even if we suppose this latter to be only 5-6 mm, the millions of kilometers are reduced to two meters. That is, a wire of 0.1 mm suspended in the air, two meters from the earth, will be the seat of a brush discharge having an apparent diameter of 5-6 mm when brought to 50,000 volts, if we suppose air has a dielectric strength of 4000 volts per mm.

Such a phenomenon can, perhaps, occur in solid dielectrics, when the conductor is very thin; perhaps the very first layers of insulation become conductors as regards the distribution of the potential. This may explain the higher dielectric strain supported by very thin insulated wires to which I referred above. This fact can, perhaps, be explained also by a deficiency of adherence between the dielectric and such a thin conductor; or, perhaps, by some particular phenomenon on the surface of separation between conductor and dielectric, of which we have many examples in other branches of physics.

The influence of the diameter of the conductor on the total strength of a cable can be very well placed in evidence by taking air as an insulator. If we have an aerial line on insulators,  $1\frac{1}{2}$  meters from the earth, with wires of different diameter, say from 0.12 to 15 mm, and attach this line to one pole of a transformer, the other pole of which is attached to an insulated distant line, we remark that at a total tension on the transformer of 12,000 volts, only the 0.120-mm wire commences to show brush discharges, and that this phenomenon appears only at 185,000 volts with a 12-mm wire, while at 196,000 volts the 15-mm wire does not yet show brush discharges. (Fig. 3.) Under tension, all the wires examined in the darkness appear to have about the same diameter, which is the one that reduces the gradient below the dielectric strength of the air.

Air is a good dielectric for such researches, for we can see what happens in the dielectric. Thus, if we submit a solid wire and stranded or braided wire having all the same external size, to a very high potential, we do not see any great difference in the potential at which brush discharge commences. We can then foretell that the dielectric strength of a cable is not influenced very much

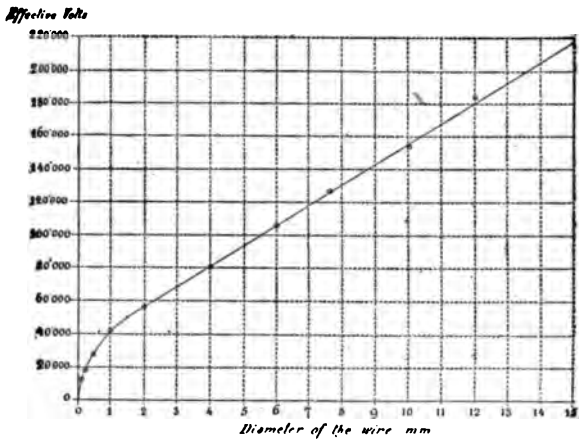

FIG. 3.— BRUSH DISCHARGE VOLTAGE FOR VARYING DIAMETERS.

by the shape of the conductor, if stranded or solid wire, at equal diameter. But it is a difficult matter to judge the phenomenon exactly by sight. I tried to take photographs at 2 meters distance with a lens of 1 meter focal distance; but photographs do not represent the phenomenon as we see it.

From another point of view, testing an insulated cable cannot give us a numerical value of the difference between a solid wire and a stranded conductor, because of the irregularities and heterogeneity of the dielectric. It would, therefore, be very useful to investigate the matter by mathematical analysis. In this very difficult problem I happily was able to interest Prof. Levi-Civita. It is not possible to examine here this complex theoretical study and I shall limit myself to a few words. Let us consider a stranded conductor, and let  $m$  be the number of the wires in the *external* layer of the strand, and  $R$  the radius of the insulation. Let  $r$  be the radius from the center of the strand to the points of contact of a wire of the external layer, with its neighbors (nodal point of the external wire layer). (Fig. 4.)

In a solid conductor of radius  $r$  insulated to a radius  $R$ , we have seen (formula 3) that the maximum gradient for a potential equal to unity is

$$G_1 = \frac{1}{r \log_e \frac{R}{r}}$$

In the strand with  $m$  wires in the external layer, we shall have:

$$G = \frac{1}{r \log_e \frac{R}{r}} F\left(\frac{1}{2}, \frac{1}{2}, 1 + \frac{1}{m}, \frac{1}{2}\right) \dots \dots \dots (10)$$

where  $\lambda = \frac{1}{r} \log_e \frac{R}{r} + 4 \sum_{v=1}^{m-1} \frac{s_{2v+1}}{2^{2v} + 1} \frac{2^{2v} - 1}{m^{2v} + 1} \dots \dots \dots (11)$

and  $s_1 = 1.5708$   $s_2 = 1.0369$ , etc.

are the sums of the inverse of the third, fifth, etc. powers of integer numbers; and  $F$  is the symbol of the hypergeometrical series of Gauss.

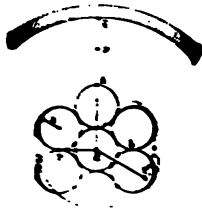

FIG. 4.

These formulas allow one to calculate the gradient, but it is well to compare the gradient of a strand to that of a solid wire of the same section. Practically the total number of the wires in a regular strand, having  $m$  wires in the external layer, is given by

$$N = 1 + \frac{m(m+6)}{12}$$

and the radius of a single wire is  $a = r \tan \frac{\pi}{m}$ , all the wires of the strand having the same radius  $a$ .

Let  $r_0$  be the radius of a solid wire having the same section as the strand, then

$$r_0 = r \sqrt{N} \tan \frac{\pi}{m} = r_0'$$



strands of  $7 \times 2.34$  mm, and  $19 \times 1.4$  mm; and partially a solid wire of 6 mm surrounded by 40 thin wires of 0.5 mm diameter. They were all insulated with 5 mm thickness of jute. If we calculate the maximum strain per mm by our formulas, we find that it is 0.32 of the total tension in the solid wire, 0.418 in the 7-wire strand, 0.424 in the 19-wire strand, and 0.432 in the strand having an external layer of 40 thin wires.

During the tests the 19-wire strand began to burn at 17,000 volts, and successively at 18-21-23-25 kilovolts; the 7-strand wire was first perforated at 19,000 volts, and successively at 20-22-24-25 kilovolts; the strand of 40 thin wires began to be perforated at 29 kilovolts, and afterward it experienced many other punctures from 29,000 to 33,000 volts. The first puncture in the solid wire was at 28,000 volts, probably a weak point, for the successive punctures were from 32 to 38 kilovolts.

It is evident that the heterogeneity of the dielectric does not allow us to deduce any numerical law from these tests, but the general conclusion is that the solid wire is the strongest, and the 7-wire strand is very little stronger than the 19-wire strand. That is in accordance with theory, but the strand of 40 thin wires ought to be the weakest of all, according to pure theory; whereas though less strong than solid wire, it is stronger than the other strands. But as I remarked above, theory points to a maximum strain for  $m = \infty$ , while  $m = \infty$  is physically equal to a solid wire; and we must admit that, in the case of  $m = 40$ , the physical average which we alluded to commences to have a great influence on the result.

Of course theory cannot foretell such complex phenomena. First of all, theory considers dielectrics perfectly homogeneous; and, secondly, it cannot take into account the mutual aid of the neighboring layers, or molecules, which tends to equalize the gradient in any elementary zone. We must then be very careful in applying the results of theory. Theory must be for us like a lighthouse for sailors; we can use it to direct our course, but we do not depend upon it indefinitely to save us from wreck. For example, we found that with a given  $R$ , the maximum safety is obtained by taking  $r = \frac{R}{\epsilon}$ . High-tension cables have generally  $r$  smaller than the above ratio. After having calculated  $R$ , we might be tempted to augment  $r$  till that ratio was reached, as well as in the case where this thicker  $r$  is useless to carry the current; or we could imagine making the conductor of aluminum, thicker and more economical.

responds to  $m = 6$  with a very large thickness of dielectric; the latter corresponds to  $m = \infty$  and  $\frac{R}{r'} = 2$  — that is to a thickness of dielectric very small in practice. In the most favorable case, the ratio being 1.232, it is advisable not to use stranded conductors for very high-tension cables, but to cover the strand with lead sheathing.

We may observe that for  $m = \infty$ , the gradient tends toward its highest value — higher than with a solid wire inscribed or circumscribed with respect to  $m$ . This is not so strange, for the value of  $G$  affects only the small layer near the conductor, and however great  $m$  may be, we shall always have an external layer of small circles, having  $G = 0$  at the nodal points  $b$  of the external wires, and  $G$  a maximum at the loop points  $A$ . (Fig. 4.) This is true from a mathematical point of view; but, physically, we have some compensation between the maximum and the minimum, which will bring the value of the coefficient to unity; that is, physically, we shall have for a very great  $m$  the same value as with a solid wire.<sup>1</sup>

Experience confirms these deductions. I took a cable whose conductor was partially a solid wire 7 mm in diameter; partially

1. From Prof. Levi-Civita's formulas we can compare the capacity of a solid wire  $r'$  insulated to  $R$  with the capacity of a stranded conductor of equal section, insulated to  $R$ .  $r$  being, as usual, the radius of the knot-points of the strand, the capacity of the strand is

$$C_m = \frac{x}{2} \frac{1}{\log_{\epsilon} \frac{R}{r} - \mu} \dots\dots\dots (16)$$

where  $x$  is the specific inductive capacity. This formula is true also for an irregular strand; for example, a thick copper wire, surrounded by a number  $m$  of smaller wires, as used in some submarine cables.

Introducing the conception of the solid wire of equal section we have, taking decimal logarithms:

$$C_m = \frac{x}{2} \frac{0.434}{\log_{10} \frac{R}{r'} - 0.434 (\mu - e)} \dots\dots\dots (17);$$

while for the solid wire cable we have:

$$C = \frac{x}{2} \frac{0.434}{\log_{10} \frac{R}{r'}}$$

As  $\mu - e$  is always positive and increases with  $m$ , we conclude that  $C_m > C$  and increases with  $m$ . At the limit, for  $m = \infty$

$$C_{\infty} = \frac{x}{2} \frac{0.434}{\log_{10} \frac{R}{r'} - 0.042} = \frac{x}{2} \frac{0.434}{\log_{10} \frac{R}{r}}$$

Generally, the thickness of the insulation is greater than the radius of the conductor and therefore  $\log_{10} \frac{R}{r'}$  is generally  $> \log_{10} 2 = 0.301$ ; therefore the increase of the capacity attains practically only a very small percentage.

strands of  $7 \times 2.34$  mm, and  $19 \times 1.4$  mm; and partially a solid wire of 6 mm surrounded by 40 thin wires of 0.5 mm diameter. They were all insulated with 5 mm thickness of jute. If we calculate the maximum strain per mm by our formulas, we find that it is 0.32 of the total tension in the solid wire, 0.418 in the 7-wire strand, 0.424 in the 19-wire strand, and 0.432 in the strand having an external layer of 40 thin wires.

During the tests the 19-wire strand began to burn at 17,000 volts, and successively at 18-21-23-25 kilovolts; the 7-strand wire was first perforated at 19,000 volts, and successively at 20-22-24-25 kilovolts; the strand of 40 thin wires began to be perforated at 29 kilovolts, and afterward it experienced many other punctures from 29,000 to 33,000 volts. The first puncture in the solid wire was at 28,000 volts, probably a weak point, for the successive punctures were from 32 to 38 kilovolts.

It is evident that the heterogeneity of the dielectric does not allow us to deduce any numerical law from these tests, but the general conclusion is that the solid wire is the strongest, and the 7-wire strand is very little stronger than the 19-wire strand. That is in accordance with theory, but the strand of 40 thin wires ought to be the weakest of all, according to pure theory; whereas though less strong than solid wire, it is stronger than the other strands. But as I remarked above, theory points to a maximum strain for  $m = \infty$ , while  $m = \infty$  is physically equal to a solid wire; and we must admit that, in the case of  $m = 40$ , the physical average which we alluded to commences to have a great influence on the result.

Of course theory cannot foretell such complex phenomena. First of all, theory considers dielectrics perfectly homogeneous; and, secondly, it cannot take into account the mutual aid of the neighboring layers, or molecules, which tends to equalize the gradient in any elementary zone. We must then be very careful in applying the results of theory. Theory must be for us like a lighthouse for sailors; we can use it to direct our course, but we do not depend upon it indefinitely to save us from wreck. For example, we found that with a given  $R$ , the maximum safety is obtained by taking  $r = \frac{R}{\epsilon}$ . High-tension cables have generally  $r$  smaller than the above ratio. After having calculated  $R$ , we might be tempted to augment  $r$  till that ratio was reached, as well as in the case where this thicker  $r$  is useless to carry the current; or we could imagine making the conductor of aluminum, thicker and more economical.

But we should not forget that the heterogeneity of dielectric would cause this to be dangerous: with an impurity present we have a smaller range of thickness to rely upon, and the cable would then break down. We can, of course, augment  $r$  a little, but less than theory indicates. I have followed this practice for some time with very high-tension cables; the wire strand is covered with a lead tube, which augments its diameter. The lead has also the advantage of rendering the conductor round, and of preserving rubber from contact with copper in rubber cables, or in cables whose insulation is composed of rubber and paper, as I have explained above.

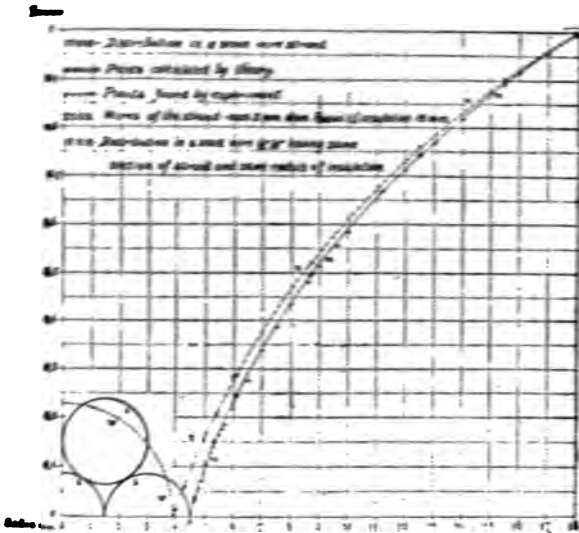

FIG. 5.— POTENTIALS AT SUCCESSIVE RADII.

It is said that a manufacturer has found it advantageous to surround the stranded conductor with a layer of thin wires, (say 1.4 mm in diameter) separately wrapped with a small thickness of paper; these wires are connected with the strand, so that no difference of potential exists between the strand and the wires. It is said that a gain of 20-25 per cent was thus found in the dielectric strength of the cable. I have not a large experience with such a type of cable, but some experiments I have made do not point to an advantage, and it would be difficult to explain why there should be an advantage with this type; the small wires of the external layer become separated one from the other, so that equipotential lines must bend very much. If the advantage really exists, perhaps it is to be attributed to the larger specific dielectric strength of thin insulated wires, to which

I referred above, but in this case, would it not be better to use an external layer of thinner wires, laid on contiguously, without any special insulation on each wire? Some experiments which I have made seem to point that way.

We can also test the theory by calculating the value of potential along a radius, and checking it in an experimental or model cable obtained by soldering a strand conductor and a ring upon a thin metallic sheet, and letting a current flow in the sheet from the strand to the ring. Potentials can thus be easily measured. Fig. 5 shows the theoretical curve and the experimental one, which are very much alike.<sup>2</sup>

The above considerations allow us to calculate single-core cables. Three-phase cables can be calculated by considering one conductor

<sup>2</sup> This theoretical curve  $\rho = f(v)$  is obtained from the following formulae where  $r$  is the potential, whose value is zero in the inner conductor and 1 in the lead sheathing.  $r, R, \mu, F$  have the meanings I have already explained: It is to be remembered that  $F(a, \beta, \gamma, \alpha)$  is the symbol of the hypergeometrical series of Gauss.

$$1 + \frac{\alpha}{1} \frac{\beta}{\gamma} \alpha + \frac{\alpha(\alpha+1)}{1.2} \frac{\beta(\beta+1)}{\gamma(\gamma+1)} \alpha^2 + \frac{\alpha(\alpha+1)(\alpha+2)}{1.2.3} \frac{\beta(\beta+1)(\beta+2)}{\gamma(\gamma+1)(\gamma+2)} \alpha^3 + \dots$$

$\rho$  is the radius of the point  $P$  taken along a radius  $OA$  passing to a loop point  $A$ ; (Fig. 4) the potential at  $P$  has the value  $v$ .

Putting  $s_1 = \epsilon^{\mu} \cdot \left(\frac{r}{R}\right)^m$   $s = \frac{s_1^v}{1 + s_1^v}$ , we have:

$$\rho = r \left(\frac{R}{r}\right)^v \cdot \epsilon^{\mu(1-v)} \cdot \frac{F\left(\frac{1}{2}, \frac{1}{2}, 1 - \frac{1}{m}, s\right)}{F\left(\frac{1}{2}, \frac{1}{2}, 1 + \frac{1}{m}, s\right)}$$

The experimental curve was obtained in a model made to a scale  $\frac{10}{1}$ ; the conductor is a 7-wire strand, each of 3 mm diameter (30 mm in the model) insulated to a radius  $R = 18$  mm (180 mm in the model).

Values of	In a strand of			
	7 wires, $m = 6$ .	19 wires, $m = 12$ .	37 wires, $m = 18$ .	$m = \infty$ .
$F^2\left(\frac{1}{2}, \frac{1}{2}, 1 + \frac{1}{m}, \frac{1}{2}\right)$	1.81	1.84	1.85	1.89
$\mu$	0.484	0.289	0.187	0
$\epsilon^{-\mu}$	0.615	0.794	0.854	1
$\epsilon^{-\mu} \cdot F^2$	0.896	1.05	1.152	1.89
$\frac{r}{a}$	1.739	3.732	5.67	....
$0.484(\mu - e)$	0.023	0.034	0.036	0.043
$\epsilon^{\mu} - e$	1.023	1.081	1.087	1.107

at a potential, of say,  $\frac{V}{\sqrt{3}}$  volts; we get then the radius of the insulation around each conductor. We can consider afterward the same conductor to be insulated for  $V$  volts; we get then the distance between the center of this conductor and the lead, and, therefore, the thickness of the extra insulator around the strand of the three insulated cores. The factor of safety for this extra insulation need not absolutely be the same as for the former, as it corresponds to an abnormal case of a phase break-down. Compound cables, with rubber, paper and jute, are calculated according to the respective dielectric strengths of these materials, distributed in the depth of the dielectric, according to the radial gradient.

Gutta-percha possesses also very great dielectric strength, comparable to that of good rubber, 15–20 kilovolts per mm. It is not used for insulating cables for lighting or power purposes, because of its very high price, and especially from its low melting point. Such cables can easily reach a temperature which softens gutta-percha. A possible application of gutta-percha is for cables crossing lakes, rivers, and, generally speaking, for laying in cold water. It is then advisable to make a first layer of rubber insulation, on which gutta-percha is laid so that the latter, being in contact with external cold water, cannot heat very much. Many manufacturers do not trust the impermeability of rubber cables, and this external coat of gutta-percha, absolutely waterproof, adds its own dielectric strength to that of rubber and obviates the inconvenience of having a heavy lead pipe, as employed by the manufacturers to which I have alluded. It is often advisable in such cables to avoid splices, and for the sake of facility of transport and laying, they can be single-cored, rather than three-cored. I may add that single-core cables for very high tensions, requiring generally a low current strength, can often be armored with steel wires; the steel wires can be separately wrapped with tarred manilla, in order to lessen the section of the metal and increase the magnetic and electric resistance of the cross-circuit. For example, a 2.5-mm steel wire wrapped to 5–6 mm with manilla, may be used without any great inconvenience from hysteresis or self-induction; the drop of pressure by self-induction can have in such cables no more importance than the drop by ohmic resistance.

I would like to add something on the properties of various insulating materials, but I fear I have already passed the limit set for

papers. I shall, therefore, only say that these materials are influenced by Röntgen rays, which lessen their specific insulation and perhaps also their dielectric strength. But cables are not made to be submitted to such rays, although they often experience brush discharges and some other emanations, which may have similar influences. I should like to add that temperature lessens the resistance of the insulation very quickly, as expressed in megohms. A paper cable at 35 deg. C. shows but one-thirtieth of the megohms it has at 15 deg. C. But temperature has very little influence upon strength to resist breakdown. Palm oil melted at 50 deg. C. gives a strength corresponding to that of the best oils for transformers at ordinary temperature. I have drawn experimental curves of dielectric strength of melted paraffine at 55 deg. C. and at 85 deg. C. from 10 up to 160 kilovolts; they are very similar. This allows us to conclude that in this respect cables cannot differ very much. I have tested two reels of paper cables, each cut in 5 pieces, immersed in baths at 0 deg., 15 deg., 35 deg., 70 deg. and 100 deg. C. The dielectric strength did not lessen by raising temperature, perhaps at 0 deg. it was less than at 70 deg. I noted in some oils something similar, but dielectric strength is too complex a phenomenon to be discussed on small experimental differences. Of course, that cannot justify us in working at high tensions with cables too much heated, for it is probable that heat would facilitate a chemical decay of the dielectric; but a momentary elevation of temperature is not so much to be feared as one would think at first sight.

In conclusion I may say that the above considerations can be applied to some other matters. They explain, for example, the brush discharges between the petticoats of insulators. An insulator with many petticoats can be considered like a system of condensers in series; a large part of the tension is taken by air, which has 3 to 4 times less specific inductive capacity. They explain the "digestion" of the wooden pins with iron cores, in the insulators; for the gradient is greatest in the pins, and they become carbonised with age. They explain also the phenomenon that insulators tested with pins stand less than when tested with water, for water offers a larger and smoother surface. They explain the brush discharge at the surface of an insulated wire, drawn into a metallic pipe (for example in crossing a wall), for we have added in this case an external layer of air to the solid insulation; but air has a low s.i.c., and, therefore, it absorbs much tension, with a too

large gradient. In a similar manner we can explain the brush discharges at alternators, during very high-tension tests. These considerations explain also why the alternator coils separately wound, and wrapped with alternate layers of tapes and varnishes, are generally perforated in a corner of the coil, or corresponding to an external corner of the conductor, for there is here a higher gradient. They suggest some improvements in the construction of insulated coils for alternators, for example, by increasing the radius of curvature of the bunch of conductors,<sup>2</sup> or, by employing in the innermost part of the insulation some material like mica, which has the highest s.i.c., together with the highest dielectric strength against puncture. In short, they explain many facts which have been observed in practice.



## INDEX OF SUBJECTS.

---

- AIR-BLAST** transformer, 13.  
fire risk of, 13.
- Air-gap** for lightning arrester, 54.
- Alternators**, different types of, 70.
- Aluminum**, 101  
conductors (see **Conductors**),  
79.  
protection of, 104.  
cost of, 101.  
elasticity of, 120.  
expansion coefficient of, 120.  
for insulated cables, 102.  
manufacture, state of art, 104.  
104.  
physical characteristics of, 101.  
position as a conductor, 104.  
spans, 46.  
stress and strain diagram, 124.  
tables of physical properties,  
113-115.  
uses of, 101.  
wire, stranded, 103.
- Anemometer** correction factor, 135.
- BAY COUNTIES** system, Colgate power-  
house, organization of,  
223.  
Lake Francis system, or-  
ganization of, 220.  
line construction, organiza-  
tion of, 225.  
organization of, 215.  
organization of whole sys-  
tem, 220.  
Power Co., 31, 215.
- Bus-bars** of aluminum, 102.
- CABLES**, 127.  
aluminum, deflections of, 114.  
temperature rise for differ-  
ent lengths of span, 115.  
calculation of sag, expansion,  
etc., 133.  
copper, strength of, 127.  
vs. aluminum, 132.  
elasticity for various metals,  
120.  
insulated aluminum, 102.  
steel, strength of, 128.
- California Gas & Electric Corpora-  
tion**, 31.
- Capacity current** of transmission  
line, 33.
- Catenary** formula, 115.
- Charging current** of transmission  
line, 33.
- Charring** of pins, 77.
- Coils**, transformer, support of, 11.
- Conductivity** of aluminum, 101.
- Conductors**, 78.  
aluminum, 79, 101.  
cost of stringing, 104.  
deflection of, 109, 134.  
in sleet, 104.  
joints, how made, 134.  
maximum sag, 132.  
protection of, 104.  
sag for, 187.  
sag-span diagram, 132.  
spacing of, 105.  
splice joint, 104.  
strength of, 124.  
stringing of, 104, 186.  
tables of properties, 113-  
115.  
cables (see **Cables**).  
calculation of deflection, 116.  
copper, 78, 110.  
deflection of, 109.  
manufacture of, 120.  
maximum sag, 131.  
sag-span, diagram, 131.  
strength of, 121.  
cost of, 101.  
elasticity for various metals,  
120.  
for long spans, 111, 119.  
formula for diameter of, 266.  
ice on, 130.  
iron, 78, 125.  
strength of, 125.  
properties required of, 128.  
relative weight of various ma-  
terials, 129.  
sag of, 111.  
steel, 125.  
stranded aluminum, 103.  
transposition of, 188.  
wind pressure, 130.  
experiments, 105, 106.

- Copper, cables, stress and strain diagram, 127.  
 conductors (see Conductors), 78.  
 cost of, 101.  
 elasticity, 129.  
 expansion coefficient, 129.  
 physical constants, 110.  
 stress and strain diagram, 121-123.  
 time and strain diagram, 123.  
 wire, 120.  
     manufacture of, 120.
- Cost formulas, 261.  
     of transformers as affected by artificial cooling, 22.
- Cross-arms, 75.
- Cross-currents, 239.
- DEFLECTION of conductor, calculation of, 116.
- Delta and Star connections, merits of, 73.  
     connection of transformers, 15.
- ELASTICITY, aluminum, 101.  
     of various conductor materials, 129.
- Electric power transmission (historical), 1.  
     over long distance (first), 4.
- Electro-static field around high tension insulator, 159.
- Entrance of lines into buildings, 46.
- Expansion, aluminum, 101.  
     of the conductor-metals, 129.
- FEEDERS, low voltage aluminum, 103.
- Fire at Colgate, cause of, 22.
- Fire-proof construction, 20, 21.  
     floors, 20.
- Fire protection, 71.
- Fire risk in transformers, a method of reducing, 14.  
     of air-blast transformers, 13.  
     oil-insulated transformers, 14, 22, 23, 47.  
     transformers, 13, 20.  
     various types of transformers, 71.  
     with concrete floors, 20.
- Floor (concrete) in fire, 20.
- Fog and smoke, 74.  
     salt-sea, 79.  
     troubles, 54.
- Frequency, 70.  
     selection of, 70, 187.
- Fused switches, 72.
- Generators, inductor, 71.  
     revolving field vs. revolving armature, 70.  
     voltage, 71.
- Glass, 165.  
     and porcelain, 136.  
     insulators, 76.  
     vs. porcelain, 165.
- Grounded neutral, 15, 53.
- Guanajuato insulator, 143.
- HIGH-TENSION control, 44.  
     lines, entrance of, 46.  
     switching, 72.  
     transformers, 25-30.
- Horn lightning arrester, 58.  
     vs. multiple gap arrester, 64.
- Hydraulic system of Bay Counties system, 215.
- Ice on conductors, 130.
- Idle currents, 239.
- Induction regulators, 249.  
     cost of, 251.
- \* Inductive drop in transmission lines, 42.
- Inductor generators, 71.
- Installation of Niagara Falls Power Company, 3.
- Insulation, damage from smoke, 73.  
     design of, 159.  
     of high-tension lines, 152.  
     transformers, 11.  
     from earth, 20.  
     (oil) as affected by moisture, 23.  
     test of transformers, 47.
- Insulator dimensions, 77.  
     pins, 46.
- Insulators, 44, 76, 136.  
     breakdown of, 169.  
     cost of, 151.  
     distribution of electro-static strain, 165.  
     potential, 163.  
     electrical and mechanical requirements of, 148.  
     evolution of, 138.  
     experimental high-tension, 149.  
     failure of, 179.  
     fastening of, to iron pins, 176.  
     glass, 76.  
     high-tension, 142.  
     in American practice, 166.  
     requirements of, 145.  
     history of, 138.  
     material for, 227.  
     mushroom type, 141.  
     porcelain, 76.  
     possible wet surfaces, 163.

- Insulators — (*Continued*):  
 selection of, 178.  
 strains on, 166.  
 studies on elementary forms,  
 160.  
 surface leakage, 169.  
 testing of, 147.  
 weight of, 144.
- Iron conductors, 78.  
 elasticity of, 129.  
 pins, 77.  
 wire, 125.  
 stress and strain diagram,  
 125.
- LEAKAGE, 169.
- Lightning, 246.  
 arrester air gap, 54.  
 operation of, 55.  
 arresters, 50, 80, 180.  
 horn type, 58.  
 horn vs. multiple gap, 64.  
 limitations of non-arcing  
 type, 80.  
 short circuit in, 56.  
 discharges, 180.  
 protection, 195.
- Line calculations, 33.  
 construction, 46, 74.  
 operation, 47.  
 patrol, 80.  
 voltage, 54.
- Lines, high voltage aluminum, 103.
- Load factor of plants in parallel,  
 234.
- Long spans, 111, 119.
- MAGNETIC circuit of transformers,  
 11.
- Materials used for pins, 78.
- Melting point, aluminum, 101.
- Missouri River insulator, 142.
- Multiple gap vs. horn arrester, 64.
- NEUTRAL grounded, 15, 53.
- Nevada County Electric Power Co.,  
 31.
- Niagara Falls Power Company, 3.
- OIL-COOLED transformers, 12.
- Oil-insulated transformers, a method  
 of reducing fire risk in,  
 14.  
 fire risk of, 14, 18.
- Oil, purification of, 22.  
 radiation of heat to iron, 21, 22.  
 switches, 47, 72.  
 (transformer) care of, 47.  
 specifications for, 14.  
 test of, 14.
- Operating force of large system, 219.
- Operation of long distance transmis-  
 sion lines, 47.
- PARALLEL operation of power-plants,  
 231.
- Pins, 46.  
 causes of burning of, 164.  
 charring of, 77, 182.  
 iron, 77, 175.  
 fastening to insulators, 176.  
 vs. wood, 168, 172, 189,  
 190, 191, 193, 227.  
 materials used for, 78.  
 steel, cost of, 182.  
 vacuum treatment of, 190.
- Pole dimensions, 74.  
 height, 74.  
 line, 74.  
 interruptions on, 182.
- Poles, burning of, 183.  
 (green), treatment of, 183.  
 life of, 75, 182.  
 material used for, 74.  
 treatment, cost of, 183.  
 wooden, 152.
- Pole-top construction, 174.
- Poly-phase transformers, 15.
- Porcelain and glass, 136.  
 brown and white glaze, 175.  
 insulators, 76.  
 vs. glass, 165.
- Power, cost of, as affected by pure  
 water, 7.  
 factor meters, use of, 239.  
 plants in parallel, 236.  
 house, general arrangement of,  
 53.  
 maximum amount which can be  
 carried by a line, 43.  
 plants operated in parallel, 231.  
 transmission apparatus, 2.  
 as affected by surges, 43.  
 first long distance, 4, 8.  
 historical, 1, 5.  
 in England, first, 7.  
 maximum distance of, 252.  
 relation between distance  
 and drop, 257.  
 and k.w. output, 260.  
 and voltage, 256.  
 and diameter of con-  
 ductor, 258.
- Pressure rise due to charging cur-  
 rent on line, 35.
- REACTANCE in transformers, 11.  
 pressure of transmission line,  
 34.

- Regulation of transformers, 15.  
     transmission systems, 36.  
         with synchronous motors, 61.
- Regulators, induction, 249.
- Revolving field generator, 70.
- Right of way, 73.
- SACRAMENTO** Gas and Electric Rail-  
 way Co., 31.
- Sag of conductors, 111.
- Shawnigan-Falls insulator, 142.
- Siemen's arrester, 180.
- Sleet, 74, 104.  
     on high-tension wires, 112.
- Smoke and fog, 74.
- Soldering aluminum, 101, 102.
- Spark distances, 82, 93.
- Spark distance as affected by  
 ground, 88.
- Spark-gap apparatus, 83.
- Speed regulation of plants in paral-  
 lel, 236.
- Standard Electric Co., 31.  
     voltages, 68.
- Standards in practice, 67.
- Star and Delta connections, merits  
 of, 73.  
     connection of transformers, 15.
- Static discharges in air-blast trans-  
 formers, 13.
- Station voltage, 71.
- Steel cables, stress and strain dia-  
 grams, 128.  
     elasticity of, 129.  
     expansion coefficient, 129.  
     wire, 125.  
         stress and strain diagrams,  
         126.
- Strain diagrams, 121-128.
- Strength, aluminum, 101.
- Stress diagrams, 121-128.
- Surge voltage, 44.
- Surges, effect on amount of power  
 transmitted, 43.  
     on transmission lines, 40.  
         systems, 60.
- Switch (oil), 60,000 volt, 47.
- Switches for transmission systems,  
 47.  
     high-tension, 72.  
         air-break, 245.  
         mounting of, 217.
- Switching, high-tension, 72.
- TELEPHONE** circuit, installation of,  
 188.  
     (first), 1.  
     wires of aluminum, 102.
- Telluride Power Co., pioneer work  
 on, 198.
- Towers, 46, 75.  
     cost of, 46.  
     life of, 75.  
     steel vs. wood, 119.
- Transformer case, 11.
- Transformers, air-blast, 13.  
     fire-risk of, 13.  
     static discharges in, 13.  
     case ribs, 19, 21.  
     classification of, 10.  
     coils, mechanical support of, 11.  
     cooling of, 12.  
     corrugated cases, 21.  
     cost as affected by the efficiency,  
     19.  
     Delta connection of, 15.  
     design of 300,000 volt, 29.  
         500,000 volt, 28.  
     efficiency of, 15.  
     fire-risk of, 20.  
     for long distance transmission  
     lines, 47.  
     grounded neutral, 15, 53.  
     high-tension, development of,  
     9, 10.  
         progress of, 16.  
     insulation from earth of, 20.  
     insulation of, 11.  
         test of, 47.  
     magnetic circuit of, 11.  
     oil-cooled, 12.  
     oil-insulated, 12.  
         a method of reducing fire-  
         risk, 14.  
         fire-risk of, 14, 18, 22, 23.  
     oil-insulation as affected by  
     moisture, 23.  
     oil, specifications for, 14.  
     polyphase, 15.  
     radiation of, 21, 22.  
     reactance in, 11.  
     regulation of, 15.  
     relative fire-risk of, 13, 71.  
     self-cooling, 12.  
         limitations of, 12.
- Star and Delta connections, 73.  
     connection of, 15.  
     or Delta connections, 245.
- types of, 71.
- ventilation of, 11.
- water-cooled, 12.
- water-cooling, effect upon cost  
 of, 22.
- winding of, 11.
- Transmission line calculation, 33.  
     charging current, 33.  
     inductive drop, 34, 42.  
     limit of power carrying  
     capacity, 43.  
     opening under load, 40.

- Transmission — (Continued) :**  
 short circuit, 40.  
 reactance pressure, 34.  
 regulation with synchronous motor, 61.  
 surges on, 60.  
 volts per mile, 69.  
 lines, all-steel construction, 228.  
 all-wood construction, 210, 212.  
 arrangement of, 240.  
 causes of interruption of, 177.  
 of short circuits, 244.  
 clearing of short circuits, 245.  
 climatic conditions, 178.  
 conductors (see Conductors),  
 for, 153.  
 construction and insulation of lines, 152.  
 cross-arms, 75, 153.  
 difficulties in, 177.  
 first high-tension, 140.  
 fog, 54, 74, 175.  
 general design of, 152.  
 insulation of, 159.  
 insulators, 44, 76.  
 lightning arresters, 50, 80.  
 horn vs. multiple gap, 64.  
 disturbances, 246.  
 line construction, 46.  
 patrol, 80.  
 long spans, 228.  
 pins, 46, 77, 153.  
 poles for, 74, 75, 153.  
 pressure rise due to charging current, 35.  
 rain on, 228.  
 sag, 131.  
 short circuits on, 181.  
 sleet on, 112.  
 smoke, 74.  
 spans, 131.  
 steel towers, 157.  
 surge voltage on, 44.  
 surges, 40.  
 swinging of wires, 135.
- Transmission — (Continued) :**  
 towers, 75.  
 troubles on, 179.  
 of power as affected by surges, 43.  
 plant (first long distance), 4.  
 systems, operation, 47.  
 regulation of, 36.  
 switches, 47.  
 switching, 72.  
 transformers, 47.  
 unexpected sources of trouble, 183.  
 voltage, 54.  
 limitations of, 65.  
 Two-phase transmission, 72.
- VACUUM** treatment, 190.  
 Valley Counties Power Co., 31.  
 Ventilation of transformers, 11.  
 Voltage (economical), formula for, 265.  
 for various spark distances, 82.  
 on transmission line, 54.  
 rise due to opening short circuit, 62.  
 station, 71.  
 (working), limitations of, 65.  
 Voltages, standard, 68.  
 Volts per mile, 69.  
 (reactance) in line, 34.
- WATER**, pure (effect on cost of power), 7.  
 resistance, effect on e.m.f. curve, 83.  
 spark distance, 84.  
 Water-cooled transformers, 12.  
 Wave form, 83.  
 Weight, aluminum, 101.  
 relative, of different conductor metals, 129.  
 Wind pressure, 105, 106, 130, 135.  
 formula for, 106.  
 velocities, maximum, 107.  
 Winding of transformers, 11.  
 Wood used for pins, 78.  
 poles, 75.
- Yuba Electric Power Co., 31.

# INDEX OF AUTHORS.

[D indicates discussion.]

- BAUM, F. G.**  
The Colgate Fire and the Fire Risk of Oil Type Transformers (D), 22.  
High-Potential, Long-Distance Transmission and Control, 31.  
Discussion, 54.
- Bell, Louis.**  
Early State of the Art of Electric Power Transmission (D), 5.  
Fire Danger of Oil-Cooled Transformers (D), 20.  
Long-Distance Transmission (D), 56, 58, 60, 63.  
Spark Distances (D), 97.  
Bluntness of the Needle and Spark Distances (D), 98, 99.  
Effect of Condenser Action of Guard Plates on Spark Distances (D), 100.  
Insulator Design (D), 172.  
Insulator Pins (D), 190, 191.  
Insulator Sleeve (D), 192.  
Vacuum-Treated Pins (D), 192.
- Blackwell, Francis O.**  
High-Tension Transformers (D), 18.  
Insulating Value of Transformer Oil as Affected by Moisture (D), 22.  
California Gas and Electric Corporation Plant (D), 61.  
Conductors for Long Spans, 119.
- Buck, H. W.**  
The Use of Aluminum as an Electrical Conductor, 101.  
Discussion, 134.
- Bunker, A. C.**  
Some Difficulties in High-Tension Transmission and Methods of Mitigating Them, 177.  
Discussion, 189.  
Insulator Pins (D), 180, 191.  
Glass Shields (D), 191.  
Fog Troubles (D), 192.  
Burning of Pins (D), 193.  
Lightning (D), 195, 196.  
Effect of Rain on Line Insulation (D), 197.
- CABINI, F.**  
Insulators and Insulator Pins (D), 175.
- Converse, V. G.**  
High-Tension Insulators, 136.  
Insulators and Pins (D), 170.  
Testing of Insulators (D), 175.
- Creaghead, T. J.**  
Line Switch on Long-Distance Transmission Lines (D), 61.  
Fastening of Insulators to Iron Pins (D), 176.
- FISHER, H. W.**  
Spark Distances Corresponding to Different Voltages, 82.  
Bluntness of the Needle and Spark Distances (D), 98, 99, 100.  
Effect of Condenser Action of Guard Plates on Spark Distances (D), 100.
- GEBBY, M. H., JR.**  
Long-Distance Transmission (D), 57, 58.  
The Construction and Insulation of High-Tension Transmission Lines, 152.  
Discussion, 168.  
Insulator Pins (D), 175.  
Factor of Safety on Insulators (D), 176.
- Gray, R. K.**  
Joints in Aluminum Conductors (D), 134.
- HANCOCK, L. M.**  
The Bay Counties Power Company's Transmission System, 215.
- Hayward, R. F.**  
Some Practical Experiences in the Operation of Many Power Plants in Parallel, 231.
- Hutton, R. S.**  
Water Conditions in California (D), 7.  
Long Spans on the Pacific Coast (D), 135.  
Insulators (D), 173.

- Hutton, R. S.—(Continued):  
 Lightning Arresters (D), 195.  
 Lightning (D), 196.  
 Induction Regulator (D), 251.
- KELLY, J. F.  
 Some Difficulties in High-Tension Transmission and Methods of Mitigating Them, 177.
- LINCOLN, P. M.  
 Supports in Transmission Lines (D), 135.
- MERSON, RALPH D.  
 Maximum Distance to Which Power Can Be Economically Transmitted, 252.
- Moran, Wm.  
 Long Distance Transmission (D), 54, 55, 56, 60, 61, 64.
- NEALL, N. J.  
 Lightning Arresters (D), 55.  
 56, 63, 64.  
 Insulator Sleeves (D), 192.  
 Metal Pole Construction (D), 196.
- Nunn, P. N.  
 Deflection of Aluminum Conductors (D), 134.  
 Wooden Pins (D), 193.  
 Leakage (D), 194.  
 Metal Pins (D), 196.  
 Pioneer Work of the Telluride Power Co., 198.  
 Discussion, 212.  
 Lightning Arresters (D), 249.  
 Power Factor Regulation (D), 251.
- OGLE, E. F.  
 Freezing of Snow on Insulators (D), 57.
- PECK, JOHN S.  
 The High-Tension Transformer in Long-Distance Power Transmission, 9.  
 High-Tension Transformers (D), 21.
- Perrine, F. A. C.  
 Self-Cooled Transformers Made in the United States (D), 21.  
 Long-Distance Transmission (D), 55, 56, 57, 58, 62, 63.  
 American Practice in High-Tension Line Construction and Operation, 67.
- Perrine, F. A. C. (Continued):  
 Insulator Design (D), 171.
- RUFFNER, C. S.  
 Induction regulators (D), 249.
- Ryan, Harris J.  
 Some Elements in the Design of High-Pressure Insulation, 273.  
 Dielectric Hysteresis (D), 287.
- SCOTT, CHAS. F.  
 Electrical Power Transmission, 1.  
 Discussion, 4.  
 High-Tension Transformers (D), 18.  
 Lightning Arresters (D), 65.  
 Materials Used in Electrical Work (D), 100.  
 Aluminum Conductors (D), 134.  
 The Problem of High-Tension Insulators (D), 151.  
 High-Tension Lines (D), 170.  
 Insulator Pins (D), 194.  
 High-Voltage Work (D), 196.  
 Human Side of Transmission Work (D), 213.  
 Plants Operated in Parallel (D), 250.
- Scott, E. Kilburn.  
 Electric Power Transmission (D), 6.  
 High-Tension Transformers (D), 19.  
 Insulators (D), 173.  
 Insulator Pins (D), 195.  
 Monkeys and White Ants (D), 196.  
 Insulation of Small Motors (D), 286.
- Skinner, C. E.  
 Spark Distances (D), 98.
- Smith, Harold B.  
 Notes on Experiments with Transformers for Very High Potentials, 25.
- THOMAS, P. H.  
 Long-Distance Transmission (D), 62, 63.
- WATERS, W. L.  
 Pioneer Polyphase Transmission (D), 8.  
 High-Tension Transformers (D), 21, 22.







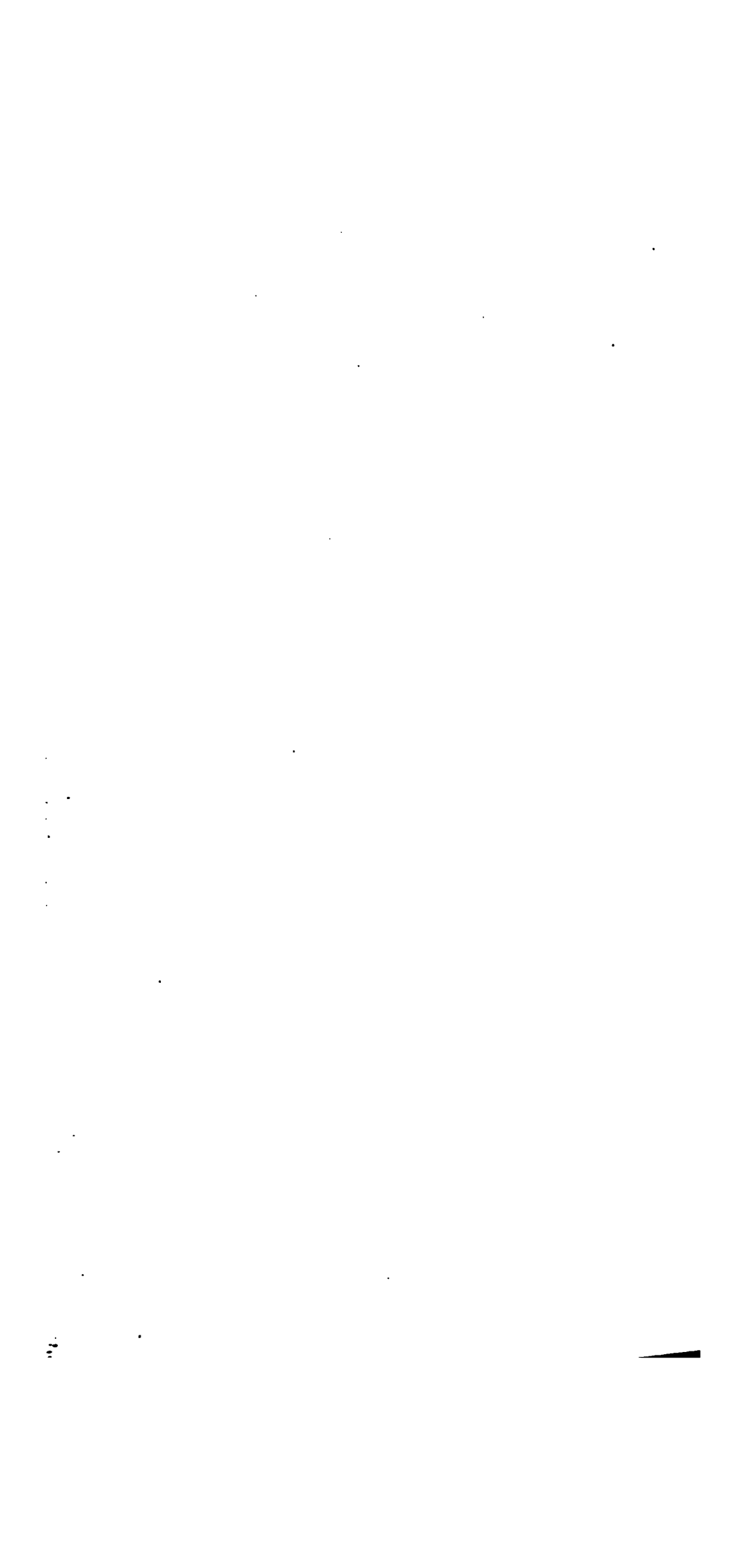







MAR 1 2 1992

